



Civilization of Beauty

CATALOGO GENERALE

---

2021



Civilization of Beauty



## SOMMARIO

Contents . Sommaire . Inhaltsverzeichnis . Sumario . Содержание .

<b>Chi siamo</b> .....	6
About us	
Qui nous sommes	
Über uns	
Quienes somos	
О нас	
<b>Le tappe</b> .....	8
The stages	
Les étapes	
Die Etappen	
Las etapas	
Основные рубежи	
<b>Produzione italiana</b> .....	10
Made in italy	
Production italienne	
Italienische Produktion	
Producción Italiana	
Итальянское производство	
<b>Ecosostenibilità</b> .....	12
Eco-sustainability	
Écodurabilité	
Ökologische Nachhaltigkeit	
Ecosostenibilidad	
Экологическая рациональность	
<b>Perchè scegliere la ceramica?</b> .....	14
Why choose ceramic?	
Pourquoi choisir la céramique <span> </span> ?	
Warum sollte man sich für die keramik entscheiden?	
¿Por qué elegir la cerámica?	
Почему следует выбирать керамику?	
<b>Connubio eccellente tra tradizione ed innovazione</b> .....	16
Excellent combination between tradition and innovation	
Excellente combinaison entre tradition et innovation	
Eine hervorragende Verbindung zwischen Tradition und Innovation	
Excelente combinación entre tradición e innovación	
Великолепное сочетание традиций и инноваций	
<b>Il mondo delle grandi lastre</b> .....	18
Mega slab world	
Les grandes dalles	
Die Welt der großen Platten	
El mundo de las grandes planchas cerámicas	
Мир больших плит	
<b>La gamma dei formati</b> .....	20
Range of sizes	
La gamme des formats	
Die Palette der Formate	
La gama de los formatos	
Предлагаемый ассортимент форматов	

## INDICE PER ASPETTO

Index by look . Par Aspect . Nach Aussehen . Por aspecto . По внешнему виду .

# Legno

Wood . Bois . Hölzer . Maderas . Дерево .

AMAZON.....	26
CA’ FOSCARI.....	40
IL CERRETO.....	54
KAURI.....	70
YOSEMITE.....	78

# Marmo e Pietra

Marble & Stone . Marbres et Pierres . Marmore und Steine . Mármoles y Piedras . Мрамор и Камень .

ARDESIA.....	88
BLUE EVOLUTION.....	104
BORCHI ITALIANI.....	112
CASTLE.....	120
DOLOMITI.....	130
HIGH LINE.....	144
IMPERIAL.....	152
I QUARZI.....	164
JUNGLE STONE.....	176
LE PIETRE D’EUROPA.....	186
MARMI.....	196
PIERRES DES CHÂTEAUX.....	208
PIETRA LAVICA.....	224
ROYAL STONE.....	230
STORM.....	240

## INDICE PER DESTINAZIONE D’USO..... 4

Table of contents broken down according to intended use . Index par destination d’usage . Index für Verwendungszweck . Índice según uso previsto . Оглавление по сфере назначения .

# Materico

Textured . Matièreque . Materisch . Matérico . Фактурная поверхность .

AGGLOMERATE.....	256
ARTILE.....	268
BRUSH.....	280
COTTO DEL CASALE.....	288
FUSION.....	300
LASCAUX.....	308
RA-KU.....	318
RESINE.....	328
SPACE.....	336
STEELISTIC.....	350

# Design

Design . Design . Design . Diseños . Дизайн .

CHROMATIC.....	362
----------------	-----

### PARTE TECNICA - 374

Technical section . Partie technique . Technischer Teil . Parte técnica . Технический раздел .

## OUTDOOR 20 MM..... 376

- 378 **Creare pavimenti senza collanti**  
Create flooring without adhesives  
Créer des carrelages sans colles  
Anfertigung von Böden ohne Kleber

- 380 **Un sistema efficace in ogni condizione**  
An effective system in all situations  
Un système efficace dans toutes conditions  
Ein in jeder Situation effizientes System

- 382 **Massima resistenza per gli spazi carrabili**  
Hardwearing tiles that are ideal for drive-over areas  
Résistance maximale pour les espaces carrossables  
Höchste Beständigkeit für befahrbare Flächen

- 384 **Bellezza e sicurezza per l’area piscina**  
Beauty combined with safety for a perfect pool area  
Beauté et sécurité pour la zone piscine  
Schönheit und Sicherheit in Poolbereichen

- 386 **Outdoor 20 mm: i pezzi speciali**  
20 mm outdoor option: trims.  
Extérieur 20 mm : les pièces spéciales  
Außenbereich 20 mm: die Formteile

- SCHEMI DI POSA.....392  
Laying sketch  
Schémas de pose  
Modulverlegungsbeispiele  
Esquemas de colocación  
Схемы укладки

## CHEVRON.....394

### CARATTERISTICHE TECNICHE..... 400

Technical features  
Caracteristiques techniques  
Technische Eigenschaften  
Características técnicas  
Технические характеристики

### PULIZIA E MANUTENZIONE.....402

Product cleaning and maintenance  
Nettoyage et maintenance du produit  
Reinigung und Pflege des Produktes  
Limpieza y mantenimiento  
Рекомендации по правильной очистке изделия и по уходу за ним

### CONDIZIONI GENERALI DI VENDITA.....404

General sales terms and conditions  
Conditions générales de vente  
Allgemeine Verkaufsbedingungen  
Condiciones generales de venta  
Общие условия продажи

### NOTE GENERICHE SUI PRODOTTI.....408

General information on the products  
Notes générales sur les produits  
Allgemeine Angaben zu den Produkten  
Notas generales sobre los productos  
Общие сведения о продукции

### CERTIFICAZIONI.....409

Certifications  
Certifications  
Zertifikate  
Certificaciones  
Сертификация

## INDICE PER DESTINAZIONE D'USO

Table of contents broken down according to intended use . Index par destination d'usage . Index für Verwendungszweck . Índice según uso previsto . Оглавление по сфере назначения .

### Interni

Interiors . Intérieurs . Innenbereiche .  
Interiores . Интерьеры .

AGGLOMERATE	256
AMAZON	26
ARDESIA	88
ARTILE	268
BLUE EVOLUTION	104
BRUSH	280
CA' FOSCARI	40
CASTLE	120
CHROMATIC	362
COTTO DEL CASALE	288
DOLOMITI	130
FUSION	300
HIGH LINE	144
IL CERRETO	54
IMPERIAL	152
I QUARZI	164
JUNGLE STONE	176
KAURI	70
LASCAUX	308
LE PIETRE D'EUROPA	186
MARMI	196
PIERRES DES CHÂTEAUX	208
PIETRA LAVICA	224
RA-KU	318
RESINE	328
ROYAL STONE	230
SPACE	336
STEELISTIC	350
STORM	240
YOSEMITE	78

### Esterni

Outdoors . Extérieur . Außen .  
Exteriores . Для наружных работ .

ARDESIA	88
BORGHI ITALIANI	112
CA' FOSCARI	40
COTTO DEL CASALE	288
DOLOMITI	130
I QUARZI	164
LE PIETRE D'EUROPA	186
PIERRES DES CHÂTEAUX	208
SPACE	336
STORM	240

### Esterni 20mm

Outdoors . Extérieur . Außen .  
Exteriores . Для наружных работ .

AGGLOMERATE	256
AMAZON	26
ARDESIA	88
BLUE EVOLUTION	104
CA' FOSCARI	40
DOLOMITI	130
IL CERRETO	54
I QUARZI	164
LE PIETRE D'EUROPA	186
PIERRES DES CHÂTEAUX	208
ROYAL STONE	230
SPACE	336
STORM	240

Indoor

Space: Cement 80x80 . (31 1/2"x31 1/2") Nat. Ret.

Outdoor

Space: Cement 80x80 (31 1/2"x31 1/2") Nat. Ret. R11

Space: Cement 80x80 (31 1/2"x31 1/2") 20mm Nat. Ret. R11

Space: Cement Griglia 20 20x80 (8"x31 1/2") 20 mm Nat. Ret. R11



# Chi siamo

About us  
Qui nous sommes  
Über uns  
Quienes somos  
О нас

La Fabbrica S.p.A. è un'azienda leader che produce e commercializza pavimenti e rivestimenti in ceramica italiana di alta gamma. Attraverso i brand LA FABBRICA e AVA per le grandi lastre, si distingue per "alta qualità di prodotto", "design innovativo" e "creatività".

Il fattore eccellenza è la forza ispiratrice che ci distingue in ogni fase di sviluppo: dalla progettazione del prodotto, al laboratorio di ricerca, nei processi di produzione fino alla commercializzazione. Nascono così collezioni all'avanguardia che attraverso le tecnologie più avanzate, consentono di soddisfare le più complesse esigenze tecniche dell'architettura e dell'interior design con stile ed eleganza made in Italy.

La Fabbrica S.p.A. est une entreprise leader qui fabrique et commercialise des carreaux de sol et des revêtements muraux en céramique italienne haut de gamme. À travers les marques LA FABBRICA et AVA pour les grandes dalles, elle se distingue par la « haute qualité du produit », le « design innovant » et la « créativité ».

Le facteur d'excellence est la force inspiratrice qui nous distingue dans chaque phase de développement : de la conception du produit, au laboratoire de recherche, dans les processus de production jusqu'à la commercialisation. C'est ainsi que naissent des collections d'avant-garde qui, grâce aux technologies les plus avancées, permettent de satisfaire les exigences techniques les plus complexes de l'architecture et de la décoration intérieure avec un style et une élégance made in Italy.

A leading name in the ceramics industry, La Fabbrica S.p.A. produces and markets high-end Italian ceramic floor and wall tiles. Through its LA FABBRICA and AVA brands for large slabs, the company has made a name for itself as a manufacturer of superior products offering innovative design and creativity.

Excellence is the force that drives and inspires us through every stage of the development process: from product design to the research laboratory, followed by production and marketing. With this approach, we use pioneering technologies to create avant-garde collections that meet challenging architecture and interior design needs with typical Italian style and elegance.

Die Firma La Fabbrica S.p.A. ist ein führendes Unternehmen, das hochwertige Boden- und Wandbeläge aus italienischer Keramik produziert und vermarktet. Durch die Marken LA FABBRICA und AVA für die großen Platten zeichnet es sich durch "hohe Produktqualität", "innovatives Design" und "Kreativität" aus.

Der Faktor der Erstklassigkeit ist die inspirierende Kraft, die uns in jeder Phase der Entwicklung auszeichnet: vom Produktdesign über das Forschungslabor, in den Produktionsprozessen bis zum Marketing. So entstehen fortschrittliche Kollektionen, die es uns ermöglichen, mit den modernsten Technologien die komplexesten technischen Erfordernisse von Architektur und Interior Design mit Stil und Eleganz Made in Italy zu erfüllen.

La Fabbrica S.p.A. es una empresa líder que produce y comercializa pavimentos y revestimientos en cerámica italiana de alta gama. A través de las marcas LA FABBRICA y AVA para las planchas grandes, se distingue por "alta calidad del producto", "diseño innovador" y "creatividad".

El factor excelencia es la fuerza inspiradora que nos caracteriza en todas las fases de desarrollo: desde el diseño del producto hasta el laboratorio de investigación y desde los procesos de producción hasta la comercialización. Nacen así colecciones de vanguardia que, aplicando las tecnologías más avanzadas, permiten satisfacer los más complejos requerimientos técnicos de la arquitectura y del diseño de interiores con estilo y elegancia Made in Italy.

La Fabbrica S.p.A. - это лидирующая компания, производящая и реализующая итальянскую напольную и облицовочную керамическую плитку премиум-сегмента. Компания имеет бренды LA FABBRICA и AVA (последний специализируется на крупноформатных плитах), которые предлагают креативную продукцию высшего качества с инновационным дизайном.

Стремление к наилучшим результатам является движущей силой каждого этапа развития продукции: от ее разработки и испытаний в исследовательских лабораториях вплоть до производственных процессов и сбыта. Так появляются на свет передовые коллекции, которые благодаря самым современным технологиям могут справиться с наиболее сложными техническими задачами в сфере архитектуры и дизайна интерьеров, предлагая итальянский стиль и элегантность.



# Le tappe

The stages  
Les étapes  
Die Etappen  
Las etapas  
Основные рубежи



Civilization of Beauty

2004

2004  
Nell'ottica di ampliamento e miglioramento delle funzioni logistiche, nel 2004 viene acquistato il primo lotto di terreno nella località di Bagnara di Romagna (RA) vicino al sito di produzione per la realizzazione un nuovo magazzino più fruibile per la spedizione del materiale.

2004  
With the vision of expanding and improving the logistical functions, in 2004 the first plot of land was purchased in the locality of Bagnara di Romagna (RA) near the production site for the construction of a new more usable warehouse for shipping the material.

2004  
Dans le but d'étendre et d'améliorer les fonctions logistiques, en 2004, un premier lot de terrain a été acheté à Bagnara di Romagna (Ravenne) près du site de production pour la construction d'un nouvel entrepôt plus pratique pour l'expédition du matériel.

2004  
Zur Erweiterung und Verbesserung der Logistik wurde im Jahr 2004 in der Nähe der Produktionsstätte ein erstes Grundstück in Bagnara di Romagna (RA) für die Errichtung eines neuen Lagers erworben, mit dem Ziel einer besseren Organisation der Materiallieferungen.

2004  
Dentro de la óptica de ampliación y mejora de las funciones logísticas, en 2004 se compró el primer lote de terreno en la localidad Bagnara di Romagna (RA) cerca de la planta de producción, destinándolo a la instalación de un nuevo almacén más accesible para el envío del material.

2004  
В перспективе расширения и усовершенствования логистических функций в 2004 г. компания приобретает первый земельный участок в городке Баньяра-ди-Романья (провинция Равенна) рядом с местом производства для строительства нового склада для более удобной отгрузки материала.

2012



2012  
Nel 2012 viene introdotto nel mercato il marchio AVA. Le sue collezioni propongono un nuovo lusso dove dettagli e finiture ricercate si alternano alla più raffinata sobrietà e definiscono nuove tendenze nell'interior design.

2012  
In 2012 the AVA brand lanced in the market. Its collections propose a new luxury where details and sophisticated finishes alternate with understated elegance and define new interior design trends.

2012  
En 2012, la marque AVA est introduite sur le marché. Ses collections offrent un nouveau luxe où les détails et les finitions raffinées alternent avec la sobriété la plus raffinée et définissent les nouvelles tendances en matière de décoration d'intérieur.

2012  
2012 wurde die Marke AVA auf dem Markt eingeführt. Ihre Kollektionen bieten Erzeugnisse der Luxus-kategorie, die elegante Ausführungen und Details mit edler Schlichtheit kombinieren und häufig Wegbereiter für neue Trends im Interior Design sind.

2012  
En 2012 se introdujo en el mercado la marca AVA. Sus colecciones proponen un nuevo lujo, donde los detalles y los acabados estudiados se intercalan con la más refinada sobriedad y definen nuevas tendencias en el sector del Diseño de Interiores.

2012  
В 2012 г. на рынок вводится марка AVA. Ее коллекции предлагают новую роскошь, в которой изысканные детали и отделка чередуются с более элегантно строгостью и определяют новые тенденции Дизайна интерьеров.

2014

2014  
Sempre cavalcando le ultime tendenze del momento al Cersaie 2014 il marchio AVA introduce nel mercato il grande formato. Extraordinary Size è il progetto ambizioso di lastre in gres porcellanato tra le più grandi al mondo, 320x160 in soli 6 mm, che sviluppa una varietà di collezioni declinate in molteplici grafiche e sotto formati, perfette per ogni tipo di arredamento e utilizzo (top e piani, porte e ante per mobili, parete ventilate, contract, spa, etc).

2014  
Following the last trends, during Cersaie 2014, the Ava brand introduces the big size. Extraordinary Size is the ambitious project of the largest porcelain stoneware slabs in the world, 320x160 cm with a thickness of only 6 mm which develops a wide range of collections declined in a great variety of graphics and smaller sizes, ideal for any type of furniture and application (tops, doors and doors for furniture, ventilated walls, contract, spa, etc).

2014  
Toujours à l'affût des dernières tendances au Cersaie 2014, la marque AVA introduit le grand format sur le marché. Extraordinary Size est le projet ambitieux de certaines des plus grandes dalles de grès cérame du monde, 320x160 en seulement 6 mm, qui développe une variété de collections dans une variété de graphismes et de formats, parfaits pour tout type d'ameublement et d'utilisation (plans et dessus, portes et vantaux pour meubles, murs ventilés, collectivité, spa, etc.)

2014  
Stets auf der Höhe mit den neuesten Trends brachte AVA anlässlich der Messe Cersaie 2014 ihre großformatigen Fliesen auf den Markt. Das ehrgeizige Projekt Extraordinary Size besteht aus Steinzeugplatten, die zu den größten der Welt gehören: 320x160 cm mit lediglich 6 mm Stärke. Es umfasst eine Reihe verschiedener Kollektionen mit unterschiedlichen Mustern und Unterformaten, die für jede Art von Einrichtung und Nutzung geeignet sind (Flächen und Arbeitsplatten, Türen für Möbel, hinterlüftete Wände, Contract-Bereich, SPA usw.).

2014  
Proponiendo siempre las últimas tendencias, en Cersaie 2014 la marca AVA introdujo en el mercado el gran formato. Extraordinary Size es el ambicioso proyecto de las más grandes placas de gres porcelánico, 320x160 con solo 6 mm de espesor, que desarrolla una variedad de colecciones combinadas con múltiples gráficas y sub-formatos, perfectas para todo tipo de decoración y uso (encimeras y superficies, puertas para muebles, paredes ventiladas, contract, spa, etc.).

2014  
Ostavаясь всегда на гребне последних тенденций, на выставке Cersaie 2014 марка AVA вводит на рынок крупноформатную плитку. Extraordinary Size – это амбициозный проект одних из самых крупных в мире керамогранитных плит размером 320x160 и толщиной всего 6 мм, который включает разнообразные коллекции с самым разным графическим рисунком и в подформатах, идеально подходящих для любого типа мебели и вида использования (топы и столешницы, двери и створки для мебели, вентилируемые стены, контрактная мебель, spa-центры и тд.).

2017

2017  
A maggio 2017, La Fabbrica Ceramiche è parte della Holding Italcir Group S.p.A., azienda creata dal Fondo Italiano di private Equity Mandarin Capital Partners II, guidata dal CEO Graziano Verdi, col fine di creare un polo di lusso nel settore della ceramica Made in Italy di alta gamma.

2017  
In May 2017, La Fabbrica Ceramiche became part of Holding Italcir Group spa, a holding company created by the Italian private equity fund Mandarin Capital Partners II, headed by CEO Graziano Verdi. The Group's objective is to create a luxury cluster in the high-end ceramic sector.

2017  
En mai 2017, La Fabbrica Ceramiche fait partie de Holding Italcir Group S.p.A., une société créée par le Fonds Italien de private Equity Mandarin Capital Partners II, dirigée par le PDG Graziano Verdi, dans le but de créer un pôle de luxe dans le secteur de la céramique haut de gamme Made in Italy.

2017  
Seit Mai 2017 gehört La Fabbrica Ceramiche zur Holding Italcir Group S.p.A. Das Unternehmen unter der Leitung des CEO Graziano Verdi wurde vom italienischen Private-Equity Fonds Mandarin Capital Partners II mit dem Ziel gegründet, ein Luxussegment für hochwertige Keramikerzeugnisse "Made in Italy" zu schaffen.

2017  
Desde mayo de 2017, La Fabbrica Ceramiche entra a formar parte del Holding Italcir Group S.p.A., empresa creada por el Fondo Italiano de empresas privadas Equity Mandarin Capital Partners II, dirigidas por el CEO Graziano Verdi, con el objetivo de crear un polo de lujo en el sector de la cerámica de alta gama Made in Italy.

2017  
В мае 2017 г. La Fabbrica Ceramiche становится частью Holding Italcir Group S.p.A., компании, созданной Итальянским фондом Private Equity Mandarin Capital Partners II и управляемой главным исполнительным директором Грациано Верди, с целью создания центра роскоши в секторе керамики Made in Italy высокого ценового сегмента.

2020



2020  
Nascono la nuova sede e la nuova sala mostra. A fine 2020 è stato firmato un accordo tra il gruppo Italcir e Tonino Lamborghini con il quale La Fabbrica seguirà la produzione e la commercializzazione della nuova collezione Tonino Lamborghini Luxury Surfaces.

2020  
The new headquarters and the new showroom were opened. An agreement was signed at the end of 2020 between the Italcir group and Tonino Lamborghini with which La Fabbrica will follow the production and marketing of the new Tonino Lamborghini Luxury Surfaces collection.

2020  
Ouverture du nouveau siège et du nouveau hall d'exposition. Fin 2020, un accord a été signé entre le groupe Italcir et Tonino Lamborghini aux termes duquel La Fabbrica suivra la production et la commercialisation de la nouvelle collection Tonino Lamborghini Luxury Surfaces.

2020  
Der neue Sitz und der neue Ausstellungsraum entstehen. Ende 2020 wurde zwischen der Italcir-Gruppe und Tonino Lamborghini eine Vereinbarung unterzeichnet, mit der La Fabbrica die Produktion und Vermarktung der neuen Kollektion Tonino Lamborghini Luxury Surfaces übernehmen wird.

2020  
Son inauguradas la nueva sede y la nueva sala de exposición. A fines de 2020 se ha firmado un acuerdo entre el Grupo Italcir y Tonino Lamborghini, mediante el cual La Fabbrica se ocupará de la producción y la comercialización de la nueva colección Tonino Lamborghini Luxury Surfaces.

2020  
Открываются новый головной офис и новый выставочный зал. В конце 2020 г. группа Italcir и Tonino Lamborghini подписали соглашение, на основе которого La Fabbrica займется производством и сбытом новой коллекции Tonino Lamborghini Luxury Surfaces.

# Produzione italiana

Made in Italy  
Production italienne  
Italienische Produktion  
Producción Italiana  
Итальянское производство

La Fabbrica storicamente ha sempre pensato "il bello" e disegna ceramiche per i brand Ava e La Fabbrica guidata dai concetti di bellezza e di eleganza tipici del Made in Italy.

La fantasia delle grafiche e la cura di ogni singolo dettaglio (materia, colore, struttura, forma, imballo, servizio, comunicazione, merchandising) sono accompagnate da una elevata attenzione alla qualità di realizzazione delle piastrelle e delle lastre La Fabbrica e Ava.

L'innovazione di prodotto (bello, unico, affidabile, distintivo) è frutto della stretta sinergia tra i diversi reparti di La Fabbrica quali R&D, marketing, produzione, qualità, che trovano spesso ispirazione anche grazie alla collaborazione con importanti architetti e designer di fama mondiale, quali Doriana e Massimiliano Fuksas e Massimo Iosa Ghini.

Historiquement, La Fabbrica a toujours pensé « le beau » et conçoit des céramiques pour les marques Ava et La Fabbrica en s'inspirant des concepts de beauté et d'élégance typiques du Made in Italy.

La fantaisie du graphisme et le soin apporté à chaque détail (matière, couleur, structure, forme, emballage, service, communication, merchandising) s'accompagnent d'une grande attention à la qualité de réalisation des carreaux et des dalles La Fabbrica et Ava.

L'innovation du produit (beau, unique, fiable, distinctif) est le résultat de l'étroite synergie entre les différents départements de La Fabbrica tels que la R&D, le marketing, la production, la qualité dont l'inspiration provient également de la collaboration avec d'importants architectes et designers de renommée mondiale, tels que Doriana et Massimiliano Fuksas et Massimo Iosa Ghini.

Historically, La Fabbrica has always built ceramics for the Ava and La Fabbrica brands on the notion of "beauty" and designs, guided by the concepts of beauty and elegance which are typical of Italian-made products.

The fantasy of the graphics and the attention to every single detail (material, colour, structure, shape, packaging, service, communication, merchandising) are accompanied by a high level of attention to the quality of the production of La Fabbrica and Ava tiles and slabs.

Product innovation (beautiful, unique, reliable, distinctive) is the result of the close synergy between the different departments of La Fabbrica, such as R&D, Marketing, Production and Quality, which often find inspiration also thanks to the collaboration with important architects and renowned global designers, such as Doriana and Massimiliano Fuksas and Massimo Iosa Ghini.

Traditionell hat La Fabbrica immer an „das Schöne“ gedacht und entwirft Keramik für die Marken Ava und La Fabbrica, die sich an den für das Made in Italy typischen Konzepten von Schönheit und Eleganz orientiert.

Die Fantasie bei den Grafiken und die Sorgfalt bei jedem einzelnen Detail (Material, Farbe, Struktur, Form, Verpackung, Service, Kommunikation, Merchandising) werden von einem hohen Maß an Aufmerksamkeit hinsichtlich der Qualität bei der Herstellung der Fliesen und Platten von La Fabbrica und Ava begleitet.

Die Produktinnovation (schön, einzigartig, zuverlässig, unverwechselbar) ist das Ergebnis des engen Zusammenwirkens zwischen den verschiedenen Abteilungen von La Fabbrica, wie F&E, Marketing, Produktion und Qualität, die häufig auch durch die Zusammenarbeit mit bedeutenden Architekten und Designern mit Weltruhm Inspiration finden, wie Doriana und Massimiliano Fuksas sowie Massimo Iosa Ghini.

La Fabbrica históricamente ha pensado siempre "lo bello" y diseña cerámicas para las marcas Ava y La Fabbrica, orientándose en pos de los conceptos de belleza y elegancia, típicos del Made in Italy.

La fantasía de las gráficas y la atención prestada a cada detalle (materia, color, estructura, forma, embalaje, servicio, comunicación, técnica de comercialización) son acompañadas por una elevada atención a la calidad de realización de las baldosas y planchas de La Fabbrica y Ava.

La innovación del producto (bello, único, confiable, característico) es fruto de la estrecha sinergia entre las diferentes secciones de La Fabbrica tales como investigación y desarrollo (I&D), mercadotecnia, producción y calidad, que encuentran con frecuencia inspiración gracias a la colaboración con importantes arquitectos y diseñadores de fama mundial, tales como Doriana y Massimiliano Fuksas y Massimo Iosa Ghini.

В течение всей ее истории La Fabbrica постоянно работала над красотой. Она разрабатывает керамические изделия для брендов Ava и La Fabbrica, руководствуясь принципами красоты и элегантности, характерными для продукции "Made in Italy".

Креативность графического оформления и тщательная проработка каждой отдельной детали (материал, цвет, структура, форма, упаковка, поддержка, коммуникация, мерчандайзинг) сопровождаются пристальным вниманием, которое уделяется качеству производства плитки и плит брендов La Fabbrica и Ava.

Инновационные характеристики продукции (красота, уникальность, надежность, узнаваемость) являются результатом сплоченной работы разных подразделений La Fabbrica, например, отдел исследований и развития, отдел маркетинга, производственный отдел, отдел обеспечения качества, для которых часто источником вдохновения является сотрудничество со знаменитыми архитекторами и известными во всем мире дизайнерами, такими как Дориана и Массимилиано Фукас, Массимо Йоза Гини.



Evento Maxxi:  
performance di Doriana e Massimiliano Fuksas su lastre Scratch di Ava.

Maxxi Event:  
performance by Doriana and Massimiliano Fuksas on Ava Scratch slabs.

Événement Maxxi :  
performance de Doriana et Massimiliano Fuksas sur les dalles Scratch d'Ava.

Veranstaltung Maxxi:  
Performance von Doriana und Massimiliano Fuksas auf Platten Scratch von Ava.

Evento Maxxi:  
performance de Doriana y Massimiliano Fuksas sobre planchas Scratch de Ava.

Мероприятие Maxxi:  
перформанс Дорианы и Массимилиано Фукас на плитах Scratch от Ava.

ITALIAN DESIGN & MADE IN ITALY



Bologna Design Week 2019: Human Proportion project di Massimo Iosa Ghini, realizzato insieme a La Fabbrica con i rivestimenti interni ed esterni di Ava e La Fabbrica.

Bologna Design Week 2019: Human Proportion project by Massimo Iosa Ghini, created together with La Fabbrica with the internal and external tiles by Ava and La Fabbrica.

Bologna Design Week 2019 : Human Proportion project de Massimo Iosa Ghini, créé avec des revêtements pour l'intérieur et l'extérieur d'Ava et de La Fabbrica.

Bologna Design Week 2019: Das Human Proportion Project von Massimo Iosa Ghini, erstellt zusammen mit La Fabbrica und den Boden- und Wandbelägen für Innen- und Außenbereiche von Ava und La Fabbrica.

Semana del Diseño de Bolonia 2019: Proyecto de Proporciones Humanas de Massimo Iosa Ghini, realizado en conjunto con La Fabbrica, con revestimientos de interiores y exteriores de Ava y La Fabbrica.

Неделя дизайна 2019 в Болонье: проект "Human Proportion" от Массимо Йоза Гини, выполненный вместе с La Fabbrica с применением материалов брендов Ava и La Fabbrica для внутренней и наружной облицовки.

# Ecosostenibilità

Eco-sustainability  
Écodurabilité  
Ökologische Nachhaltigkeit  
Ecosostenibilidad  
Экологическая рациональность

La sostenibilità ambientale è uno dei pilastri del Gruppo Italcner, dalla scelta delle materie prime al processo produttivo.

L'azienda si distingue per gli importanti investimenti nell'industria 4.0, una filiera altamente tecnologica che abbatte le emissioni e trasforma gran parte degli scarti di lavorazione per convertirli in materia prima riutilizzabile. Il risultato è un prodotto green di alta gamma e design.

La durabilité environnementale est l'un des piliers du Groupe Italcner, du choix des matières premières au processus de production.

L'entreprise se distingue par ses investissements importants dans l'industrie 4.0, une chaîne d'approvisionnement de haute technologie qui réduit les émissions et transforme une grande partie des déchets de fabrication en matière première réutilisable. Le résultat est un produit écologique haut de gamme et design.

Environmental sustainability is one of the pillars of the Italcner Group, from the choice of raw materials to the production process.

The company stands out for its important investments in industry 4.0, a highly technological supply chain that reduces emissions and transforms most of the processing waste to convert it into reusable raw material. The result is a high-end green and design product.

Die ökologische Nachhaltigkeit ist eine der Säulen der Italcner Group, von der Auswahl der Rohstoffe bis zum Produktionsprozess.

Das Unternehmen zeichnet sich durch bedeutende Investitionen in Industrie 4.0 aus, einer hochtechnologischen Lieferkette, die Emissionen reduziert und den größten Teil der Verarbeitungsabfälle in wiederverwendbare Rohstoffe umwandelt. Das Ergebnis ist ein umweltfreundliches High-End- und Designprodukt.

La sostenibilidad ambiental es uno de los pilares del Grupo Italcner y ello desde la elección de las materias primas hasta el proceso de producción.

La compañía se destaca por sus importantes inversiones en la industria 4.0, con una cadena de suministro altamente tecnológica que reduce las emisiones y transforma gran partes de los desechos de procesamiento para convertirlos en materia prima reutilizable. El resultado es un producto verde de alta gama y diseño.

Экологическая рациональность является одним из основных руководящих принципов деятельности Группы Italcner, начиная от отбора сырья и вплоть до производственного процесса.

Компания сделала большие капиталовложения в индустрию 4.0, то есть, в высокотехнологичную производственную цепочку, снижающую выбросы и перерабатывающую большинство производственных отходов, которые превращаются в повторно используемое сырье. Результат - экологичная, дизайнерская продукция высокого качества.



# Perché scegliere la ceramica?

Why choose ceramic?

Pourquoi choisir la céramique ?

Warum sollte man sich für die keramik entscheiden?

¿Por qué elegir la cerámica?

Почему следует выбирать керамику?



## Sicura, sostenibile, versatile e raffinata: Un'eccellenza italiana dalle qualità impareggiabili

Safe, sustainable, versatile and refined: italian excellence with unbeatable qualities.

Sûre, durable, polyvalente et raffinée : une excellence italienne avec des qualités uniques.

Sicher, nachhaltig, vielseitig und raffiniert: Ein hervorragendes italienisches erzeugnis mit unvergleichlichen Eigenschaften.

Segura, sustentable, versátil y refinada: una excelencia italiana de cualidades inigualables.

Надежная, экологичная, практичная и изысканная, итальянское совершенство с несравненными качествами.



**SALUBRE.**  
HEALTHY.  
SALUBRE.  
GESUND.  
SALUBRE.  
ЗДОРОВАЯ.



**RESISTE ALLE MACCHIE.**  
STAINPROOF.  
RÉSISTE AUX TACHES.  
FLECKENBESTÄNDIG.  
RESISTENTE A LAS MANCHAS.  
ПЯТНОСТОЙКИЙ.



**FACILE DA PULIRE**  
EASY TO CLEAN.  
FACILE A NETTOYER.  
LEICHT ZU REINIGEN.  
FÁCIL DE LIMPIAR.  
ЛЕГКО ОЧИЩАЕТСЯ.



**RESISTE AGLI ACIDI.**  
ACID-RESISTANT.  
RÉSISTE AUX ACIDES.  
SÄUREBESTÄNDIG.  
RESISTENTE A LOS ÁCIDOS.  
КИСЛОТОСТОЙКИЙ.



**NON ASSORBE.**  
NON ABSORBENT.  
NON ABSORBANT.  
ABSORBIERT NICHT.  
NO ABSORBE.  
НЕ ВПИТЫВАЮЩАЯ.



**\* IGIENICO, IDEALE AL CONTATTO CON GLI ALIMENTI.**  
HYGIENIC, SUITABLE FOR CONTACT WITH FOOD.  
HYGIÉNIQUE, IDÉAL POUR LE CONTACT AVEC LES ALIMENTS.  
HYGIENISCH, IDEAL BEIM KONTAKT MIT LEBENSMITTELN.  
HIGIÉNICO, IDEAL PARA CONTACTO CON ALIMENTOS.  
ГИГИЕНИЧНЫЙ, СОВЕРШЕННО БЕЗОПАСНЫЙ ПРИ КОНТАКТЕ С ПИЩЕВЫМИ ПРОДУКТАМИ.

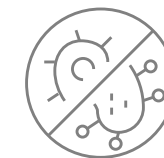

**NON È ATTACCABILE DA FUNGHI E MUFFE**  
RESISTANT TO MOULD AND MILDEW.  
RÉSISTE À L'AGRESSION DES CHAMPIGNONS ET DES MOISSISSURES.  
WIRD NICHT VON PILZEN UND SCHIMMEL ANGEGRIFFEN.  
INATACABLE POR HONGOS Y MOHOS.  
НЕ ПОДВЕРГАЕТСЯ ВОЗДЕЙСТВИЮ ГРИБКОВ И ПЛЕСЕНИ.



**PRODOTTO NEL RISPETTO DELL'AMBIENTE E RICICLABILE.**  
PRODUCED IN RESPECT OF THE ENVIRONMENT AND RECYCLABLE.  
PRODUIT DANS LE RESPECT DE L'ENVIRONNEMENT ET RECYCLABLE.  
HERGESTELLT UNTER SCHUTZ DER UMWELT UND RECYCLFÄHIG.  
PRODUCIDO CON RESPETO DEL AMBIENTE Y RECICLABLE.  
ПРОДУКЦИЯ, УВАЖАЮЩАЯ ПРИРОДУ И ПОВТОРНО ПЕРЕРАБАТЫВАЕМАЯ.



**INALTERABILE NEL TEMPO.**  
GUARANTEED STABILITY OVER TIME.  
INALTÉRABLE DANS LE TEMPS.  
DAUERHAFT UNVERÄNDERLICH.  
INALTERABLE A LARGO PLAZO.  
НЕ ИЗМЕНЯЕТСЯ С ТЕЧЕНИЕМ ВРЕМЕНИ.

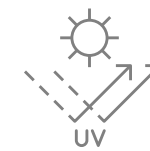

**RESISTE AI RAGGI UV.**  
UV-RESISTANT.  
RÉSISTE AUX RAYONS UV.  
BESTÄNDIG GEGENÜBER UV-STRAHLEN.  
RESISTENTE A LOS RAYOS UV.  
ВЫДЕРЖИВАЕТ УФ-ИЗЛУЧЕНИЕ.



**NON SI USURA.**  
NOT PRONE TO WEAR.  
NE S'USE PAS.  
NUTZT SICH NICHT AB.  
RESISTENTE A LOS RAYOS UV.  
НЕ ИЗНАШИВАЕТСЯ.



**NON SI GRAFFIA.**  
SCRATCHPROOF.  
NE RAYE PAS.  
KRATZBESTÄNDIG.  
NO SE RAYA.  
НЕ ЦАРАПАЕТСЯ.

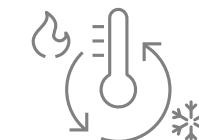

**NON TEME GLI SBALZI TERMICI.**  
WITHSTANDS SUDDEN TEMPERATURE CHANGES.  
NE CRAINT PAS LES ÉCARTS THERMIQUES.  
BESTÄNDIG GEGEN TEMPERATURSCHWANKUNGEN.  
NO TEME LAS OSCILACIONES TÉRMICAS.  
НЕ БОИТСЯ ПЕРЕПАДОВ ТЕМПЕРАТУРЫ.

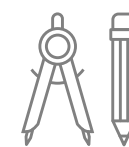

**VERSATILITÀ DI PROGETTO.**  
DESIGN VERSATILITY.  
POLYVALENCE DU PROJET.  
VIELSEITIGKEIT DES ENTWURFS.  
VERSATILIDAD DE PROYECTO.  
ПРОЕКТНАЯ ГИБКОСТЬ.



**IDEALE PER INTERNI ED ESTERNI.**  
IDEAL FOR INDOOR AND OUTDOOR USE.  
IDÉAL POUR L'INTÉRIEUR ET L'EXTÉRIEUR.  
IDEAL FÜR INNEN- UND AUSSENBEREICHE.  
IDEAL PARA INTERIORES Y EXTERIORES.  
ИДЕАЛЬНО ПОДХОДИТ ДЛЯ ВНУТРЕННИХ И НАРУЖНЫХ РАБОТ.

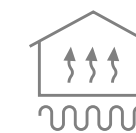

**IDEALE PER RISCALDAMENTO A PAVIMENTO.**  
IDEAL FOR FLOOR HEATING.  
PARFAIT POUR LE CHAUFFAGE PAR LE SOL.  
IDEAL FÜR FUSSBODENHEIZUNG.  
IDEAL PARA CALEFACCIÓN POR PAVIMENTO.  
ОТЛИЧНО ПОДХОДЯЩАЯ ДЛЯ УСТРОЙСТВА ТЕПЛЫХ ПОЛОВ.



**IGNIFUGO.**  
FIREPROOF.  
IGNIFUGE.  
FEUERFEST.  
IGNÍFUGO.  
НЕГОРЮЧАЯ.

**\* Tutte le lastre sono certificabili MOCA.**

All slab are MOCA certified.

Tous les dalles peuvent accéder au classement MOCA.

Alle Platten sind nach MOCA zertifizierbar.

Todas las planchas pueden ser certificadas MOCA.

На все плиты может выдаваться сертификат MOCA.



# Connubio eccellente tra tradizione ed innovazione

Excellent combination between tradition and innovation  
Excellente combinaison entre tradition et innovation  
Eine hervorragende Verbindung zwischen Tradition und Innovation  
Excelente combinación entre tradición e innovación  
Великолепное сочетание традиций и инноваций

Grazie al marchio La Fabbrica, l'Azienda propone prodotti esclusivi ed all'avanguardia nella tecnologia e nel design: impianti di produzione di ultima generazione realizzano collezioni esteticamente ricercate nonché disponibili sia nel grande formato fino a 80x180 che nel piccolo 20x20.

Le collezioni LA FABBRICA sono inoltre disponibili sia per interno che per esterno in diversi spessori ed idonee sia per ambienti residenziali che commerciali.

Thanks to the La Fabbrica brand, the company offers exclusive and cutting-edge products in technology and design: the latest generation of production systems create aesthetically refined collections, which are also available in both large sizes up to 80x180 and small 20x20.

The LA FABBRICA collections are also available for indoor and outdoor use in different thicknesses and suitable for both home and commercial environments.

Grâce à la marque La Fabbrica, le Groupe propose des produits exclusifs en technologie et design: les usines de production de dernière génération créent également des collections esthétiquement raffinées disponibles à la fois en grand format jusqu'à 80x180 en partant du 20x20.

Les collections LA FABBRICA sont également disponibles pour l'intérieur et pour l'extérieur en différentes épaisseurs, conformes pour le résidentiel et le public.

Dank der Marke La Fabbrica bietet das Unternehmen exklusive Produkte auf dem neuesten Stand von Technologie und Design an: Produktionsanlagen der neuesten Generation stellen ästhetisch raffinierte Kollektionen her, die sowohl im großen Format von bis zu 80x180 als auch in kleinen 20x20 erhältlich sind.

Die Kollektionen LA FABBRICA sind sowohl für den Innen- als auch für den Außenbereich in unterschiedlichen Stärken erhältlich und sowohl für Wohn- als auch für Geschäftsbereiche geeignet.

Gracias a la marca La Fabbrica, la Empresa propone productos exclusivos y de vanguardia en cuanto a tecnología y diseño: plantas de producción de última generación realizan colecciones estéticamente refinadas, disponibles tanto en el gran formato de hasta 80x180 como en el pequeño de 20x20.

Asimismo, las colecciones LA FABBRICA se encuentran disponibles para interiores y para exteriores, en diferentes espesores y apropiadas para ambientes tanto comerciales como residenciales.

Под брендом La Fabbrica компания выпускает эксклюзивную продукцию с передовыми характеристиками технологичности и дизайна: производственные системы нового поколения создают коллекции с изысканной эстетикой, которые предлагаются как в крупных форматах (вплоть до 80x180 см), так и небольших размеров (20x20 см).

Кроме того, коллекции бренда LA FABBRICA доступны как для внутренней, так и для наружной укладки, выпускаются с разными значениями толщины и могут применяться как в жилом, так и в коммерческом строительстве.



Civilization of Beauty



# Il mondo delle grandi lastre

Mega slab world  
Les grandes dalles  
Die Welt der großen Platten  
El mundo de las grandes planchas cerámicas  
Мир больших плит



Alla necessità dell'architettura contemporanea di creare progetti sempre più ambiziosi, Ava risponde con soluzioni innovative in gres porcellanato che cambiano il modo di progettare gli ambienti.

Attraverso le grandissime lastre 320x160 cm gli spazi si rivestono di una nuova idea comune ma sempre originale e differente, capace di definire con stile le superfici più disparate: dal pavimento al rivestimento di pareti e porte, mobili, piani cucina a lastre in 12 mm di spessore ed ante e altri progetti speciali

AVA meets the need in contemporary architecture to create ever more ambitious projects, with its innovative porcelain stoneware solutions that change the way interiors and exteriors are designed.

The extra-large (320x160 cm) slabs offer a material that can be used across the board, in any area, to create original, different and stylish designs, from the floor to the walls and even doors, furniture, kitchen tops (with the 12 mm thick slabs) and cabinet doors and other special projects.

Au besoin de l'architecture contemporaine pour créer des projets toujours plus ambitieux, Ava répond avec des solutions innovantes en gres cérame qui changent la façon dont nous concevons l'environnement.

Grâce aux très grandes dalles de 320x160 cm, les espaces sont recouverts d'une nouvelle idée commune mais toujours originale et différente, capable de définir avec style les surfaces les plus différentes: du sol au revêtement des murs et des portes, des meubles, des plans de travail de cuisine avec dalles en 12 mm d'épaisseur etc..

Ava reagiert auf die Notwendigkeit der modernen Architektur, immer ehrgeizigere Projekte zu verwirklichen, mit innovativen Lösungen aus Feinsteinzeug, die die Art und Weise der Raumgestaltung verändern.

Durch die sehr großen Platten von 320 x 160 cm werden die Räume mit einer neuen gemeinsamen Idee gekleidet, die in der Lage ist, die verschiedensten Oberflächen mit Stil zu gestalten: vom Boden- über den Wandbelag bis zur Verkleidung von Türen, Möbeln, Küchenarbeitsplatten in der Stärke von 12 mm sowie Türflügeln und anderen speziellen Projekten

A la necesidad de la arquitectura contemporánea en cuanto a crear proyectos cada vez más ambiciosos, Ava responde con soluciones innovadoras en gres porcelánico que cambian el modo de diseñar los ambientes.

Mediante las grandísimas planchas de 320x160 cm, los espacios se revisten con una nueva idea común pero siempre original y diferente, capaz de definir con estilo las superficies más diferentes: desde el pavimento hasta el revestimiento de paredes, puertas, muebles, encimeras de cocina con planchas de 12 mm de espesor, además de puertas de armarios y otros proyectos especiales.

На требования современной архитектуры, создающей все более амбициозные проекты, Ava отвечает инновационными решениями из керамогранита, которые изменяют подход к проектированию интерьеров.

Благодаря плитам очень больших размеров (320x160 см) можно отделять пространства новым, общим, но всегда оригинальным и неповторяющимся материалом, стильно оформляя самые разнообразные поверхности: пол, стены, двери, мебель, кухонные столешницы (используя плиты толщиной 12 мм), створки для мебели и другие специальные проекты.



# La gamma dei formati

Range of sizes  
 La gamme des formats  
 Die Palette der Formate  
 La gama de los formatos  
 Предлагаемый ассортимент форматов

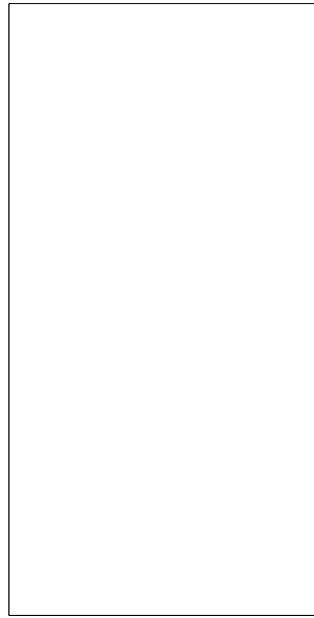

**324x163**  
 127"x64"  
 AVA - Absolute  
 AVA - Bardiglio Cenere  
 AVA - Calacatta  
 AVA - City  
 AVA - Statuario Splendente

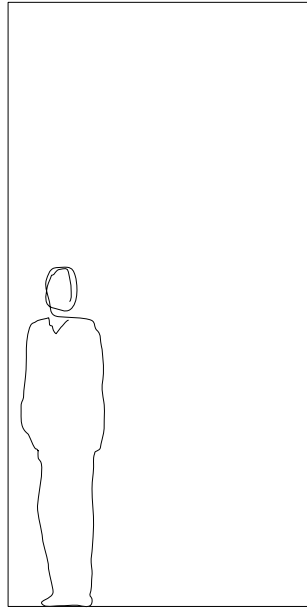

**320x160**  
 126"x63"  
 AVA - Aesthetica  
 AVA - Absolute  
 AVA - Ardesia  
 AVA - Azul Macauba  
 AVA - Bardiglio Cenere  
 AVA - Bronze Amani  
 AVA - Calacatta  
 AVA - Copacabana  
 AVA - Crema Marfil  
 AVA - C-Stone  
 AVA - District  
 AVA - Lasa  
 AVA - Metal  
 AVA - Nautilus  
 AVA - Nero Belvedere  
 AVA - Onice Serpentino  
 AVA - Onice Smeraldo  
 AVA - Pireni  
 AVA - Portoro  
 AVA - Scratch  
 AVA - Skyline  
 AVA - Statuario  
 AVA - Statuario Splendente  
 AVA - Taj Mahal  
 AVA - Tortoise  
 AVA - Travertino Classic  
 AVA - White Macauba

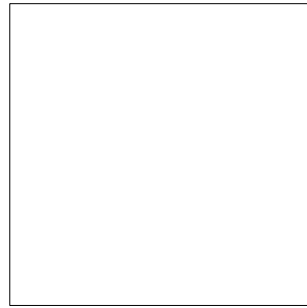

**160x160**  
 63"x63"  
 AVA - Aesthetica  
 AVA - Absolute  
 AVA - Ardesia  
 AVA - Azul Macauba  
 AVA - Bardiglio Cenere  
 AVA - Bronze Amani  
 AVA - Calacatta  
 AVA - Crema Marfil  
 AVA - C-Stone  
 AVA - District  
 AVA - Lasa  
 AVA - Metal  
 AVA - Nautilus  
 AVA - Nero Belvedere  
 AVA - Onice Serpentino  
 AVA - Onice Smeraldo  
 AVA - Pireni  
 AVA - Portoro  
 AVA - Scratch  
 AVA - Skyline  
 AVA - Statuario  
 AVA - Statuario Splendente  
 AVA - Taj Mahal  
 AVA - Tortoise  
 AVA - Travertino Classic  
 AVA - White Macauba

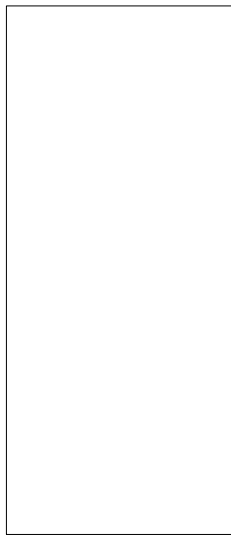

**280x120**  
 110"x48"  
 AVA - Ardesia  
 AVA - Bronze Amani  
 AVA - C-Stone  
 AVA - Metal  
 AVA - Onice Serpentino  
 AVA - Taj Mahal  
 AVA - Tortoise

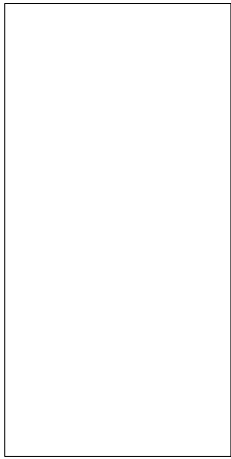

**240x120**  
 96"x48"  
 AVA - Aesthetica  
 AVA - Absolute  
 AVA - Azul Macauba  
 AVA - Bardiglio Cenere  
 AVA - Calacatta  
 AVA - Copacabana  
 AVA - Crema Marfil  
 AVA - District  
 AVA - Lasa  
 AVA - Nautilus  
 AVA - Nero Belvedere  
 AVA - Onice Smeraldo  
 AVA - Portoro  
 AVA - Skyline  
 AVA - Statuario  
 AVA - Statuario Splendente  
 AVA - Travertino Classic  
 AVA - White Macauba

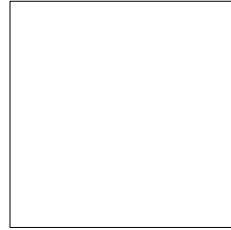

**120x120**  
 48"x48"  
 AVA - Aesthetica  
 AVA - Absolute  
 AVA - Azul Macauba  
 AVA - Bardiglio Cenere  
 AVA - Calacatta  
 AVA - Copacabana  
 AVA - Crema Marfil  
 AVA - District  
 AVA - Lasa  
 AVA - Nautilus  
 AVA - Nero Belvedere  
 AVA - Onice Smeraldo  
 AVA - Portoro  
 AVA - Skyline  
 AVA - Statuario  
 AVA - Statuario Splendente  
 AVA - Travertino Classic  
 AVA - White Macauba  
 La Fabbrica - Agglomerate  
 La Fabbrica - Imperial  
 La Fabbrica - Jungle Stone

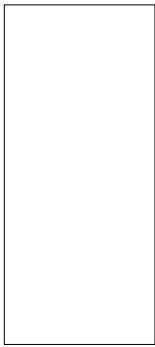

**180x80**  
 71"x31 1/2"  
 AVA - Lasa  
 AVA - Onice Serpentino  
 AVA - White Macauba  
 La Fabbrica - Castle  
 La Fabbrica - Marmi  
 La Fabbrica - Space  
 La Fabbrica - Storm

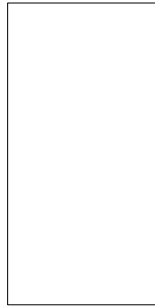

**160x80**  
 63"x31 1/2"  
 AVA - Aesthetica  
 AVA - Absolute  
 AVA - Ardesia  
 AVA - Azul Macauba  
 AVA - Bardiglio Cenere  
 AVA - Bronze Amani  
 AVA - Calacatta  
 AVA - Copacabana  
 AVA - Crema Marfil  
 AVA - C-Stone  
 AVA - District  
 AVA - Lasa  
 AVA - Metal  
 AVA - Nautilus  
 AVA - Nero Belvedere  
 AVA - Onice Serpentino  
 AVA - Onice Smeraldo  
 AVA - Pireni  
 AVA - Portoro  
 AVA - Scratch  
 AVA - Skyline  
 AVA - Statuario  
 AVA - Statuario Splendente  
 AVA - Taj Mahal  
 AVA - Tortoise  
 AVA - Travertino Classic  
 AVA - White Macauba

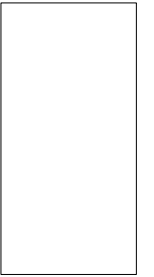

**120x60**  
 48"x24"  
 AVA - Aesthetica  
 AVA - Absolute  
 AVA - Azul Macauba  
 AVA - Bardiglio Cenere  
 AVA - Calacatta  
 AVA - Copacabana  
 AVA - Crema Marfil  
 AVA - Lasa  
 AVA - Metal  
 AVA - Nero Belvedere  
 AVA - Onice Serpentino  
 AVA - Portoro  
 AVA - Scratch  
 AVA - Skyline  
 AVA - Statuario  
 AVA - Statuario Splendente  
 AVA - Travertino Classic  
 AVA - White Macauba

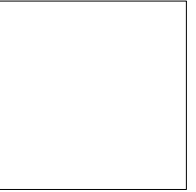

**100x100**  
 40"x40"  
 AVA - Skyline  
 La Fabbrica - Le Pietre d'Europa  
 La Fabbrica - Pierres des Chateaux



**50x100**  
 20"x40"  
 La Fabbrica - Le Pietre d'Europa



**23x149**

9"x58 1/2"

La Fabbrica - Il Cerreto



**30x120**

12"x48"

La Fabbrica - Il Cerreto  
La Fabbrica - Lascaux



**20x120**

8"x48"

La Fabbrica - Amazon  
La Fabbrica - Artile  
La Fabbrica - Ca' Foscari  
La Fabbrica - Castle  
La Fabbrica - High Line  
La Fabbrica - Il Cerreto  
La Fabbrica - Kauri  
La Fabbrica - Lascaux  
La Fabbrica - Marmi  
La Fabbrica - Yosemite



**80x80**

31 1/2"x31 1/2"

AVA - Aesthetica  
AVA - Absolute  
AVA - Azul Macauba  
AVA - Bardiglio Cenere  
AVA - Bronze Amani  
AVA - Calacatta  
AVA - Crema Marfil  
AVA - C-Stone  
AVA - District  
AVA - Lasa  
AVA - Metal  
AVA - Metro  
AVA - Nautilus  
AVA - Nero Belvedere  
AVA - Onice Serpentino  
AVA - Onice Smeraldo  
AVA - Pireni  
AVA - Portoro  
AVA - Scratch  
AVA - Skyline  
AVA - Statuario  
AVA - Statuario Splendente  
AVA - Taj Mahal  
AVA - Tortoise  
AVA - Travertino Classic  
AVA - White Macauba

La Fabbrica - Agglomerate  
La Fabbrica - Ardesia  
La Fabbrica - Blue Evolution  
La Fabbrica - Resine  
La Fabbrica - Space  
La Fabbrica - Storm



**40x80**

16"x31 1/2"

La Fabbrica - Resine

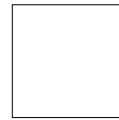

**60x60**

24"x24"

AVA - Absolute  
AVA - Azul Macauba  
AVA - Bardiglio Cenere  
AVA - Calacatta  
AVA - Lasa  
AVA - Nero Belvedere  
AVA - Skyline  
AVA - Statuario  
AVA - Statuario Splendente  
AVA - White Macauba

La Fabbrica - Agglomerate  
La Fabbrica - Ardesia  
La Fabbrica - Artile  
La Fabbrica - Blue Evolution  
La Fabbrica - Dolomiti  
La Fabbrica - Fusion  
La Fabbrica - High Line  
La Fabbrica - Imperial  
La Fabbrica - I Quarzi  
La Fabbrica - Jungle Stone  
La Fabbrica - Lascaux  
La Fabbrica - Pierres des Chateaux  
La Fabbrica - Pietra Lavica  
La Fabbrica - Ra-ku  
La Fabbrica - Resine  
La Fabbrica - Royal Stone  
La Fabbrica - Space  
La Fabbrica - Steelistic  
La Fabbrica - Storm



**6,1x37**

3"x12"

La Fabbrica - Artile  
La Fabbrica - Brush



**7,5x40,7**

3"x16"

La Fabbrica - Amazon  
La Fabbrica - Ca' Foscari  
La Fabbrica - Kauri



**7,5x45**

3"x18"

La Fabbrica - Amazon  
La Fabbrica - Ca' Foscari  
La Fabbrica - Kauri



**60,9x60,9**

24"x24"

La Fabbrica - Cotto del Casale



**40,6x60,9**

16"x24"

La Fabbrica - Borghi Italiani  
La Fabbrica - Cotto del Casale



**40,6x40,6**

16"x16"

La Fabbrica - Borghi Italiani  
La Fabbrica - Cotto del Casale



**20,3x40,6**

8"x16"

La Fabbrica - Borghi Italiani  
La Fabbrica - Cotto del Casale



**20,3x20,3**

8"x8"

La Fabbrica - Borghi Italiani  
La Fabbrica - Cotto del Casale



**20x20**

8"x8"

La Fabbrica - Blue Evolution  
La Fabbrica - Space



**30x60**

12"x24"

La Fabbrica - Agglomerate  
La Fabbrica - Ardesia  
La Fabbrica - Artile  
La Fabbrica - Blue Evolution  
La Fabbrica - Chromatic  
La Fabbrica - Dolomiti  
La Fabbrica - High Line  
La Fabbrica - Imperial  
La Fabbrica - I Quarzi  
La Fabbrica - Jungle Stone  
La Fabbrica - Lascaux  
La Fabbrica - Pierres des Chateaux  
La Fabbrica - Pietra Lavica  
La Fabbrica - Resine  
La Fabbrica - Royal Stone  
La Fabbrica - Space  
La Fabbrica - Steelistic  
La Fabbrica - Storm



**30,5x60,5**

12"x24"

La Fabbrica - Ardesia  
La Fabbrica - Dolomiti  
La Fabbrica - I Quarzi  
La Fabbrica - Royal Stone  
La Fabbrica - Storm



**30x30**

12"x12"

La Fabbrica - I Quarzi



**10x30**

4"x12"

La Fabbrica - High Line  
La Fabbrica - Imperial  
La Fabbrica - Jungle Stone  
La Fabbrica - Pierres des Chateaux



**7,5x30**

3"x12"

La Fabbrica - Chromatic

## OUTDOOR RII-C

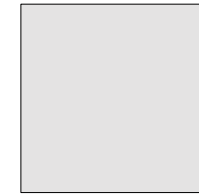

**100x100**

40"x40"

AVA - Skyline

La Fabbrica - Pietre d'Europa  
La Fabbrica - Pierres des Chateaux



**80x80**

31 1/2"x31 1/2"

La Fabbrica - Ardesia  
La Fabbrica - Space



**20x120**

8"x48"

La Fabbrica - Ca' Foscari



**120x60**

48"x24"

La Fabbrica - Ardesia  
La Fabbrica - Dolomiti



**60x60**

24"x24"

La Fabbrica - Dolomiti



**30x60**

12"x24"

La Fabbrica - Dolomiti  
La Fabbrica - I Quarzi



**30,5x60,5**

12"x24"

La Fabbrica - High Line  
La Fabbrica - Storm



**30x30**

12"x12"

La Fabbrica - I Quarzi



**60,9x60,9**

24"x24"

La Fabbrica - Cotto del Casale



**40,6x60,9**

16"x24"

La Fabbrica - Borghi Italiani  
La Fabbrica - Cotto del Casale



**40,6x40,6**

16"x16"

La Fabbrica - Borghi Italiani  
La Fabbrica - Cotto del Casale



**20,3x40,6**

8"x16"

La Fabbrica - Borghi Italiani  
La Fabbrica - Cotto del Casale



**20,3x20,3**

8"x8"

La Fabbrica - Borghi Italiani  
La Fabbrica - Cotto del Casale

## OUTDOOR 20 mm . RII-C



**100x100**

40"x40"

AVA - Skyline

La Fabbrica - Pietre d'Europa



**80x80**

31 1/2"x31 1/2"

La Fabbrica - Agglomerate  
La Fabbrica - Ardesia  
La Fabbrica - Blue Evolution  
La Fabbrica - Space  
La Fabbrica - Storm



**60x60**

24"x24"

La Fabbrica - Blue Evolution  
La Fabbrica - I Quarzi  
La Fabbrica - Royal Stone  
La Fabbrica - Storm



**60x100**

24"x40"

La Fabbrica - Pierres des Chateaux

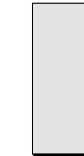

**40x80**

16"x31 1/2"

La Fabbrica - Ca' Foscari

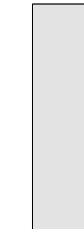

**40x120**

16"x48"

La Fabbrica - Amazon  
La Fabbrica - Ardesia  
La Fabbrica - Ca' Foscari  
La Fabbrica - Dolomiti  
La Fabbrica - Il Cerreto



Civilization of Beauty

#### INDOOR

AMAZON.....	26
CA' FOSCARI.....	40
IL CERRETO.....	54
KAURI.....	70
YOSEMITE.....	78

#### OUTDOOR RII-C

CA' FOSCARI.....	40
------------------	----

#### OUTDOOR 20 mm . RII-C

AMAZON.....	26
CA' FOSCARI.....	40
IL CERRETO.....	54

# LEGNO

Wood . Bois . Hölzer . Maderas . Дерево .



Floor: Surma 20x120 (8"x48") Nat. Ret.

# AMAZON

GRES PORCELLANATO COLORATO IN MASSA . COLORED BODY PORCELAIN STONEWARE  
GRES CÉRAMÉ COLORÉ DANS LA MASSE . EINGEFÄRBTES FEINSTEINZEUG  
GRES PORCELÁNICO COLOREADO EN MASA . КЕРАМОГРАНИТ ОКРАШЕННЫЙ В МАССЕ  
ISO 13006 - G - B1a (E ≤ 0,5%) - UNI EN 14411 - G

100% DESIGN  
AND PRODUCTION  
OF ITALY

V2  
SHADE SPECTRUM  
MODERATE

## INDOOR

R10-B



20x120 . 8"x48"  
Nat. Ret.

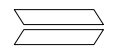

Chevron 7,5x40,7 . 3"x16"  
Nat.

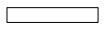

Listello 7,5x45 . 3"x18"  
Nat.

10 mm

## OUTDOOR

R11-C

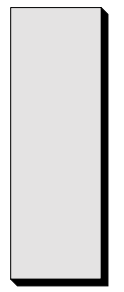

40x120 . 16"x48"  
Nat. Ret.

20 mm

SVILUPPO GRAFICO PER FORMATO Pattern by size Développement graphique par format Grafischer Entwurf für Format Desarrollo gráfico por formato Варианты графики для каждого формата	20x120 10 mm	7,5x40,7 10 mm	7,5x45 10 mm	40x120 20 mm
	42	11	11	14

# AMAZON

10 mm RI0-B



Floor  
Kamba 7,5x40,7 (3"x16") Chevron Nat.  
Kamba 7,5x45 (3"x18") Listello Nat.

## NAWA

INDOOR

10 mm R10-B



**076604**  
Listello  
7,5x45 . 3"x18"  
Nat.



**076035**  
20x120 . 8"x48"  
Nat. Ret.

**076608**  
Chevron  
7,5x40,7 . 3"x16"  
Nat.

## KAMBA

INDOOR

10 mm R10-B



**076602**  
Listello  
7,5x45 . 3"x18"  
Nat.



**076031**  
20x120 . 8"x48"  
Nat. Ret.

**076606**  
Chevron  
7,5x40,7 . 3"x16"  
Nat.

## ARARA

INDOOR

10 mm R10-B

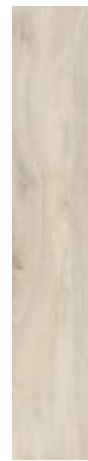

**076601**  
Listello  
7,5x45 . 3"x18"  
Nat.



**076029**  
20x120 . 8"x48"  
Nat. Ret.

**076605**  
Chevron  
7,5x40,7 . 3"x16"  
Nat.

## MATIS

INDOOR

10 mm R10-B



**076603**  
Listello  
7,5x45 . 3"x18"  
Nat.



**076033**  
20x120 . 8"x48"  
Nat. Ret.

**076607**  
Chevron  
7,5x40,7 . 3"x16"  
Nat.

## SURMA

INDOOR

10 mm R10-B



**076038**  
20x120 . 8"x48"  
Nat. Ret.

OUTDOOR

20 mm R11-C



**076021**  
40x120 . 16"x48"  
Nat. Ret.

OUTDOOR

20 mm R11-C



**076017**  
40x120 . 16"x48"  
Nat. Ret.

OUTDOOR

20 mm R11-C



**076015**  
40x120 . 16"x48"  
Nat. Ret.

OUTDOOR

20 mm R11-C



**076019**  
40x120 . 16"x48"  
Nat. Ret.













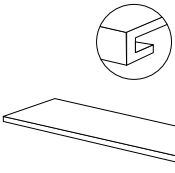
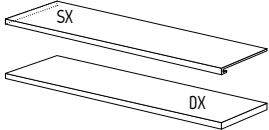



OUTDOOR

20 mm R11-C



**076024**  
40x120 . 16"x48"  
Nat. Ret.



						
	20x120 8"x48" Nat. Ret.	7,5x40,7 3"x16" Nat.	7,5x45 3"x18" Nat.	6,5x120 2 1/2"x48" Nat. Ret.	33x120x3,2h 13"x48"x1 1/4" Nat. Ret.	
NAWA 	076035	076608	076604	076106	076076	076096 SX 076086 DX
KAMBA 	076031	076606	076602	076102	076072	076092 SX 076082 DX
ARARA 	076029	076605	076601	076100	076070	076090 SX 076080 DX
MATIS 	076033	076607	076603	076104	076074	076094 SX 076084 DX
SURMA 	076038	-	-	076110	076077	076095 SX 076087 DX
PREZZO PRICE	€ 38,00 m <sup>2</sup>	€ 45,00 m <sup>2</sup>	€ 37,00 m <sup>2</sup>	€ 8,00 PZ/PCE	€ 140,00 PZ/PCE	€ 164,00 PZ/PCE
CODICE PREZZO PRICE CODE	M093	M107	M091	P029	P207	P231
	<b>Epal</b> 80x120	<b>Epal</b> 80x120	<b>Epal</b> 80x120	<b>Epal</b> 80x120	<b>Epal</b> 80x120	<b>Epal</b> 80x120
IMBALLO cm h. PACKING cm h.	75	75	75	-	-	-
 x 	4	13dx - 13sx	26	6	2	1
m <sup>2</sup> x 	0,96	0,82	0,90	-	-	-
Kg x 	21,10	17,71	19,40	11,04	23,00	12,00
 x 	48	42	42	-	-	-
m <sup>2</sup> x 	46,08	34,44	37,80	-	-	-
Kg x 	1.033	764	834	-	-	-

**\*\* A DISPOSIZIONE SOLO SU RICHIESTA. TEMPI DI CONSEGNA: 30GG.**  
Available upon request only. Delivery terms: 30 days.  
Disponible seulement sur requête. Délais de livraison: 30 jours.  
Verfügbar auf Anfrage. Lieferzeit: 30 Tage.  
Disponible sólo bajo pedido. Plazo de entrega: 30 días.  
Изготавливается только по специальной заявке. Срок поставки: 30 дней.

**TRA I FONDI DI SPESSORE 10 E 20 MM NON SI GARANTISCE L'ABBINABILITÀ.**  
We cannot guarantee tonal matches between the same background tiles with different thickness (10 or 20 mm).  
Les assortiments des tons ne sont pas garantis pour les fonds d'une épaisseur de 10 et 20 mm.  
Bei Bodenfliesen mit einer Stärke von 10 und 20 mm wird keine Einheitlichkeit der Farbtöne garantiert.  
Para los fondos de espesor 10 y 20 mm no se garantiza la combinabilidad de tonalidades.  
Для фоновой плитки толщиной 10 и 20 мм не гарантирована цветовая сочетаемость.

**PER IL GRADINO NON SI GARANTISCE LA STESSA TONALITÀ DEL FONDO.**  
We cannot guarantee that the shade of the stair tile will be the same as the background tile.  
Pour la marche, nous ne garantissons pas la même tonalité du fond.  
Für die Stufe wird nicht der gleiche Farbton der Grundfliese garantiert.  
Para el peldaño no se garantiza el mismo tono del fondo.  
Для ступени не гарантирована одинаковость тона с фоном.



Floor  
Surma 20x120 (8"x48") Nat. Ret.

# AMAZON

20 mm RII-C



Floor  
Kamba 40x120 (16"x48") Nat. RII 20 mm  
Kamba Gradone Bordo Svasato 40x120 (16"x48") Nat. RII 20 mm  
Kamba Griglia 20 - 20x60 (8"x24") Nat. RII 20 mm

	40x120 16"x48" Nat. Ret.	20x60 8"x24"	20x60 8"x24" Griglia 20 - Angolo SX / DX Drainage grid 20 - Corner SX / DX	40x120 16"x48" Gradone bordo grip Large step with anti-slip border	40x120 16"x48" Gradone bordo grip - Angolo SX / DX Large step with anti-slip border Corner SX / DX	40x120 16"x48" Gradone bordo 40 Large step 40	40x120 16"x48" Gradone bordo 40 SX / DX Large step 40 - Corner SX / DX	40x120 16"x48" Gradone bordo svasato Large step with rounded border	40x120 16"x48" Gradone bordo svasato - Angolo SX / DX Large step with rounded border - Corner SX / DX						
NAWA	076021	076437	076453 SX 076445 DX	076205	076197	076237 SX 076221 DX	076229 SX 076213 DX	076141	076133	076157 DX 076173 SX	076149 DX 076165 SX	076269	076261	076301 SX 076285 DX	076293 SX 076277 DX
KAMBA	076017	076435	076451 SX 076443 DX	076203	076195	076235 SX 076219 DX	076227 SX 076211 DX	076139	076131	076155 DX 076171 SX	076147 DX 076163 SX	076267	076259	076299 SX 076283 DX	076291 SX 076275 DX
ARARA	076015	076434	076450 SX 076442 DX	076202	076194	076234 SX 076218 DX	076226 SX 076210 DX	076138	076130	076154 DX 076170 SX	076146 DX 076162 SX	076266	076258	076298 SX 076282 DX	076290 SX 076274 DX
MATIS	076019	076436	076452 SX 076444 DX	076204	076196	076236 SX 076220 DX	076228 SX 076212 DX	076140	076132	076156 DX 076172 SX	076148 DX 076164 SX	076268	076260	076300 SX 076284 DX	076292 SX 076276 DX
SURMA	076024	076439	076457 SX 076447 DX	076207	076199	076239 SX 076223 DX	076231 SX 076215 DX	076143	076135	076159 DX 076175 SX	076151 DX 076167 SX	076271	076263	076303 SX 076287 DX	076295 SX 076279 DX
PREZZO PRICE	€ 64,00 m <sup>2</sup>	€ 138,00 PZ/PCE	€ 138,00 PZ/PCE	€ 160,00 PZ/PCE	€ 140,00 PZ/PCE	€ 178,00 PZ/PCE	€ 158,00 PZ/PCE	€ 136,00 PZ/PCE	€ 118,00 PZ/PCE	€ 154,00 PZ/PCE	€ 136,00 PZ/PCE	€ 288,00 PZ/PCE	€ 256,00 PZ/PCE	€ 308,00 PZ/PCE	€ 276,00 PZ/PCE
CODICE PREZZO PRICE CODE	M131	P205	P205	P227	P207	P245	P225	P203	P185	P221	P203	P311	P295	P321	P305
IMBALLO cm h. PACKING cm h.	Epal 80x120 75	Epal 80x120 -	Epal 80x120 -	Epal 80x120 -	Epal 80x120 -	Epal 80x120 -	Epal 80x120 -	Epal 80x120 -	Epal 80x120 -	Epal 80x120 -	Epal 80x120 -	Epal 80x120 -	Epal 80x120 -	Epal 80x120 -	Epal 80x120 -
	2	1	1	1	1	1	1	1	1	1	1	1	1	1	1
m <sup>2</sup> x	0,96	-	-	-	-	-	-	-	-	-	-	-	-	-	-
Kg x	43,01	6,00	6,00	22,50	22,50	22,50	22,50	22,50	22,50	22,50	22,50	22,50	22,50	22,50	22,50
x	24	-	-	-	-	-	-	-	-	-	-	-	-	-	-
m <sup>2</sup> x	23,04	-	-	-	-	-	-	-	-	-	-	-	-	-	-
Kg x	1.052	-	-	-	-	-	-	-	-	-	-	-	-	-	-



**Costa toro.**  
Bullnose edge.  
Bord boudin.  
Abgerundete Kante.  
Canto redondo.  
Закругленная кромка.



**Costa retta.**  
Straight edge.  
Bord droit.  
Gerade Kante.  
Canto recto.  
Прямоугольная кромка.

IL PESO DEI PEZZI SPECIALI 20 MM INDICATO IN TABELLA SI RIFERISCE AL PESO DEL SINGOLO PEZZO. PER CALCOLARE IL PESO COMPLESSIVO DEL MATERIALE IMBALLATO OCCORRERÀ AGGIUNGERE AL PESO IN TABELLA IL PESO DELL'IMBALLO E DELLA PALETTA (PESO VARIABILE DA 10 A 30 KG IN FUNZIONE DELLA QUANTITÀ E DELLA TIPOLOGIA DEI PEZZI SPECIALI RICHIESTI).

The weight of the 20 mm TRIMS stated in the table refers to the weight of each trim. - To calculate the total weight of the packed material, you will need to add the combined weight of the packing materials and the pallet (weight ranging from 10 to 30kg depending on the quantity and the type of the trims required) to the weight stated in the table.

Le poids des PIÈCES SPECIALES 20 mm indiqué dans le tableau se réfère au poids individuel de chaque pièce. Pour calculer le poids total du matériel emballé, il faudra ajouter au poids indiqué dans le tableau le poids de l'emballage et de la palette (poids variable de 10 à 30 kg en fonction de la quantité et du type de PIÈCES SPECIALES demandées).

Das in der Tabelle angegebene Gewicht der 20 mm-SONDERTEILE bezieht sich auf das Gewicht des Einzelteils. Zur Berechnung des Gesamtgewichts des verpackten Materials muss zum in der Tabelle aufgeführten Wert das Gewicht der Verpackung und der Palette (von 10 bis 30 kg variierbar in Abhängigkeit von der Menge und Art der gewünschten SONDERTEILE) dazugerechnet werden.

El peso de las PIEZAS ESPECIALES 20 mm indicado en la tabla se refiere al peso de cada pieza singularmente considerada. Para calcular el peso total del material embalado se deberá agregar al peso según la tabla, el peso del embalaje y del palet (peso variable entre 10 y 30 kg en función de la cantidad y tipo de las PIEZAS ESPECIALES requeridas).

Указанный в таблице вес СПЕЦИАЛЬНЫХ ИЗДЕЛИЙ 20 мм - это вес каждого отдельного изделия. Для расчета общего веса упакованного материала необходимо добавить к указанному в таблице значению вес упаковки и поддона (вес может составлять от 10 до 30 кг, в зависимости от количества и типа заказанных СПЕЦИАЛЬНЫХ ИЗДЕЛИЙ).

**ATTENZIONE:** Per particolari installazioni potrebbero essere necessari articoli ed accessori specifici non presenti in questo catalogo. Per queste esigenze prego riferirsi direttamente al referente commerciale La Fabbrica.







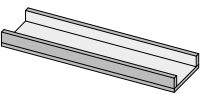
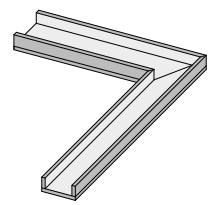
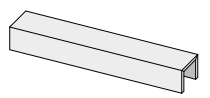
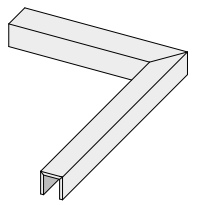

N.B. Particular items and accessories not listed in this catalogue may be required for certain laying methods. For these needs, please contact the La Fabbrica sales directly.

ATTENTION: Pour les installations particulières, certains articles et accessoires particuliers qui ne sont pas indiqués dans ce catalogue pourraient être nécessaires. Dans ces cas-là, nous vous prions de vous référer directement à la référence commerciale La Fabbrica.

ACHTUNG: Für besondere Installationen können besondere Artikel oder Sonderzubehör notwendig sein, die nicht im vorliegenden Katalog aufgeführt sind. Wenden Sie sich bitte in diesen Fällen direkt an den Vertrieb von La Fabbrica.

ATENCIÓN: para instalaciones particulares podrían requerirse artículos y accesorios específicos que no están presentes en este catálogo. Para tales casos rogamos contactar directamente al representante comercial de La Fabbrica.

ВНИМАНИЕ: Для особых применений могут быть необходимы специальные артикулы и аксессуары, не представленные в данном каталоге. По поводу этих вопросов просим вас обращаться непосредственно к менеджеру коммерческого отдела компании La Fabbrica.

	Canalina Channel	Canalina - Angolo SX / DX Channel - Corner SX / DX	Cordolo U-Border	Cordolo - Angolo SX / DX U-Border - Corner SX / DX
	 20x120x8h 8"x48"x3"h	 20x120x8h 8"x48"x3"h	 13x120x13h 5"x48"x5"h	 13x120x13h 5"x48"x5"h
NAWA	07634I	076357 SX 076349 DX	076365	07638I SX 076373 DX
KAMBA	076339	076355 SX 076347 DX	076363	076379 SX 07637I DX
ARARA	076338	076354 SX 076346 DX	076362	076378 SX 076370 DX
MATIS	076340	076356 SX 076348 DX	076364	076380 SX 076372 DX
SURMA	076343	076359 SX 07635I DX	076367	076383 SX 076375 DX
PREZZO PRICE	€ 188,00 PZ/PCE	€ 208,00 PZ/PCE	€ 248,00 PZ/PCE	€ 272,00 PZ/PCE
CODICE PREZZO PRICE CODE	P255	P27I	P29I	P303
	<b>Epal</b> 80x120	<b>Epal</b> 80x120	<b>Epal</b> 80x120	<b>Epal</b> 80x120
IMBALLO cm h. PACKING cm h.	-	-	-	-
 x 	1	1	1	1
m <sup>2</sup> x 	-	-	-	-
Kg x 	21,00	21,00	19,00	19,00
 x 	-	-	-	-
m <sup>2</sup> x 	-	-	-	-
Kg x 	-	-	-	-

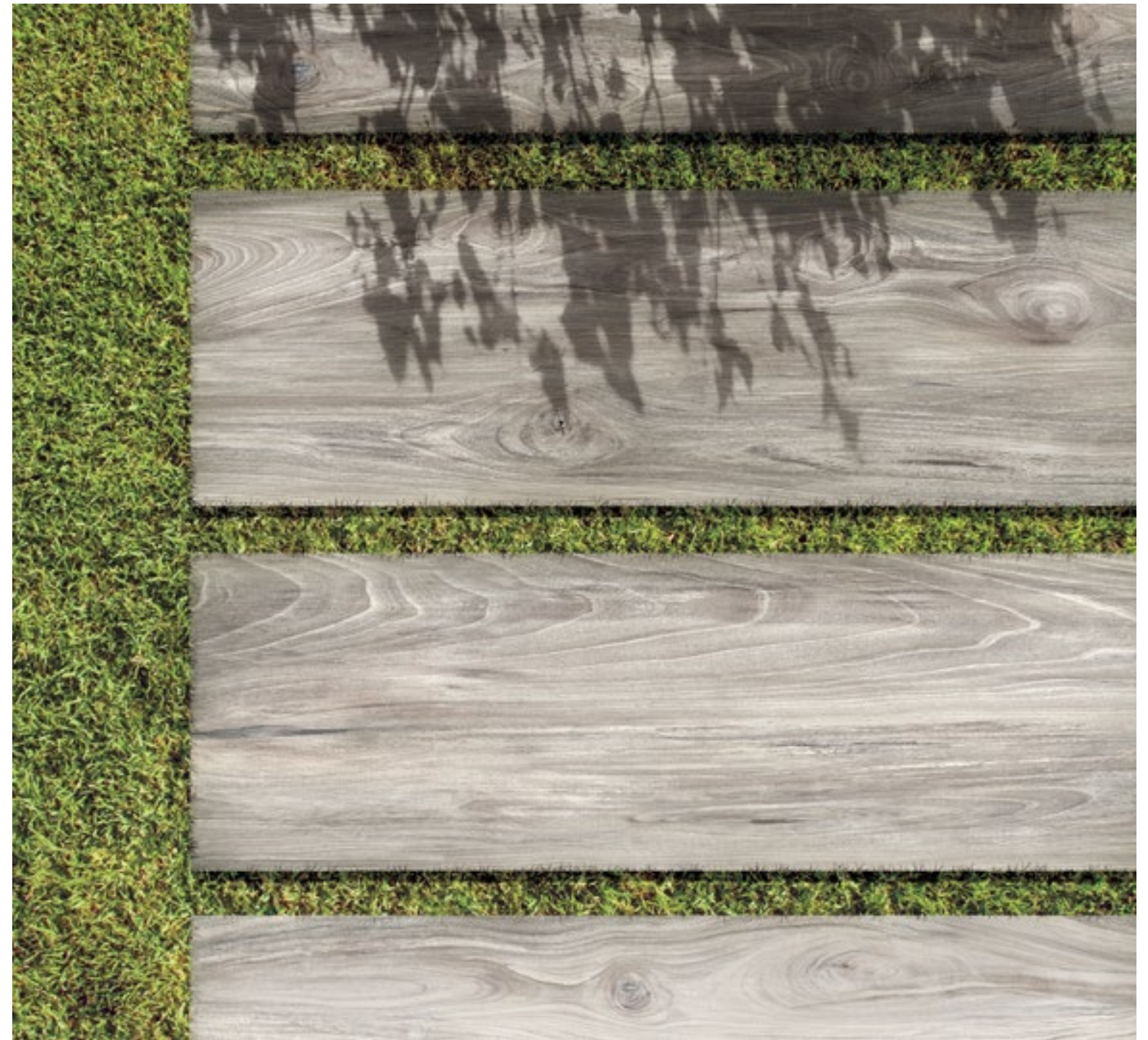

**Costa toro.**  
Bullnose edge.  
Bord boudin.  
Abgerundete Kante.  
Canto redondo.  
Закругленная кромка.



**Costa retta.**  
Straight edge.  
Bord droit.  
Gerade Kante.  
Canto recto.  
Прямоугольная кромка.

Floor  
Nawa 40x120 (16"x48") Nat. RII 20 mm

IL PESO DEI PEZZI SPECIALI 20 MM INDICATO IN TABELLA SI RIFERISCE AL PESO DEL SINGOLO PEZZO. PER CALCOLARE IL PESO COMPLESSIVO DEL MATERIALE IMBALLATO OCCORRERÀ AGGIUNGERE AL PESO IN TABELLA IL PESO DELL'IMBALLO E DELLA PALETTA (PESO VARIABILE DA 10 A 30 KG IN FUNZIONE DELLA QUANTITÀ E DELLA TIPOLOGIA DEI PEZZI SPECIALI RICHIESTI).

The weight of the 20 mm TRIMS stated in the table refers to the weight of each trim. - To calculate the total weight of the packed material, you will need to add the combined weight of the packing materials and the pallet (weight ranging from 10 to 30kg depending on the quantity and the type of the trims required) to the weight stated in the table.

Le poids des PIÈCES SPECIALES 20 mm indiqué dans le tableau se réfère au poids individuel de chaque pièce. Pour calculer le poids total du matériel emballé, il faudra ajouter au poids indiqué dans le tableau le poids de l'emballage et de la palette (poids variable de 10 à 30 kg en fonction de la quantité et du type de PIÈCES SPECIALES demandées).

Das in der Tabelle angegebene Gewicht der 20 mm-SONDERTEILE bezieht sich auf das Gewicht des Einzelteils. Zur Berechnung des Gesamtgewichts des verpackten Materials muss zum in der Tabelle aufgeführten Wert das Gewicht der Verpackung und der Palette (von 10 bis 30 kg variierbar in Abhängigkeit von der Menge und Art der gewünschten SONDERTEILE) dazugerechnet werden.

El peso de las PIEZAS ESPECIALES 20 mm indicado en la tabla se refiere al peso de cada pieza singularmente considerada. Para calcular el peso total del material embalado se deberá agregar al peso según la tabla, el peso del embalaje y del palet (peso variable entre 10 y 30 kg en función de la cantidad y tipo de las PIEZAS ESPECIALES requeridas).

Указанный в таблице вес СПЕЦИАЛЬНЫХ ИЗДЕЛИЙ 20 мм - это вес каждого отдельного изделия. Для расчета общего веса упакованного материала необходимо добавить к указанному в таблице значению вес упаковки и поддона (вес может составлять от 10 до 30 кг, в зависимости от количества и типа заказанных СПЕЦИАЛЬНЫХ ИЗДЕЛИЙ).

**ATTENZIONE:** Per particolari installazioni potrebbero essere necessari articoli ed accessori specifici non presenti in questo catalogo. Per queste esigenze prego riferirsi direttamente al referente commerciale La Fabbrica.

N.B. Particular items and accessories not listed in this catalogue may be required for certain laying methods. For these needs, please contact the La Fabbrica sales directly.

ATTENTION : Pour les installations particulières, certains articles et accessoires particuliers qui ne sont pas indiqués dans ce catalogue pourraient être nécessaires. Dans ces cas-là, nous vous prions de vous référer directement à la référence commerciale La Fabbrica.

ACHTUNG: Für besondere Installationen können besondere Artikel oder Sonderzubehör notwendig sein, die nicht im vorliegenden Katalog aufgeführt sind. Wenden Sie sich bitte in diesen Fällen direkt an den Vertrieb von La Fabbrica.

ATENCIÓN: para instalaciones particulares podrían requerirse artículos y accesorios específicos que no están presentes en este catálogo. Para tales casos rogamos contactar directamente al representante comercial de La Fabbrica.

ВНИМАНИЕ: Для особых применений могут быть необходимы специальные артикулы и аксессуары, не представленные в данном каталоге. По поводу этих вопросов просим вас обращаться непосредственно к менеджеру коммерческого отдела компании La Fabbrica.

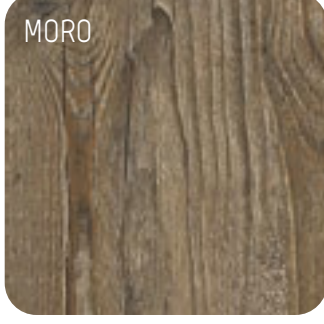

Floor: Avana 20x120 (6" x 48") Nat. Ret.

# CA' FOSCARI

GRES PORCELLANATO COLORATO IN MASSA . COLORED BODY PORCELAIN STONEWARE  
GRES CÉRAMÉ COLORÉ DANS LA MASSE . EINGEFÄRBTES FEINSTEINZEUG  
GRES PORCELÁNICO COLOREADO EN MASA . КЕРАМОГРАНИТ ОКРАШЕННЫЙ В МАССЕ  
ISO 13006 - G - B1a (E ≤ 0,5%) - UNI EN 14411 - G

100% DESIGN  
AND PRODUCTION  
OF ITALY

V2  
SHADE SPECTRUM  
MODERATE

## INDOOR

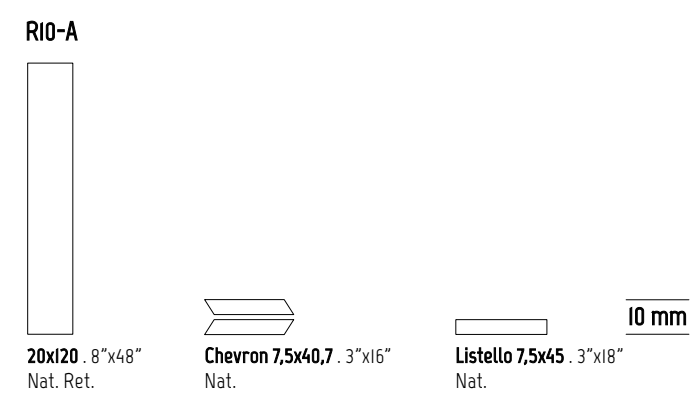

## OUTDOOR

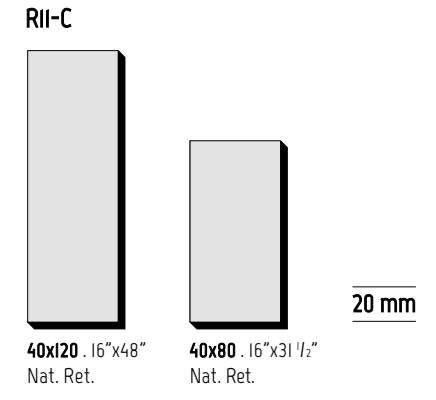
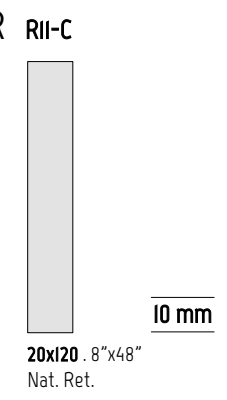

SVILUPPO GRAFICO PER FORMATO Pattern by size Développement graphique par format Grafischer Entwurf für Format Desarrollo gráfico por formato Варианты графики для каждого формата	20x120 10 mm 10 mm RII	7,5x40,7 10 mm	7,5x45 10 mm	40x120 20 mm	40x80 20 mm
	30	40	40	12	10

# CA' FOSCARI

10 mm RIO-A



Floor  
Tabacco Chevron 7,5x40,7 (3"x16") Nat.  
Tabacco Listello 7,5x45 (3"x18") Nat.

LINO

INDOOR

10 mm RIO-A

**094001**  
20x120 . 8"x48"  
Nat. Ret.

**094101**  
Listello  
7,5x45 . 3"x18"  
Nat.

**094105**  
Chevron  
7,5x40,7 . 3"x16"  
Nat.

CANAPA

INDOOR

10 mm RIO-A

**094005**  
20x120 . 8"x48"  
Nat. Ret.

**094102**  
Listello  
7,5x45 . 3"x18"  
Nat.

**094106**  
Chevron  
7,5x40,7 . 3"x16"  
Nat.

AVANA

INDOOR

10 mm RIO-A

**094009**  
20x120 . 8"x48"  
Nat. Ret.

**094103**  
Listello  
7,5x45 . 3"x18"  
Nat.

**094107**  
Chevron  
7,5x40,7 . 3"x16"  
Nat.

TABACCO

INDOOR

10 mm RIO-A

**094013**  
20x120 . 8"x48"  
Nat. Ret.

**094104**  
Listello  
7,5x45 . 3"x18"  
Nat.

**094108**  
Chevron  
7,5x40,7 . 3"x16"  
Nat.

MORO

INDOOR

10 mm RIO-A

**094017**  
20x120 . 8"x48"  
Nat. Ret.

OUTDOOR

10 mm RII-C

**094002**  
20x120 . 8"x48"  
Nat. Ret.

OUTDOOR

10 mm RII-C

**094006**  
20x120 . 8"x48"  
Nat. Ret.

OUTDOOR

10 mm RII-C

**094010**  
20x120 . 8"x48"  
Nat. Ret.

OUTDOOR

10 mm RII-C

**094014**  
20x120 . 8"x48"  
Nat. Ret.

OUTDOOR

10 mm RII-C

**094018**  
20x120 . 8"x48"  
Nat. Ret.

20 mm RII-C

**094031**  
40x120 . 16"x48"  
Nat. Ret.

**094041**  
40x80 . 16"x31 1/2"  
Nat. Ret.

20 mm RII-C

**094032**  
40x120 . 16"x48"  
Nat. Ret.

**094042**  
40x80 . 16"x31 1/2"  
Nat. Ret.

20 mm RII-C

**094033**  
40x120 . 16"x48"  
Nat. Ret.

**094043**  
40x80 . 16"x31 1/2"  
Nat. Ret.

20 mm RII-C

**094034**  
40x120 . 16"x48"  
Nat. Ret.

**094044**  
40x80 . 16"x31 1/2"  
Nat. Ret.















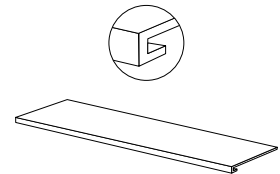
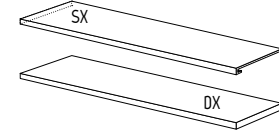



20 mm RII-C

**094035**  
40x120 . 16"x48"  
Nat. Ret.

**094045**  
40x80 . 16"x31 1/2"  
Nat. Ret.

# CA' FOSCARI

10 mm RIO-A

	 20x120 8"x48" Nat. Ret.	 7,5x40,7 3"x16" Nat.	 7,5x45 3"x18" Nat.	 6,5x120 2 1/2"x48" Nat. Ret.	 33x120x3,2h 13"x48"x1 1/4"h Nat. Ret.	 33x120x3,2h 13"x48"x1 1/4"h Nat. Ret.
LINO 	094001	094105	094101	094090	094060	094080 SX 094070 DX
CANAPA 	094005	094106	094102	094091	094061	094081 SX 094071 DX
AVANA 	094009	094107	094103	094092	094062	094082 SX 094072 DX
TABACCO 	094013	094108	094104	094093	094063	094083 SX 094073 DX
MORO 	094017	-	-	094094	094064	094084 SX 094074 DX
PREZZO PRICE	€ 38,00 m <sup>2</sup>	€ 45,00 m <sup>2</sup>	€ 37,00 m <sup>2</sup>	€ 8,00 PZ/PCE	€ 140,00 PZ/PCE	€ 164,00 PZ/PCE
CODICE PREZZO PRICE CODE	M093	M107	M091	P029	P207	P231
	<b>Epal</b> 80x120	<b>Epal</b> 80x120	<b>Epal</b> 80x120	<b>Epal</b> 80x120	<b>Epal</b> 80x120	<b>Epal</b> 80x120
IMBALLO cm h. PACKING cm h.	70	75	75	-	-	-
 x 	4	13dx - 13sx	26	6	2	1
m <sup>2</sup> x 	0,96	0,82	0,90	-	-	-
Kg x 	21,10	17,71	19,40	11,04	23,00	12,00
 x 	48	42	42	-	-	-
m <sup>2</sup> x 	46,08	34,44	37,80	-	-	-
Kg x 	1.033	764	834	-	-	-

\*\* A DISPOSIZIONE SOLO SU RICHIESTA. TEMPI DI CONSEGNA: 30GG.

Available upon request only. Delivery terms: 30 days.  
Disponible seulement sur requête. Délais de livraison: 30 jours.  
Verfügbar auf Anfrage. Lieferzeit: 30 Tage.  
Disponible sólo bajo pedido. Plazo de entrega: 30 días.  
Изготавливается только по специальной заявке. Срок поставки: 30 дней.

PER IL GRADINO NON SI GARANTISCE LA STESSA TONALITÀ DEL FONDO.

We cannot guarantee that the shade of the stair tile will be the same as the background tile.  
Pour la marche, nous ne garantissons pas la même tonalité du fond.  
Für die Stufe wird nicht der gleiche Farbton der Grundfliese garantiert.  
Para el peldaño no se garantiza el mismo tono del fondo.  
Для ступени не гарантирована одинаковость тона с фоном.

TRA I FONDI DI SPESSORE 10 E 20 MM NON SI GARANTISCE L'ABBINABILITÀ.

We cannot guarantee tonal matches between the same background tiles with different thickness (10 or 20 mm).  
Les assortiments des tons ne sont pas garantis pour les fonds d'une épaisseur de 10 et 20 mm.  
Bei Bodenfliesen mit einer Stärke von 10 und 20 mm wird keine Einheitlichkeit der Farbtöne garantiert.  
Para los fondos de espesor 10 y 20 mm no se garantiza la combinabilidad de tonalidades.  
Для фоновой плитки толщиной 10 и 20 мм не гарантирована цветовая сочетаемость.

10 mm RII-C

	 20x120 8"x48" Nat. Ret.
LINO 	094002
CANAPA 	094006
AVANA 	094010
TABACCO 	094014
MORO 	094018
PREZZO PRICE	€ 38,00 m <sup>2</sup>
CODICE PREZZO PRICE CODE	M093
	<b>Epal</b> 80x120
IMBALLO cm h. PACKING cm h.	70
 x 	4
m <sup>2</sup> x 	0,96
Kg x 	21,10
 x 	48
m <sup>2</sup> x 	46,08
Kg x 	1.033

ANSI A - 137.1: 2012  
WET DYNAMIC COEFFICIENT OF FRICTION | DCOF ≥ 0,42



INDOOR  
Floor  
Tabacco 20x120 (8"x48") Nat. Ret.

OUTDOOR  
Floor  
Tabacco 20x120 (8"x48") Nat. Ret. RII

ATTENZIONE: Per particolari installazioni potrebbero essere necessari articoli ed accessori specifici non presenti in questo catalogo. Per queste esigenze prego riferirsi direttamente al referente commerciale La Fabbrica.

N.B. Particular items and accessories not listed in this catalogue may be required for certain laying methods. For these needs, please contact the La Fabbrica sales directly.  
ATTENTION: Pour les installations particulières, certains articles et accessoires particuliers qui ne sont pas indiqués dans ce catalogue pourraient être nécessaires. Dans ces cas-là, nous vous prions de vous référer directement à la référence commerciale La Fabbrica.  
ACHTUNG: Für besondere Installationen können besondere Artikel oder Sonderzubehör notwendig sein, die nicht im vorliegenden Katalog aufgeführt sind. Wenden Sie sich bitte in diesen Fällen direkt an den Vertrieb von La Fabbrica.  
ATENCIÓN: para instalaciones particulares podrían requerirse artículos y accesorios específicos que no están presentes en este catálogo. Para tales casos rogamos contactar directamente al representante comercial de La Fabbrica.  
ВНИМАНИЕ: Для особых применений могут быть необходимы специальные артикулы и аксессуары, не представленные в данном каталоге. По поводу этих вопросов просим вас обращаться непосредственно к менеджеру коммерческого отдела компании La Fabbrica.



# CA' FOSCARI

20 mm RII-C



Floor  
Moro 40x120 (16"x48") Nat. RII 20mm

# CA' FOSCARI

20 mm RII-C

ANSI A - 137.1: 2012  
WET DYNAMIC COEFFICIENT OF FRICTION | DCOF ≥ 0,42

	Griglia 20 Drainage grid 20		Griglia 20 - Angolo SX / DX Drainage grid 20 - Corner SX / DX		Gradone bordo grip Large step with anti-slip border				Gradone bordo grip - Angolo SX / DX Large step with anti-slip border Corner SX / DX				Gradone bordo 40 Large step 40				Gradone bordo 40 SX / DX Large step 40 - Corner SX / DX					
	40x120 16"x48" Nat. Ret.	40x80 16"x31 1/2" Nat. Ret.	20x80 8"x31 1/2"	20x60 8"x24"	20x80 8"x31 1/2"	20x60 8"x24"	40x120 16"x48"	40x80 16"x31 1/2"	40x120 16"x48"	40x80 16"x31 1/2"	40x120 16"x48"	40x80 16"x31 1/2"	40x120 16"x48"	40x80 16"x31 1/2"	40x120 16"x48"	40x80 16"x31 1/2"						
	C	E	C	E	C	E	C	E	C	E	C	E	C	E	C	E						
LINO	094031	094041	094556	094256	094570 SX 094563 DX	094270 SX 094263 DX	094369	094362	094669	094662	094397 SX 094383 DX	094390 SX 094376 DX	094697SX 094683 DX	094690 SX 094676 DX	094327	094320	094627	094620	094355 SX 094341 DX	094348 SX 094334 DX	094655 SX 094641 DX	094648 SX 094634 DX
CANAPA	094032	094042	094557	094257	094571 SX 094564 DX	094271 SX 094264 DX	094370	094363	094670	094663	094398 SX 094384 DX	094391 SX 094377 DX	094698 SX 094684 DX	094691 SX 094677 DX	094328	094321	094628	094621	094356 SX 094342 DX	094349 SX 094335 DX	094656 SX 094642 DX	094649 SX 094635 DX
AVANA	094033	094043	094558	094258	094572 SX 094565 DX	094272 SX 094265 DX	094371	094364	094671	094664	094399 SX 094385 DX	094392 SX 094378 DX	094699 SX 094685 DX	094692 SX 094678 DX	094329	094322	094629	094622	094357 SX 094343 DX	094350 SX 094336 DX	094657 SX 094643 DX	094650 SX 094636 DX
TABACCO	094034	094044	094559	094259	094573 SX 094566 DX	094273 SX 094266 DX	094372	094365	094672	094665	094400 SX 094386 DX	094393 SX 094379 DX	094700 SX 094686 DX	094693 SX 094679 DX	094330	094323	094630	094623	094358 SX 094344 DX	094351 SX 094337 DX	094658 SX 094644 DX	094651 SX 094637 DX
MORO	094035	094045	094560	094260	094574 SX 094567 DX	094274 SX 094267 DX	094373	094366	094673	094666	094401 SX 094387 DX	094394 SX 094380 DX	094701 SX 094687 DX	094694 SX 094680 DX	094331	094324	094631	094624	094359 SX 094345 DX	094352 SX 094338 DX	094659 SX 094645 DX	094652 SX 094638 DX
PREZZO PRICE	€ 64,00 m <sup>2</sup>	€ 54,00 m <sup>2</sup>	€ 172,00 PZ/PCE	€ 138,00 PZ/PCE	€ 172,00 PZ/PCE	€ 138,00 PZ/PCE	€ 160,00 PZ/PCE	€ 140,00 PZ/PCE	€ 104,00 PZ/PCE	€ 92,00 PZ/PCE	€ 178,00 PZ/PCE	€ 158,00 PZ/PCE	€ 122,00 PZ/PCE	€ 110,00 PZ/PCE	€ 136,00 PZ/PCE	€ 116,00 PZ/PCE	€ 94,00 PZ/PCE	€ 76,00 PZ/PCE	€ 154,00 PZ/PCE	€ 136,00 PZ/PCE	€ 106,00 PZ/PCE	€ 94,00 PZ/PCE
CODICE PREZZO PRICE CODE	M131	M121	P239	P205	P239	P205	P227	P207	P171	P159	P245	P225	P189	P177	P203	P183	P161	P143	P221	P203	P173	P161
IMBALLO cm h. PACKING cm h.	Epal 80x120 75	Epal 80x120 95	Epal 80x120 -	Epal 80x120 -	Epal 80x120 -	Epal 80x120 -	Epal 80x120 -	Epal 80x120 -	Epal 80x120 -	Epal 80x120 -	Epal 80x120 -	Epal 80x120 -	Epal 80x120 -	Epal 80x120 -	Epal 80x120 -	Epal 80x120 -	Epal 80x120 -	Epal 80x120 -	Epal 80x120 -	Epal 80x120 -	Epal 80x120 -	
	2	2	1	1	1	1	1	1	1	1	1	1	1	1	1	1	1	1	1	1	1	1
m <sup>2</sup> x	0,96	0,64	-	-	-	-	-	-	-	-	-	-	-	-	-	-	-	-	-	-	-	-
Kg x	43,01	28,70	8,00	6,00	7,50	5,50	22,50	14,00	14,00	22,50	14,00	14,00	22,50	14,00	14,00	22,50	14,00	22,50	14,00	22,50	14,00	
	24	48	-	-	-	-	-	-	-	-	-	-	-	-	-	-	-	-	-	-	-	-
m <sup>2</sup> x	23,04	30,72	-	-	-	-	-	-	-	-	-	-	-	-	-	-	-	-	-	-	-	-
Kg x	1.052	1.398	-	-	-	-	-	-	-	-	-	-	-	-	-	-	-	-	-	-	-	-



**Costa toro.**  
Bullnose edge.  
Bord boudin.  
Abgerundete Kante.  
Canto redondo.  
Закругленная кромка.



**Costa retta.**  
Straight edge.  
Bord droit.  
Gerade Kante.  
Canto recto.  
Прямоугольная кромка.

IL PESO DEI PEZZI SPECIALI 20 MM INDICATO IN TABELLA SI RIFERISCE AL PESO DEL SINGOLO PEZZO. PER CALCOLARE IL PESO COMPLESSIVO DEL MATERIALE IMBALLATO OCCORRERÀ AGGIUNGERE AL PESO IN TABELLA IL PESO DELL'IMBALLO E DELLA PALETTA (PESO VARIABILE DA 10 A 30 KG IN FUNZIONE DELLA QUANTITÀ E DELLA TIPOLOGIA DEI PEZZI SPECIALI RICHIESTI).

The weight of the 20 mm TRIMS stated in the table refers to the weight of each trim. - To calculate the total weight of the packed material, you will need to add the combined weight of the packing materials and the pallet (weight ranging from 10 to 30kg depending on the quantity and the type of the trims required) to the weight stated in the table.

Le poids des PIÈCES SPECIALES 20 mm indiqué dans le tableau se réfère au poids individuel de chaque pièce. Pour calculer le poids total du matériel emballé, il faudra ajouter au poids indiqué dans le tableau le poids de l'emballage et de la palette (poids variable de 10 à 30 kg en fonction de la quantité et du type de PIÈCES SPECIALES demandées).

Das in der Tabelle angegebene Gewicht der 20 mm-SONDERTEILE bezieht sich auf das Gewicht des Einzelteils. Zur Berechnung des Gesamtgewichts des verpackten Materials muss zum in der Tabelle aufgeführten Wert das Gewicht der Verpackung und der Palette (von 10 bis 30 kg variierbar in Abhängigkeit von der Menge und Art der gewünschten SONDERTEILE) dazugerechnet werden.

El peso de las PIEZAS ESPECIALES 20 mm indicado en la tabla se refiere al peso de cada pieza singularmente considerada. Para calcular el peso total del material embalado se deberá agregar al peso según la tabla, el peso del embalaje y del palet (peso variable entre 10 y 30 kg en función de la cantidad y tipo de las PIEZAS ESPECIALES requeridas).

Указанный в таблице вес СПЕЦИАЛЬНЫХ ИЗДЕЛИЙ 20 мм - это вес каждого отдельного изделия. Для расчета общего веса упакованного материала необходимо добавить к указанному в таблице значению вес упаковки и поддона (вес может составлять от 10 до 30 кг, в зависимости от количества и типа заказанных СПЕЦИАЛЬНЫХ ИЗДЕЛИЙ).

**ATTENZIONE:** Per particolari installazioni potrebbero essere necessari articoli ed accessori specifici non presenti in questo catalogo. Per queste esigenze prego riferirsi direttamente al referente commerciale La Fabbrica.

N.B. Particular items and accessories not listed in this catalogue may be required for certain laying methods. For these needs, please contact the La Fabbrica sales directly.

ATTENTION : Pour les installations particulières, certains articles et accessoires particuliers qui ne sont pas indiqués dans ce catalogue pourraient être nécessaires. Dans ces cas-là, nous vous prions de vous référer directement à la référence commerciale La Fabbrica.

ACHTUNG: Für besondere Installationen können besondere Artikel oder Sonderzubehör notwendig sein, die nicht im vorliegenden Katalog aufgeführt sind. Wenden Sie sich bitte in diesen Fällen direkt an den Vertrieb von La Fabbrica.

ATENCIÓN: para instalaciones particulares podrían requerirse artículos y accesorios específicos que no están presentes en este catálogo. Para tales casos rogamos contactar directamente al representante comercial de La Fabbrica.

ВНИМАНИЕ: Для особых применений могут быть необходимы специальные артикулы и аксессуары, не представленные в данном каталоге. По поводу этих вопросов просим вас обращаться непосредственно к менеджеру коммерческого отдела компании La Fabbrica.

# CA' FOSCARI

20 mm RII-C

ANSI A - 137.1: 2012  
WET DYNAMIC COEFFICIENT OF FRICTION | DCOF ≥ 0,42

	Gradone bordo svasato Large step with rounded border				Gradone bordo svasato - Angolo SX / DX Large step with rounded border - Corner SX / DX				Canalina Channel	Canalina - Angolo SX / DX Channel - Corner SX / DX		Cordolo U-Border	Cordolo - Angolo SX / DX U-Border - Corner SX / DX			
	40x120 16"x48"	40x80 16"x31 1/2"	40x120 16"x48"	40x80 16"x31 1/2"	40x120 16"x48"	40x80 16"x31 1/2"	40x120 16"x48"	40x80 16"x31 1/2"	20x120x8h 8"x48"x33"h	20x80x8h 8"x31 1/2"x33"h	20x120x8h 8"x48"x33"h	20x80x8h 8"x31 1/2"x33"h	13x120x13h 5"x48"x55"h	13x80x13h 5"x31 1/2"x55"h	13x120x13h 5"x48"x55"h	13x80x13h 5"x31 1/2"x55"h
	C	C	C	C	C	C	C	C								
LINO	094411	094404	094711	094704	094439 SX 094425 DX	094432 SX 094418 DX	094739 SX 094725 DX	094732 SX 094718 DX	094277	094577	094292 SX 094284 DX	094592 SX 094584 DX	094299	094599	094313 SX 094306 DX	094613 SX 094606 DX
CANAPA	094412	094405	094712	094705	094440 SX 094426 DX	094433 SX 094419 DX	094740 SX 094726 DX	094733 SX 094719 DX	094278	094578	094293 SX 094285 DX	094593 SX 094585 DX	094300	094600	094314 SX 094307 DX	094614 SX 094607 DX
AVANA	094413	094406	094713	094706	094441 SX 094427 DX	094434 SX 094420 DX	094741 SX 094727 DX	094734 SX 094720 DX	094279	094579	094294 SX 094286 DX	094594 SX 094586 DX	094301	094601	094315 SX 094308 DX	094615 SX 094608 DX
TABACCO	094414	094407	094714	094707	094442 SX 094428 DX	094435 SX 094421 DX	094742 SX 094728 DX	094735 SX 094721 DX	094280	094580	094295 SX 094287 DX	094595 SX 094587 DX	094302	094602	094316 SX 094309 DX	094616 SX 094609 DX
MORO	094415	094408	094715	094708	094443 SX 094429 DX	094436 SX 094422 DX	094743 SX 094729 DX	094736 SX 094722 DX	094281	094581	094296 SX 094288 DX	094596 SX 094588 DX	094303	094603	094317 SX 094310 DX	094617 SX 094610 DX
PREZZO PRICE	€ 288,00 PZ/PCE	€ 256,00 PZ/PCE	€ 190,00 PZ/PCE	€ 168,00 PZ/PCE	€ 308,00 PZ/PCE	€ 276,00 PZ/PCE	€ 208,00 PZ/PCE	€ 186,00 PZ/PCE	€ 188,00 PZ/PCE	€ 122,00 PZ/PCE	€ 208,00 PZ/PCE	€ 150,00 PZ/PCE	€ 248,00 PZ/PCE	€ 162,00 PZ/PCE	€ 272,00 PZ/PCE	€ 190,00 PZ/PCE
CODICE PREZZO PRICE CODE	P311	P295	P257	P235	P321	P305	P271	P253	P255	P189	P271	P217	P291	P229	P303	P257
	Epal 80x120	Epal 80x120	Epal 80x120	Epal 80x120	Epal 80x120	Epal 80x120	Epal 80x120	Epal 80x120	Epal 80x120	Epal 80x120	Epal 80x120	Epal 80x120	Epal 80x120	Epal 80x120	Epal 80x120	Epal 80x120
IMBALLO cm h. PACKING cm h.	-	-	-	-	-	-	-	-	-	-	-	-	-	-	-	-
	1	1	1	1	1	1	1	1	1	1	1	1	1	1	1	1
m <sup>2</sup> x	-	-	-	-	-	-	-	-	-	-	-	-	-	-	-	-
Kg x	22,50	14,00	22,50	14,00	21,00	12,00	21,00	13,00	18,00	12,00	19,00	13,00				
	-	-	-	-	-	-	-	-	-	-	-	-				
m <sup>2</sup> x	-	-	-	-	-	-	-	-	-	-	-	-				
Kg x	-	-	-	-	-	-	-	-	-	-	-	-				



**Costa toro.**  
Bullnose edge.  
Bord boudin.  
Abgerundete Kante.  
Canto redondo.  
Закругленная кромка.



**Costa retta.**  
Straight edge.  
Bord droit.  
Gerade Kante.  
Canto recto.  
Прямоугольная кромка.

IL PESO DEI PEZZI SPECIALI 20 MM INDICATO IN TABELLA SI RIFERISCE AL PESO DEL SINGOLO PEZZO. PER CALCOLARE IL PESO COMPLESSIVO DEL MATERIALE IMBALLATO OCCORRERÀ AGGIUNGERE AL PESO IN TABELLA IL PESO DELL'IMBALLO E DELLA PALETTA (PESO VARIABILE DA 10 A 30 KG IN FUNZIONE DELLA QUANTITÀ E DELLA TIPOLOGIA DEI PEZZI SPECIALI RICHIESTI).

The weight of the 20 mm TRIMS stated in the table refers to the weight of each trim. - To calculate the total weight of the packed material, you will need to add the combined weight of the packing materials and the pallet (weight ranging from 10 to 30kg depending on the quantity and the type of the trims required) to the weight stated in the table.

Le poids des PIÈCES SPECIALES 20 mm indiqué dans le tableau se réfère au poids individuel de chaque pièce. Pour calculer le poids total du matériel emballé, il faudra ajouter au poids indiqué dans le tableau le poids de l'emballage et de la palette (poids variable de 10 à 30 kg en fonction de la quantité et du type de PIÈCES SPECIALES demandées).

Das in der Tabelle angegebene Gewicht der 20 mm-SONDERTEILE bezieht sich auf das Gewicht des Einzelteils. Zur Berechnung des Gesamtgewichts des verpackten Materials muss zum in der Tabelle aufgeführten Wert das Gewicht der Verpackung und der Palette (von 10 bis 30 kg variierbar in Abhängigkeit von der Menge und Art der gewünschten SONDERTEILE) dazugerechnet werden.

El peso de las PIEZAS ESPECIALES 20 mm indicado en la tabla se refiere al peso de cada pieza singularmente considerada. Para calcular el peso total del material embalado se deberá agregar al peso según la tabla, el peso del embalaje y del palet (peso variable entre 10 y 30 kg en función de la cantidad y tipo de las PIEZAS ESPECIALES requeridas).

Указанный в таблице вес СПЕЦИАЛЬНЫХ ИЗДЕЛИЙ 20 мм - это вес каждого отдельного изделия. Для расчета общего веса упакованного материала необходимо добавить к указанному в таблице значению вес упаковки и поддона (вес может составлять от 10 до 30 кг, в зависимости от количества и типа заказанных СПЕЦИАЛЬНЫХ ИЗДЕЛИЙ).

**ATTENZIONE:** Per particolari installazioni potrebbero essere necessari articoli ed accessori specifici non presenti in questo catalogo. Per queste esigenze prego riferirsi direttamente al referente commerciale La Fabbrica.

N.B. Particular items and accessories not listed in this catalogue may be required for certain laying methods. For these needs, please contact the La Fabbrica sale sales directly.

ATTENTION : Pour les installations particulières, certains articles et accessoires particuliers qui ne sont pas indiqués dans ce catalogue pourraient être nécessaires. Dans ces cas-là, nous vous prions de vous référer directement à la référence commerciale La Fabbrica.

ACHTUNG: Für besondere Installationen können besondere Artikel oder Sonderzubehör notwendig sein, die nicht im vorliegenden Katalog aufgeführt sind. Wenden Sie sich bitte in diesen Fällen direkt an den Vertrieb von La Fabbrica.

ATENCIÓN: para instalaciones particulares podrían requerirse artículos y accesorios específicos que no están presentes en este catálogo. Para tales casos rogamos contactar directamente al representante comercial de La Fabbrica.

ВНИМАНИЕ: Для особых применений могут быть необходимы специальные артикулы и аксессуары, не представленные в данном каталоге. По поводу этих вопросов просим вас обращаться непосредственно к менеджеру коммерческого отдела компании La Fabbrica.

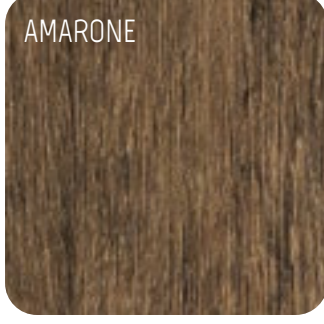
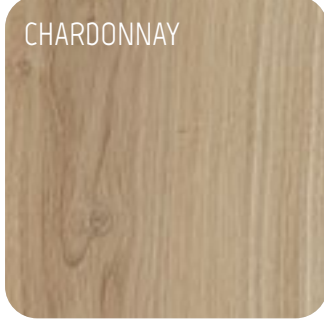

Floor: Amarone 20x120 (8"x48") Nat. Ret. - Chardonnay 20x120 (8"x48") Nat. Ret.

# IL CERRETO

GRES PORCELLANATO COLORATO IN MASSA . COLORED BODY PORCELAIN STONEWARE  
GRES CÉRAMÉ COLORÉ DANS LA MASSE . EINGEFÄRBTES FEINSTEINZEUG  
GRES PORCELÁNICO COLOREADO EN MASA . КЕРАМОГРАНИТ ОКРАШЕННЫЙ В МАССЕ  
ISO 13006 - G - B1a (E ≤ 0,5%) - UNI EN 14411 - G

100% DESIGN  
AND PRODUCTION  
OF ITALY

V2  
SHADE SPECTRUM  
MODERATE

## INDOOR

R10-B



23x149 . 9"x58 1/2"  
Nat. Ret.

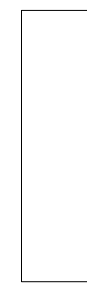

30x120 . 12"x48"  
Nat. Ret.

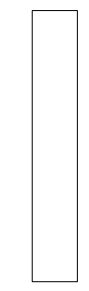

20x120 . 8"x48"  
Nat. Ret.

8,8 mm

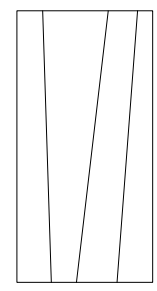

Decoro Chrome  
60x120 . 24"x48"  
Nat. Ret.



Decoro  
30x26 . 12"x10 1/4"  
Nat. Ret.

8,8 mm

— modular system —

## OUTDOOR

R11-C

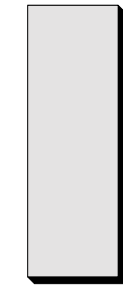

40x120 . 16"x48"  
Nat. Ret.

20 mm

SVILUPPO GRAFICO PER FORMATO  
Pattern by size  
Développement graphique par format  
Grafischer Entwurf für Format  
Desarrollo gráfico por formato  
Варианты графики для каждого формата

23x149  
8,8 mm

30x120  
8,8 mm

20x120  
8,8 mm

60x120 Decoro Chrome  
8,8 mm

40x120  
20 mm

21

14

21

4

12

# IL CERRETO

8,8 mm RIO-B



Floor  
Pinot Grigio 23x149 (9 1/2"x58 1/2") Nat. Ret.

# IL CERRETO

8,8 mm RIO-B



Floor  
Amarone 23x149 (9"x58 1/2")  
30x120 (12"x48") Nat. Ret.  
20x120 (8"x48") Nat. Ret.

Floor  
Soave 23x149 (9"x58 1/2") Nat. Ret.  
Soave 20x120 (8"x48") Nat. Ret.

# IL CERRETO

## PINOT GRIGIO

INDOOR

8,8 mm R10-B



**157005**  
23x149 . 9"x58 1/2"  
Nat. Ret.



**157013**  
30x120 . 12"x48"  
Nat. Ret.



**157023**  
20x120 . 8"x48"  
Nat. Ret.



**157090**  
Decoro Chrome  
60x120 . 24"x48"  
Nat. Ret.



**MOSCP01**  
Decoro Pinot Grigio White  
30x26 . 12"x10 1/4"  
Nat. Ret.

— modular system —

## OUTDOOR

20 mm R11-C



**157033**  
40x120 . 16"x48"  
Nat. Ret.

## CHAMPAGNE

INDOOR

8,8 mm R10-B



**157006**  
23x149 . 9"x58 1/2"  
Nat. Ret.



**157014**  
30x120 . 12"x48"  
Nat. Ret.



**157024**  
20x120 . 8"x48"  
Nat. Ret.



**157090**  
Decoro Chrome  
60x120 . 24"x48"  
Nat. Ret.



**MOSCP04**  
Decoro Champagne White  
30x26 . 12"x10 1/4"  
Nat. Ret.



**MOSCP05**  
Decoro Champagne Grey  
30x26 . 12"x10 1/4"  
Nat. Ret.



**MOSCP06**  
Decoro Champagne Black  
30x26 . 12"x10 1/4"  
Nat. Ret.

— modular system —

## OUTDOOR

20 mm R11-C



**157034**  
40x120 . 16"x48"  
Nat. Ret.

\* DECORO REALIZZATO SU FONDO PIERRES DES CHÂTEAUX  
Decoration on a pierres des châteaux background tile.  
Décor réalisé sur fond pierres des châteaux  
Auf Fliese Pierres des Châteaux ausgeführtes Dekor  
Decoración realizada sobre fondo pierres des châteaux  
Декор выполнен на фоновой плитке Pierres Des Châteaux

\* DECORO REALIZZATO SU FONDO PIERRES DES CHÂTEAUX  
Decoration on a pierres des châteaux background tile.  
Décor réalisé sur fond pierres des châteaux  
Auf Fliese Pierres des Châteaux ausgeführtes Dekor  
Decoración realizada sobre fondo pierres des châteaux  
Декор выполнен на фоновой плитке Pierres Des Châteaux

# IL CERRETO

## SOAVE

INDOOR

8,8 mm R10-B



**157004**  
23x149 . 9"x58 1/2"  
Nat. Ret.



**157012**  
30x120 . 12"x48"  
Nat. Ret.



**157022**  
20x120 . 8"x48"  
Nat. Ret.



**157090**  
Decoro Chrome  
60x120 . 24"x48"  
Nat. Ret.

— modular system —

## CHARDONNAY

INDOOR

8,8 mm R10-B



**157002**  
23x149 . 9"x58 1/2"  
Nat. Ret.



**157010**  
30x120 . 12"x48"  
Nat. Ret.



**157020**  
20x120 . 8"x48"  
Nat. Ret.

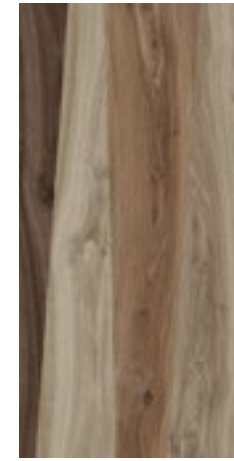

**157090**  
Decoro Chrome  
60x120 . 24"x48"  
Nat. Ret.



**MOSCP02**  
Decoro Chardonnay Beige  
30x26 . 12"x10 1/4"  
Nat. Ret.

— modular system —

## OUTDOOR



**157030**  
40x120 . 16"x48"  
Nat. Ret.

20 mm R11-C

\* DECORO REALIZZATO SU FONDO PIERRES DES CHÂTEAUX  
Decoration on a pierres des châteaux background tile.  
Décor réalisé sur fond pierres des châteaux  
Auf Fliese Pierres des Châteaux ausgeführtes Dekor  
Decoración realizada sobre fondo pierres des châteaux  
Декор выполнен на фоновой плитке Pierres Des Châteaux



# IL CERRETO

## AMARONE

INDOOR

8,8 mm R10-B



**157003**  
23x149 . 9"x58 1/2"  
Nat. Ret.



**157011**  
30x120 . 12"x48"  
Nat. Ret.



**157021**  
20x120 . 8"x48"  
Nat. Ret.



**157090**  
Decoro Chrome  
60x120 . 24"x48"  
Nat. Ret.



**MOSCP03**  
Decoro Amarone Brown  
30x26 . 12"x10 1/4"  
Nat. Ret.

— modular system —

OUTDOOR

20 mm R11-C



**157031**  
40x120 . 16"x48"  
Nat. Ret.

\* DECORO REALIZZATO SU FONDO PIERRES DES CHÂTEAUX  
Décoration on a pierres des châteaux background tile.  
Décor réalisé sur fond pierres des châteaux  
Auf Fliese Pierres des Châteaux ausgeführtes Dekor  
Decoración realizada sobre fondo pierres des châteaux  
Декор выполнен на фоновой плитке Pierres Des Châteaux



Floor  
Champagne 23x149 (9"x58 1/2") Nat. Ret.

Bathtub  
Devon&Devon Dove

# IL CERRETO

8,8 mm RIO-B

ANSI A - 137.1: 2012  
WET DYNAMIC COEFFICIENT OF FRICTION | DCOF ≥ 0,42

	modular system							
	23x149 9"x58 1/2" Nat. Ret.	30x120 12"x48 Nat. Ret.	20x120 8"x48" Nat. Ret.	Decoro Chrome Chrome decorative tile 60x120 24"x48 Nat. Ret.	Decoro Decorative tile 30x26 12"x10 1/4" Nat. Ret.	Battiscopa Skirting 6,5x120 2 1/2"x48" Nat. Ret.	Gradino costa retta Straight-edge step ** 33x120x3,2h 13"x48"x1 1/4"h Nat. Ret.	Gradino costa retta - Angolo SX / DX Straight-edge step - LH/RH corner ** 33x120x3,2h 13"x48"x1 1/4"h Nat. Ret.
PINOT GRIGIO	157005	157013	157023	157090	MOSCP01	157104	157204	157224 SX 157214 DX
CHAMPAGNE	157006	157014	157024	157090	MOSCP04 MOSCP05 MOSCP06	157101	157201	157221 SX 157211 DX
SOAVE	157004	157012	157022	157090	-	157102	157202	157222 SX 157212 DX
CHARDONNAY	157002	157010	157020	157090	MOSCP02	157103	157203	157223 SX 157213 DX
AMARONE	157003	157011	157021	157090	MOSCP03	157105	157205	157225 SX 157215 DX
PREZZO PRICE	€ 44,00 m <sup>2</sup>	€ 38,00 m <sup>2</sup>	€ 38,00 m <sup>2</sup>	€ 40,00 m <sup>2</sup>	€ 240,00 m <sup>2</sup>	€ 8,00 PZ/PC	€ 140,00 PZ/PC	€ 164,00 PZ/PC
CODICE PREZZO PRICE CODE	M105	M093	M093	M097	M287	P029	P207	P231
	Pallet 77x152	Epal 80x120	Epal 80x120	Epal 80x120	Epal 80x120	Epal 80x120	Epal 80x120	Epal 80x120
IMBALLO cm h. PACKING cm h.	55	75	75	75	75	-	-	-
x	3	3	4	2	6	6	2	1
m <sup>2</sup> x	1,03	1,08	0,96	1,44	0,47	-	-	-
Kg x	21,31	22,50	20,32	29,90	10,74	9,94	20,7	10,8
x	36	40	48	32	60	-	-	-
m <sup>2</sup> x	37,08	43,2	46,08	46,08	28,2	-	-	-
Kg x	807,16	920	995,36	976,8	664,4	-	-	-



Wall  
Decoro Champagne Grey ( Il Cerreto Champagne Pierres des Châteaux Cheverny ) 30x26 (12"x10 1/4") Nat. Ret.

Floor  
Champagne 20x120 (8"x48") Nat. Ret.  
Champagne 30x120 (12"x48") Nat. Ret.

\*\* A DISPOSIZIONE SOLO SU RICHIESTA. TEMPI DI CONSEGNA: 30GG.  
Available upon request only. Delivery terms: 30 days.  
Disponible seulement sur requête. Délais de livraison: 30 jours.  
Verfügbar auf Anfrage. Lieferzeit: 30 Tage.  
Disponibile sólo bajo pedido. Plazo de entrega: 30 días.  
Изготавливается только по специальной заявке. Срок поставки: 30 дней.











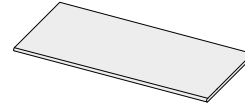



PER IL GRADINO NON SI GARANTISCE LA STESSA TONALITÀ DEL FONDO.  
We cannot guarantee that the shade of the stair tile will be the same as the background tile.  
Pour la marche, nous ne garantissons pas la même tonalité du fond.  
Für die Stufe wird nicht der gleiche Farbton der Grundfliese garantiert.  
Para el peldaño no se garantiza el mismo tono del fondo.  
Для ступени не гарантирована одинаковость тона с фоном.

TRA I FONDI DI SPESSORE 8,8 E 20 MM NON SI GARANTISCE L'ABBINABILITÀ.  
We cannot guarantee tonal matches between the same background tiles with different thickness (8,8 or 20 mm).  
Les assortiments des tons ne sont pas garantis pour les fonds d'une épaisseur de 8,8 et 20 mm.  
Bei Bodenfliesen mit einer Stärke von 8,8 und 20 mm wird keine Einheitlichkeit der Farbtöne garantiert.  
Para los fondos de espesor 8,8 y 20 mm no se garantiza la combinabilidad de tonalidades.  
Для фоновой плитки толщиной 8,8 и 20 мм не гарантирована цветовая сочетаемость.

# IL CERRETO

20 mm RII-C

ANSI A - I37.I: 2012  
WET DYNAMIC COEFFICIENT OF FRICTION | DCOF ≥ 0,42

		Gradone bordo 40 Large step 40
	40x120 16"x48" Nat. Ret.	 40x120 16"x48" C
PINOT GRIGIO 	157033	157404
CHAMPAGNE 	157034	157401
CHARDONNAY 	157030	157403
AMARONE 	157031	157405
PREZZO PRICE	€ 64,00 m <sup>2</sup>	€ 136,00 PZ/PCPE
CODICE PREZZO PRICE CODE	M131	P203
	<b>Epal</b> 80x120	<b>Epal</b> 80x120
IMBALLO cm h.  PACKING cm h.	75	-
 x 	2	1
m <sup>2</sup> x 	0,96	-
Kg x 	43,01	22,50
 x 	24	-
m <sup>2</sup> x 	23,04	-
Kg x 	1.052,24	-



Costa toro.  
Bullnose edge.  
Bord boudin.  
Abgerundete Kante.  
Canto redondo.  
Закругленная кромка.

IL PESO DEI PEZZI SPECIALI 20 MM INDICATO IN TABELLA SI RIFERISCE AL PESO DEL SINGOLO PEZZO. PER CALCOLARE IL PESO COMPLESSIVO DEL MATERIALE IMBALLATO OCCORRERÀ AGGIUNGERE AL PESO IN TABELLA IL PESO DELL'IMBALLO E DELLA PALETTA (PESO VARIABILE DA 10 A 30 KG IN FUNZIONE DELLA QUANTITÀ E DELLA TIPOLOGIA DEI PEZZI SPECIALI RICHIESTI).

The weight of the 20 mm TRIMS stated in the table refers to the weight of each trim. - To calculate the total weight of the packed material, you will need to add the combined weight of the packing materials and the pallet (weight ranging from 10 to 30kg depending on the quantity and the type of the trims required) to the weight stated in the table.

Le poids des PIÈCES SPECIALES 20 mm indiqué dans le tableau se réfère au poids individuel de chaque pièce. Pour calculer le poids total du matériel emballé, il faudra ajouter au poids indiqué dans le tableau le poids de l'emballage et de la palette (poids variable de 10 à 30 kg en fonction de la quantité et du type de PIÈCES SPECIALES demandées).

Das in der Tabelle angegebene Gewicht der 20 mm-SONDERTEILE bezieht sich auf das Gewicht des Einzelteils. Zur Berechnung des Gesamtgewichts des verpackten Materials muss zum in der Tabelle aufgeführten Wert das Gewicht der Verpackung und der Palette (von 10 bis 30 kg variierbar in Abhängigkeit von der Menge und Art der gewünschten SONDERTEILE) dazugerechnet werden.

El peso de las PIEZAS ESPECIALES 20 mm indicado en la tabla se refiere al peso de cada pieza singularmente considerada. Para calcular el peso total del material embalado se deberá agregar al peso según la tabla, el peso del embalaje y del palet (peso variable entre 10 y 30 kg en función de la cantidad y tipo de las PIEZAS ESPECIALES requeridas).

Указанный в таблице вес СПЕЦИАЛЬНЫХ ИЗДЕЛИЙ 20 мм - это вес каждого отдельного изделия. Для расчета общего веса упакованного материала необходимо добавить к указанному в таблице значению вес упаковки и поддона (вес может составлять от 10 до 30 кг, в зависимости от количества и типа заказанных СПЕЦИАЛЬНЫХ ИЗДЕЛИЙ).

Floor  
Chardonnay 40x120 (16"x48") Nat. Ret. RII 20mm

ATTENZIONE: Per particolari installazioni potrebbero essere necessari articoli ed accessori specifici non presenti in questo catalogo. Per queste esigenze prego riferirsi direttamente al referente commerciale La Fabbrica.

N.B. Particular items and accessories not listed in this catalogue may be required for certain laying methods. For these needs, please contact the La Fabbrica sales directly.

ATTENTION: Pour les installations particulières, certains articles et accessoires particuliers qui ne sont pas indiqués dans ce catalogue pourraient être nécessaires. Dans ces cas-là, nous vous prions de vous référer directement à la référence commerciale La Fabbrica.

ACHTUNG: Für besondere Installationen können besondere Artikel oder Sonderzubehör notwendig sein, die nicht im vorliegenden Katalog aufgeführt sind. Wenden Sie sich bitte in diesen Fällen direkt an den Vertrieb von La Fabbrica.

ATENCIÓN: para instalaciones particulares podrían requerirse artículos y accesorios específicos que no están presentes en este catálogo. Para tales casos rogamos contactar directamente al representante comercial de La Fabbrica.

ВНИМАНИЕ: Для особых применений могут быть необходимы специальные артикулы и аксессуары, не представленные в данном каталоге. По поводу этих вопросов просим вас обращаться непосредственно к менеджеру коммерческого отдела компании La Fabbrica.

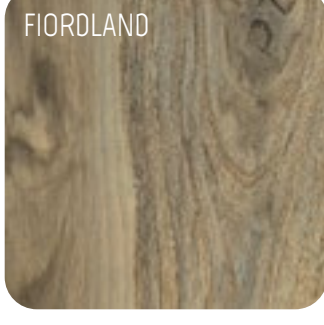
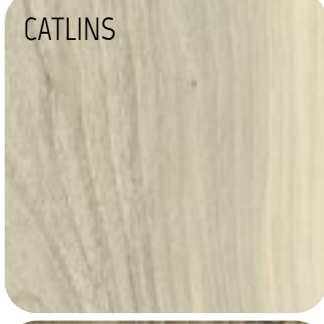
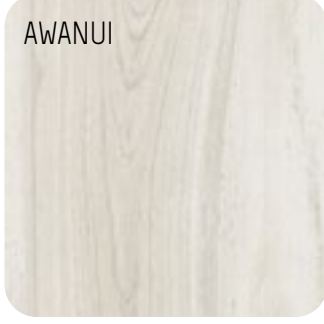

# KAURI

Wall: Catlins 20x120 (8"x48") Lap. Ret. / Floor: Fiordland 20x120 (8"x48") Lap. Ret.

GRES PORCELLANATO COLORATO IN MASSA . COLORED BODY PORCELAIN STONEWARE  
GRÈS CÉRAMÉ COLORÉ DANS LA MASSE . EINGEFÄRBTES FEINSTEINZEUG  
GRES PORCELÁNICO COLOREADO EN MASA . КЕРАМОГРАНИТ ОКРАШЕННЫЙ В МАССЕ  
ISO 13006 - G - B1a (E ≤ 0,5%) - UNI EN 14411 - G

100% DESIGN  
AND PRODUCTION  
OF ITALY

V3  
SHADE SPECTRUM  
MODERATE

## INDOOR

RI0-A (naturale)

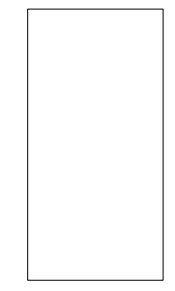

60x120 . 24"x48"  
Lap. Ret.



20x120 . 8"x48"  
Nat. Ret.  
20x120 . 8"x48"  
Lap. Ret.

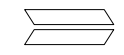

Chevron 7,5x40,7 . 3"x16"  
Nat.

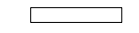

Listello 7,5x45 . 3"x18"  
Nat.



Decoro 20x20 . 8"x8"  
Lap. Ret.

10 mm

SVILUPPO GRAFICO PER FORMATO Pattern by size Développement graphique par format Grafischer Entwurf für Format Desarrollo gráfico por formato Варианты графики для каждого формата	60x120 10 mm	20x120 10 mm	7,5x40,7 10 mm	7,5x45 10 mm
	15	39	50	50

# KAURI

10 mm RIO-A (naturale)



Floor  
Nelson 20x120 (8"x48") Lap. Ret.  
Decoro Zeland 20x20 (8"x8") Lap. Ret.

Floor  
Awanui 20x120 (8"x48") Nat. Ret.



# KAURI

## VICTORIA

INDOOR



10 mm R10-A (naturale)

**075100**  
20x120 . 8"x48"  
Nat. Ret.  
**075101**  
20x120 . 8"x48"  
Lap. Ret.



**075309**  
Listello  
7,5x45 . 3"x18"  
Nat.



**075310**  
Chevron  
7,5x40,7 . 3"x16"  
Nat.



**075032**  
60x120 . 24"x48"  
Lap. Ret.

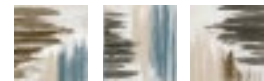

**075351**  
Decoro Zeland  
20x20 . 8"x8"  
Lap. Ret.

## TASMAN

INDOOR



10 mm R10-A (naturale)

**075095**  
20x120 . 8"x48"  
Nat. Ret.  
**075096**  
20x120 . 8"x48"  
Lap. Ret.



**075302**  
Listello  
7,5x45 . 3"x18"  
Nat.



**075304**  
Chevron  
7,5x40,7 . 3"x16"  
Nat.



**075027**  
60x120 . 24"x48"  
Lap. Ret.

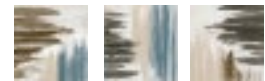

**075351**  
Decoro Zeland  
20x20 . 8"x8"  
Lap. Ret.

## NELSON

INDOOR



10 mm R10-A (naturale)

**075102**  
20x120 . 8"x48"  
Nat. Ret.  
**075104**  
20x120 . 8"x48"  
Lap. Ret.



**075311**  
Listello  
7,5x45 . 3"x18"  
Nat.



**075312**  
Chevron  
7,5x40,7 . 3"x16"  
Nat.



**075351**  
Decoro Zeland  
20x20 . 8"x8"  
Lap. Ret.

## AWANUI

INDOOR



10 mm R10-A (naturale)

**075071**  
20x120 . 8"x48"  
Nat. Ret.  
**075072**  
20x120 . 8"x48"  
Lap. Ret.



**075301**  
Listello  
7,5x45 . 3"x18"  
Nat.



**075303**  
Chevron  
7,5x40,7 . 3"x16"  
Nat.

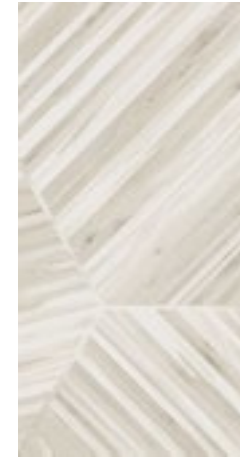

**075003**  
60x120 . 24"x48"  
Lap. Ret.

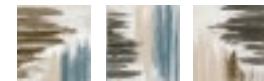

**075351**  
Decoro Zeland  
20x20 . 8"x8"  
Lap. Ret.

## CATLINS

INDOOR



10 mm R10-A (naturale)

**075075**  
20x120 . 8"x48"  
Nat. Ret.  
**075076**  
20x120 . 8"x48"  
Lap. Ret.



**075305** . Listello  
7,5x45 . 3"x18"  
Nat.



**075306**  
Chevron  
7,5x40,7 . 3"x16"  
Nat.

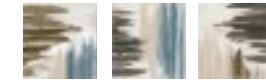

**075351**  
Decoro Zeland  
20x20 . 8"x8"  
Lap. Ret.

## FIORDLAND

INDOOR

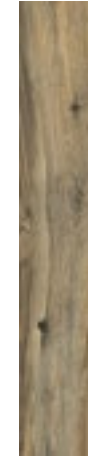

10 mm R10-A (naturale)

**075085**  
20x120 . 8"x48"  
Nat. Ret.  
**075086**  
20x120 . 8"x48"  
Lap. Ret.



**075307**  
Listello  
7,5x45 . 3"x18"  
Nat.



**075308**  
Chevron  
7,5x40,7 . 3"x16"  
Nat.

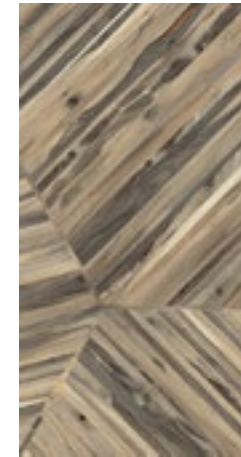

**075017**  
60x120 . 24"x48"  
Lap. Ret.

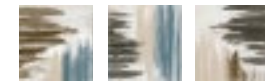

**075351**  
Decoro Zeland  
20x20 . 8"x8"  
Lap. Ret.









# KAURI

10 mm RIO-A (naturale)

Solo superficie naturale  
Only natural surface

ANSI A - 137.1: 2012  
WET DYNAMIC COEFFICIENT OF FRICTION

DCOF ≥ 0,42

	60x120 24"x48" Lap. Ret.	20x120 8"x48" Nat. Ret.	20x120 8"x48" Lap. Ret.	Chevron Chevron 7,5x40,7 3"x16" Nat.	Listello Strip 7,5x45 3"x18" Nat.	Zeland Zeland 20x20 8"x8" Lap. Ret.	Battiscopa Skirting 6,5x120 2 1/2"x48" Nat. Ret.	6,5x120 2 1/2"x48" Lap. Ret.	Gradino costa retta Straight-edge step ** 33x120x3,2h 13"x48"x1 1/4" Nat. Ret.	Gradino costa retta - Angolo SX / DX Straight-edge step - LH/RH corner ** 33x120x3,2h 13"x48"x1 1/4" Nat. Ret.
VICTORIA	075032	075100	075101	075310	075309	075351	075162	075163	075210	075212 SX 075214 DX
TASMAN	075027	075095	075096	075304	075302	075351	075160	075161	075204	075206 SX 075208 DX
NELSON	-	075102	075104	075312	075311	075351	075164	075166	075226	075227 SX 075228 DX
AWANUI	075003	075071	075072	075303	075301	075351	075150	075151	075180	075182 SX 075184 DX
CATLINS	-	075075	075076	075306	075305	075351	075152	075153	075186	075188 SX 075190 DX
FIORDLAND	075017	075085	075086	075308	075307	075351	075156	075157	075192	075194 SX 075196 DX
PREZZO PRICE	€ 68,00 m <sup>2</sup>	€ 48,00 m <sup>2</sup>	€ 62,00 m <sup>2</sup>	€ 45,00 m <sup>2</sup>	€ 37,00 m <sup>2</sup>	€ 74,00 PZ/PCE	€ 8,00 PZ/PCE	€ 9,00 PZ/PCE	€ 140,00 PZ/PCE	€ 164,00 PZ/PCE
CODICE PREZZO PRICE CODE	M135	M113	M129	M107	M091	P141	P029	P033	P207	P231
	Epal 80x120	Epal 80x120	Epal 80x120	Epal 80x120	Epal 80x120	Epal 80x120	Epal 80x120	Epal 80x120	Epal 80x120	Epal 80x120
IMBALLO cm h. PACKING cm h.	75	75	55	75	75	-	-	-	-	-
 x 	2	4	6	13dx - 13sx	26	3	6	2	2	1
m <sup>2</sup> x 	1,44	0,96	1,44	0,82	0,90	0,12	-	-	-	-
Kg x 	33,41	20,75	32,68	17,71	19,44	2,90	11,00	23,00	23,00	12,00
 x 	30	48	24	42	42	-	-	-	-	-
m <sup>2</sup> x 	43,20	46,08	34,56	34,44	37,80	-	-	-	-	-
Kg x 	1.022	1.016	805	764	836	-	-	-	-	-



Floor  
Tasman Chevron 7,5x40,7 (3"x16") Nat.

\*\* A DISPOSIZIONE SOLO SU RICHIESTA. TEMPI DI CONSEGNA: 30GG.  
Available upon request only. Delivery terms: 30 days.  
Disponible seulement sur requête. Délais de livraison: 30 jours.  
Verfügbar auf Anfrage. Lieferzeit: 30 Tage.  
Disponibile sólo bajo pedido. Plazo de entrega: 30 días.  
Изготавливается только по специальной заявке. Срок поставки: 30 дней.

PER IL GRADINO NON SI GARANTISCE LA STESSA TONALITÀ DEL FONDO.  
We cannot guarantee that the shade of the stair tile will be the same as the background tile.  
Pour la marche, nous ne garantissons pas la même tonalité du fond.  
Für die Stufe wird nicht der gleiche Farbton der Grundfliese garantiert.  
Para el peldaño no se garantiza el mismo tono del fondo.  
Для ступени не гарантирована одинаковость тона с фоном.



MULBERRY



OLIVE



SHELL



TAN

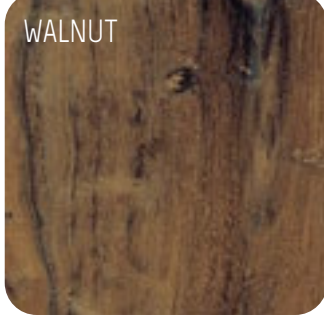

WALNUT



# YOSEMITE

Floor: Mulberry 20x120 (8"x48") Nat. Ret.

GRES PORCELLANATO COLORATO IN MASSA . COLORED BODY PORCELAIN STONEWARE  
GRES CÉRAMÉ COLORÉ DANS LA MASSE . EINGEFÄRBTES FEINSTEINZEUG  
GRES PORCELÁNICO COLOREADO EN MASA . КЕРАМОГРАНИТ ОКРАШЕННЫЙ В МАССЕ  
ISO 13006 - G - B1a (E ≤ 0,5%) - UNI EN 14411 - G

100% DESIGN  
AND PRODUCTION  
OF ITALY

V2  
SHADE SPECTRUM  
MODERATE

INDOOR R10-B (naturale)

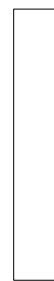

10 mm

20x120 - 8"x48"  
Nat. Ret.

20x120 - 8"x48"  
Lap. Ret.

SVILUPPO GRAFICO PER FORMATO  
Pattern by size  
Développement graphique par format  
Grafischer Entwurf für Format  
Desarrollo gráfico por formato  
Варианты графики для каждого формата

20x120  
10 mm

32



# YOSEMITE

10 mm RIO-B (naturale)



Wall  
AVA Extraordinary Size Calacatta Slab A/B 6 mm Lap. Ret.

Camino / Fireplace  
Tan 20x120 (8"x48") Lap. Ret.

Tavolo e piano / Table and counter top  
AVA Extraordinary Size Calacatta 6/12 mm Lap. Ret.

Floor  
Tan 20x120 (8"x48") Nat. Ret.

# YOSEMITE

## MULBERRY

INDOOR



10 mm R10-B (naturale)

**I21009**  
20x120 . 8"x48"  
Nat. Ret.  
**I21010**  
20x120 . 8"x48"  
Lap. Ret.

## OLIVE

INDOOR



10 mm R10-B (naturale)

**I21005**  
20x120 . 8"x48"  
Nat. Ret.  
**I21006**  
20x120 . 8"x48"  
Lap. Ret.

## SHELL

INDOOR



10 mm R10-B (naturale)

**I21001**  
20x120 . 8"x48"  
Nat. Ret.  
**I21002**  
20x120 . 8"x48"  
Lap. Ret.

## TAN

INDOOR



10 mm R10-B (naturale)

**I21003**  
20x120 . 8"x48"  
Nat. Ret.  
**I21004**  
20x120 . 8"x48"  
Lap. Ret.

## WALNUT

INDOOR



10 mm R10-B (naturale)

**I21007**  
20x120 . 8"x48"  
Nat. Ret.  
**I21008**  
20x120 . 8"x48"  
Lap. Ret.



Floor  
Mulberry 20x120 (8"x48") Nat. Ret.









# YOSEMITE

10 mm RIO-B (naturale)

Solo superficie naturale  
Only natural surface

ANSI A - 137.1: 2012  
WET DYNAMIC COEFFICIENT OF FRICTION

DCOF ≥ 0,42

	20x120 8"x48" Nat. Ret.		20x120 8"x48" Lap. Ret.		Battiscopa Skirting 6,5x120 2 1/2"x48" Nat. Ret.		6,5x120 2 1/2"x48" Lap. Ret.		Gradino costa retta Straight-edge step ** 16x120x3,2h 6 1/4"x48"x1 1/4"h Nat. Ret.		16x120x3,2h 6 1/4"x48"x1 1/4"h Lap. Ret.		Gradino costa retta - Angolo SX / DX Straight-edge step - LH/RH corner ** 16x120x3,2h 6 1/4"x48"x1 1/4"h Nat. Ret.		16x120x3,2h 6 1/4"x48"x1 1/4"h Lap. Ret.		
MULBERRY	I21009	I21010	I21105	I21110	I21213	I21228	I21214 DX I21215 SX	I21229 DX I21230 SX									
OLIVE	I21005	I21006	I21103	I21108	I21207	I21222	I21208 DX I21209 SX	I21223 DX I21224 SX									
SHELL	I21001	I21002	I21101	I21106	I21201	I21216	I21202 DX I21203 SX	I21217 DX I21218 SX									
TAN	I21003	I21004	I21102	I21107	I21204	I21219	I21205 DX I21206 SX	I21220 DX I21221 SX									
WALNUT	I21007	I21008	I21104	I21109	I21210	I21225	I21211 DX I21212 SX	I21226 DX I21227 SX									
PREZZO PRICE	€ 38,00 m <sup>2</sup>	€ 54,00 m <sup>2</sup>	€ 8,00 PZ/PCE	€ 9,00 PZ/PCE	€ 140,00 PZ/PCE		€ 164,00 PZ/PCE										
CODICE PREZZO PRICE CODE	M093	M121	P029	P033	P207		P231										
	<b>Pallet</b> 80x120	<b>Pallet</b> 80x120	<b>Pallet</b> 80x120	<b>Pallet</b> 80x120	<b>Pallet</b> 80x120		<b>Pallet</b> 80x120										
IMBALLO cm h. PACKING cm h.	75	55	-	-	-		-										
 x 	4	6	6	6	2		2										
m <sup>2</sup> x 	0,96	1,44	-	-	-		-										
Kg x 	21,90	31,68	11,04	11,04	23,00		13,00										
 x 	48	24	-	-	-		-										
m <sup>2</sup> x 	46,08	34,56	-	-	-		-										
Kg x 	1.066	780	-	-	-		-										



\*\* A DISPOSIZIONE SOLO SU RICHIESTA. TEMPI DI CONSEGNA: 30GG.  
Available upon request only. Delivery terms: 30 days.  
Disponible seulement sur requête. Délais de livraison: 30 jours.  
Verfügbar auf Anfrage. Lieferzeit: 30 Tage.  
Disponibile sólo bajo pedido. Plazo de entrega: 30 días.  
Изготавливается только по специальной заявке. Срок поставки: 30 дней.

PER IL GRADINO NON SI GARANTISCE LA STESSA TONALITÀ DEL FONDO.  
We cannot guarantee that the shade of the stair tile will be the same as the background tile.  
Pour la marche, nous ne garantissons pas la même tonalité du fond.  
Für die Stufe wird nicht der gleiche Farbton der Grundfliese garantiert.  
Para el peldaño no se garantiza el mismo tono del fondo.  
Для ступени не гарантирована одинаковость тона с фоном.

Floor  
Shell 20x120 (8"x48") Nat. Ret.



Civilization of Beauty

# MARMO E PIETRA

Marble & Stone . Marbres et Pierres . Marmore und Steine . Mármoles y Piedras . Мрамор и Камень .

## INDOOR

ARDESIA .....	88
BLUE EVOLUTION .....	104
CASTLE .....	120
DOLOMITI .....	130
HIGH LINE .....	144
IMPERIAL .....	152
I QUARZI .....	164
JUNGLE STONE .....	176
LE PIETRE D'EUROPA .....	186
MARMI .....	196
PIERRES DES CHÂTEAUX .....	208
PIETRA LAVICA .....	224
ROYAL STONE .....	230
STORM .....	240

## OUTDOOR RII-C

ARDESIA .....	88
BORGHI ITALIANI .....	112
DOLOMITI .....	130
I QUARZI .....	164
LE PIETRE D'EUROPA .....	186
PIERRES DES CHÂTEAUX .....	208
STORM .....	240

## OUTDOOR 20 mm . RII-C

ARDESIA .....	88
BLUE EVOLUTION .....	104
DOLOMITI .....	130
I QUARZI .....	164
LE PIETRE D'EUROPA .....	186
PIERRES DES CHÂTEAUX .....	208
ROYAL STONE .....	230
STORM .....	240

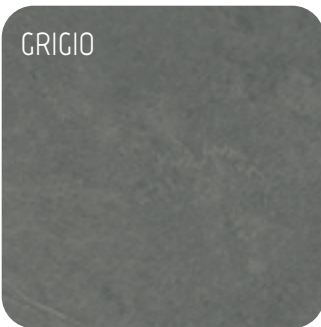

# ARDESIA



INDOOR - Wall: AVA Statuario 320x160 (126"x63") Lap. Ret. / Floor: Grigio 80x80 (31 1/2"x31 1/2") Nat. Ret.  
 OUTDOOR - Floor: Grigio 80x80 (31 1/2"x31 1/2") Nat. Ret. 20mm RII - Grigione bordo grip Grigio 40x80 (16"x31 1/2") Nat. Ret. 20mm RII - Griglia Grigio 20x80 (8"x31 1/2") Nat. Ret. 20mm RII

GRES PORCELLANATO COLORATO IN MASSA . COLORED BODY PORCELAIN STONEWARE  
 GRÉS CÉRAMÉ COLORÉ DANS LA MASSE . EINGEFÄRBTES FEINSTEINZEUG  
 GRES PORCELÁNICO COLOREADO EN MASA . КЕРАМОГРАНИТ ОКРАШЕННЫЙ В МАССЕ  
 ISO 13006 - G - Bla (E ≤ 0,5%) - UNI EN 14411 - G

100% DESIGN  
AND PRODUCTION  
OF ITALY

V2  
SHADE SPECTRUM  
MODERATE

## INDOOR

R10-B

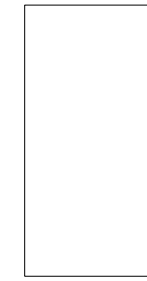

60x120 . 24"x48"  
Nat. Ret.

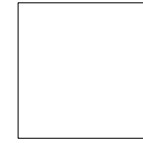

60x60 . 24"x24"  
Nat. Ret.

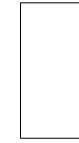

30x60 . 12"x24"  
Nat. Ret.

30,5x60,5 . 12"x24"  
Nat.

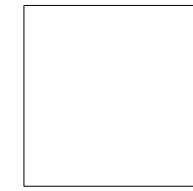

80x80 . 31 1/2"x31 1/2"  
Nat. Ret.

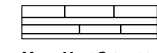

Muretto 3D 15x61 . 6"x24"  
Nat.



Mosaico  
30x30 . 12"x12"  
Nat. Ret.



10 mm

modular system

## OUTDOOR

R11-C



60x120 . 24"x48"  
Nat. Ret.

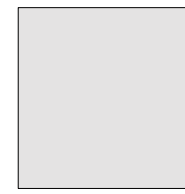

80x80 . 31 1/2"x31 1/2"  
Nat. Ret.

10 mm

R11-C

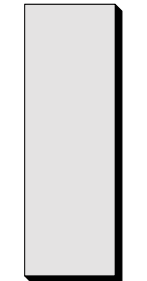

40x120 . 16"x48"  
Nat. Ret.



80x80 . 31 1/2"x31 1/2"  
Nat. Ret.

20 mm

### SVILUPPO GRAFICO PER FORMATO

Pattern by size  
 Développement graphique par format  
 Grafischer Entwurf für Format  
 Desarrollo gráfico por formato  
 Варианты графики для каждого формата

60x120	60x60	30x60	30,5x60,5	80x80	40x120
10 mm	10 mm	10 mm	10 mm	10 mm 20 mm	20 mm
19	31	62	62	23	28

# ARDESIA

10 mm RIO-B



Wall  
Bianco 30x60 (12"x24") Nat. Ret.  
Cenere Mosaico 30x30 (12"x12") Nat. Ret.

Floor  
Bianco 30x60 (12"x24") Nat. Ret.

Wall  
Cenere Muretto 3D 15x61 (6"x24") Nat.

Floor  
Cenere 60x120 (4"x48") Nat. Ret.  
60x60 (24"x24") Nat. Ret.  
30x60 (12"x24") Nat. Ret.

# ARDESIA

## GRIGIO

INDOOR

**10 mm R10-B**

**137004**  
60x120 . 24"x48"  
Nat. Ret.

**137028**  
60x60 . 24"x24"  
Nat. Ret.

**137040**  
30x60 . 12"x24"  
Nat. Ret.

**137016**  
80x80 . 31 1/2"x31 1/2"  
Nat. Ret.

**137204**  
Mosaico  
30x30 . 12"x12"  
Nat. Ret.

**137046**  
Muretto 3D  
15x61 . 6"x24"  
Nat.

modular system

## CENERE

INDOOR

**10 mm R10-B**

**137003**  
60x120 . 24"x48"  
Nat. Ret.

**137027**  
60x60 . 24"x24"  
Nat. Ret.

**137039**  
30x60 . 12"x24"  
Nat. Ret.

**137015**  
80x80 . 31 1/2"x31 1/2"  
Nat. Ret.

**137203**  
Mosaico  
30x30 . 12"x12"  
Nat. Ret.

**137045**  
Muretto 3D  
15x61 . 6"x24"  
Nat.

modular system

## OUTDOOR

**10 mm R11-C**

**137010**  
60x120 . 24"x48"  
Nat. Ret.

**137022**  
80x80 . 31 1/2"x31 1/2"  
Nat. Ret.

**20 mm R11-C**

**137053**  
40x120 . 16"x48"  
Nat. Ret.

**137060**  
80x80 . 31 1/2"x31 1/2"  
Nat. Ret.

## OUTDOOR

**10 mm R11-C**

**137009**  
60x120 . 24"x48"  
Nat. Ret.

**137021**  
80x80 . 31 1/2"x31 1/2"  
Nat. Ret.

**20 mm R11-C**

**137052**  
40x120 . 16"x48"  
Nat. Ret.

**137059**  
80x80 . 31 1/2"x31 1/2"  
Nat. Ret.

# ARDESIA

## TAUPE

INDOOR

**10 mm R10-B**

**I37002**  
60x120 . 24"x48"  
Nat. Ret.

**I37026**  
60x60 . 24"x24"  
Nat. Ret.

**I37038**  
30x60 . 12"x24"  
Nat. Ret.

**I37014**  
80x80 . 31 1/2"x31 1/2"  
Nat. Ret.

**I37202**  
Mosaico  
30x30 . 12"x12"  
Nat. Ret.

**I37044**  
Muretto 3D  
15x61 . 6"x24"  
Nat.

modular system

## BIANCO

INDOOR

**10 mm R10-B**

**I37001**  
60x120 . 24"x48"  
Nat. Ret.

**I37025**  
60x60 . 24"x24"  
Nat. Ret.

**I37037**  
30x60 . 12"x24"  
Nat. Ret.

**I37013**  
80x80 . 31 1/2"x31 1/2"  
Nat. Ret.

**I37201**  
Mosaico  
30x30 . 12"x12"  
Nat. Ret.

**I37043**  
Muretto 3D  
15x61 . 6"x24"  
Nat.

modular system

## OUTDOOR

**10 mm R11-C**

**I37008**  
60x120 . 24"x48"  
Nat. Ret.

**I37020**  
80x80 . 31 1/2"x31 1/2"  
Nat. Ret.

**20 mm R11-C**

**I37051**  
40x120 . 16"x48"  
Nat. Ret.

**I37058**  
80x80 . 31 1/2"x31 1/2"  
Nat. Ret.

## OUTDOOR

**10 mm R11-C**

**I37007**  
60x120 . 24"x48"  
Nat. Ret.









**I37019**  
80x80 . 31 1/2"x31 1/2"  
Nat. Ret.

**20 mm R11-C**

**I37050**  
40x120 . 16"x48"  
Nat. Ret.

**I37057**  
80x80 . 31 1/2"x31 1/2"  
Nat. Ret.



	modular system					Mosaico Mosaic	Muretto 3D Brick-effect mosaic 3D	Battiscopa Skirting	Gradino costa retta Straight-edge step **			Gradino costa retta - Angolo SX / DX Straight-edge step - LH/RH corner **			
	60x120 24"x48" Nat. Ret.	60x60 24"x24" Nat. Ret.	30x60 12"x24" Nat. Ret.	30,5x60,5 12"x24" Nat.	80x80 31 1/2"x31 1/2" Nat. Ret.	30x30 12"x12" Nat. Ret.	15x61 6"x24" Nat.	6,5x120 2 1/2"x48" Nat. Ret.	8x80 3"x31 1/2" Nat. Ret.	33x120x3,2h 13"x48"x1 1/2"h Nat. Ret.	33x80x3,2h 3"x31 1/2"x1 1/2" Nat. Ret.	33x60x3,2h 13"x24"x1 1/2"h Nat. Ret.	33x120x3,2h 13"x48"x1 1/2"h Nat. Ret.	33x80x3,2h 3"x31 1/2"x1 1/2" Nat. Ret.	33x60x3,2h 13"x24"x1 1/2"h Nat. Ret.
GRIGIO	I37004	I37028	I37040	I37034	I37016	I37204	I37046	I37104	I37114	I37350	I37330	I37310	I37352 SX I37351 DX	I37332 SX I37331 DX	I37312 SX I37311 DX
CENERE	I37003	I37027	I37039	I37033	I37015	I37203	I37045	I37103	I37112	I37344	I37324	I37304	I37346 SX I37345 DX	I37326 SX I37325 DX	I37306 SX I37305 DX
TAUPE	I37002	I37026	I37038	I37032	I37014	I37202	I37044	I37102	I37113	I37347	I37327	I37307	I37349 SX I37348 DX	I37329 SX I37328 DX	I37309 SX I37308 DX
BIANCO	I37001	I37025	I37037	I37031	I37013	I37201	I37043	I37101	I37111	I37341	I37321	I37301	I37343 SX I37342 DX	I37323 SX I37322 DX	I37303 SX I37302 DX
PREZZO PRICE	€ 40,00 m <sup>2</sup>	€ 33,00 m <sup>2</sup>	€ 32,00 m <sup>2</sup>	€ 24,00 m <sup>2</sup>	€ 36,00 m <sup>2</sup>	€ 68,00 m <sup>2</sup>	€ 33,00 m <sup>2</sup>	€ 8,00 PZ/PCE	€ 6,00 PZ/PCE	€ 140,00 PZ/PCE	€ 100,00 PZ/PCE	€ 68,00 PZ/PCE	€ 152,00 PZ/PCE	€ 112,00 PZ/PCE	€ 84,00 PZ/PCE
CODICE PREZZO PRICE CODE	M097	M083	M081	M065	M089	M135	M083	P029	P021	P207	P167	P135	P219	P179	P151
	Epal 80x120	Epal 80x120	Epal 80x120	Epal 80x120	Epal 80x120	Epal 80x120	Epal 80x120	Epal 80x120	Epal 80x120	Epal 80x120	Epal 80x120	Epal 80x120	Epal 80x120	Epal 80x120	Epal 80x120
IMBALLO cm h. PACKING cm h.	75	75	75	75	95	75	76	-	-	-	-	-	1	-	-
 x 	2	3	6	8	2	6	11	6	10	2	2	4	-	1	2
m <sup>2</sup> x 	1,44	1,08	1,08	1,48	1,28	0,54	1,02	-	-	-	-	-	-	-	-
Kg x 	33,13	25,38	25,16	33,96	28,80	13,00	19,38	11,04	15,00	23,00	16,00	23,00	12,00	8,50	12,00
 x 	32	40	40	32	40	54	48	-	-	-	-	-	-	-	-
m <sup>2</sup> x 	46,08	43,20	43,20	47,36	51,20	29,16	48,96	-	-	-	-	-	-	-	-
Kg x 	1080	1035	1026	1107	1172	722	950	-	-	-	-	-	-	-	-

TRA I FONDI DI SPESSORE 10 E 20 MM NON SI GARANTISCE L'ABBINABILITÀ.

We cannot guarantee tonal matches between the same background tiles with different thickness (10 or 20 mm).  
Les assortiments des tons ne sont pas garantis pour les fonds d'une épaisseur de 10 et 20 mm.  
Bei Bodenfliesen mit einer Stärke von 10 und 20 mm wird keine Einheitlichkeit der Farbtöne garantiert.  
Para los fondos de espesor 10 y 20 mm no se garantiza la combinabilidad de tonalidades.  
Для фоновой плитки толщиной 10 и 20 мм не гарантирована цветовая сочетаемость.

\*\* A DISPOSIZIONE SOLO SU RICHIESTA. TEMPI DI CONSEGNA: 30GG.

Available upon request only. Delivery terms: 30 days.  
Disponibile soltanto su richiesta. Delais de livraison: 30 jours.  
Verfügbar auf Anfrage. Lieferzeit: 30 Tage.  
Disponibile sólo bajo pedido. Plazo de entrega: 30 días.  
Изготавливается только по специальной заявке. Срок поставки: 30 дней.

PER IL GRADINO NON SI GARANTISCE LA STESSA TONALITÀ DEL FONDO.

We cannot guarantee that the shade of the stair tile will be the same as the background tile.  
Pour la marche, nous ne garantissons pas la même tonalité du fond.  
Für die Stufe wird nicht der gleiche Farbton der Grundfliese garantiert.  
Para el peldaño no se garantiza el mismo tono del fondo.  
Для ступени не гарантирована одинаковость тона с фоном.



10 mm RII-C

ANSI A - I37.1: 2012  
WET DYNAMIC COEFFICIENT OF FRICTION | DCOF ≥ 0,42

	60x120 24"x48" Nat. Ret.	80x80 31 1/2"x31 1/2" Nat. Ret.	33x120x3,2h 13"x48"x1 1/2"h Nat. Ret.	33x80x3,2h 3"x31 1/2"x1 1/2" Nat. Ret.	33x120x3,2h 13"x48"x1 1/2"h Nat. Ret.	33x80x3,2h 3"x31 1/2"x1 1/2" Nat. Ret.	30x120x4h 12"x48"x1 1/2"h Nat. Ret.
GRIGIO	I37010	I37022	I37390	I37370	I37392 SX I37391 DX	I37372 SX I37371 DX	I37154
CENERE	I37009	I37021	I37384	I37364	I37386 SX I37385 DX	I37366 SX I37365 DX	I37153
TAUPE	I37008	I37020	I37387	I37367	I37389 SX I37388 DX	I37369 SX I37368 DX	I37152
BIANCO	I37007	I37019	I37381	I37361	I37383 SX I37382 DX	I37363 SX I37362 DX	I37151
PREZZO PRICE	€ 40,00 m <sup>2</sup>	€ 36,00 m <sup>2</sup>	€ 140,00 PZ/PCE	€ 100,00 PZ/PCE	€ 152,00 PZ/PCE	€ 112,00 PZ/PCE	€ 96,00 PZ/PCE
CODICE PREZZO PRICE CODE	M097	M089	P207	P167	P219	P179	P163
	Epal 80x120	Epal 80x120	Epal 80x120	Epal 80x120	Epal 80x120	Epal 80x120	Epal 80x120
IMBALLO cm h. PACKING cm h.	75	95	-	-	-	-	-
x	2	2	2	2	1	1	2
m <sup>2</sup> x	1,44	1,28	-	-	-	-	-
Kg x	33,13	28,80	23,00	16,00	12,00	8,50	20,00
x	32	40	-	-	-	-	-
m <sup>2</sup> x	46,08	51,20	-	-	-	-	-
Kg x	1080	1172	-	-	-	-	-

INDOOR  
Floor  
Taupe 80x80 (31 1/2"x31 1/2") Nat. Ret.  
Gradino costa retta Taupe 33x80x3,2h (13x31 1/2"x1 1/2") Nat. Ret.

OUTDOOR  
Floor  
Taupe 80x80 (31 1/2"x31 1/2") Nat. Ret. 20 mm RII  
Gradone bordo grip Taupe 40x80 (16x31 1/2") Nat. Ret. 20 mm RII

	 40x120 16"x48" Nat. Ret.	 80x80 31 1/2"x31 1/2" Nat. Ret.	 Gradone bordo svasato Large step with rounded border				 Gradone bordo svasato - Angolo SX / DX Large step with rounded border - Corner SX / DX				 Gradone bordo grip Large step with anti-slip border				 Gradone bordo grip - Angolo SX / DX Large step with anti-slip border - Corner SX / DX				 Gradone bordo 40 Large step 40				 Gradone bordo 40 - Angolo SX / DX Large step 40 - Corner SX / DX			
			C	E	C	E	C	E	C	E	C	E	C	E	C	E	C	E	C	E	C	E				
GRIGIO 	I37053	I37060	I37724	I37712	I37748	I37736	I37732 SX I37728 DX	I37720 SX I37716 DX	I37756 SX I37752 DX	I37744 SX I37740 DX	I37676	I37664	I37700	I37688	I37684 SX I37680 DX	I37672 SX I37668 DX	I37708 SX I37704 DX	I37696 SX I37692 DX	I37628	I37616	I37652	I37640	I37636 SX I37632 DX	I37624 SX I37620 DX	I37660 SX I37656 DX	I37648 SX I37644 DX
CENERE 	I37052	I37059	I37722	I37710	I37746	I37734	I37730 SX I37726 DX	I37718 SX I37714 DX	I37754 SX I37750 DX	I37742 SX I37738 DX	I37674	I37662	I37698	I37686	I37682 SX I37678 DX	I37670 SX I37666 DX	I37706 SX I37702 DX	I37694 SX I37690 DX	I37626	I37614	I37650	I37638	I37634 SX I37630 DX	I37622 SX I37618 DX	I37658 SX I37654 DX	I37646 SX I37642 DX
TAUPE 	I37051	I37058	I37723	I37711	I37747	I37735	I37731 SX I37727 DX	I37719 SX I37715 DX	I37755 SX I37751 DX	I37743 SX I37739 DX	I37675	I37663	I37699	I37687	I37683 SX I37679 DX	I37671 SX I37667 DX	I37707 SX I37703 DX	I37695 SX I37691 DX	I37627	I37615	I37651	I37639	I37635 SX I37631 DX	I37623 SX I37619 DX	I37659 SX I37655 DX	I37647 SX I37643 DX
BIANCO 	I37050	I37057	I37721	I37709	I37745	I37733	I37729 SX I37725 DX	I37717 SX I37713 DX	I37753 SX I37749 DX	I37741 SX I37737 DX	I37673	I37661	I37697	I37685	I37681 SX I37677 DX	I37669 SX I37665 DX	I37705 SX I37701 DX	I37693 SX I37689 DX	I37625	I37613	I37649	I37637	I37633 SX I37629 DX	I37621 SX I37617 DX	I37657 SX I37653 DX	I37645 SX I37641 DX
PREZZO PRICE	€ 64,00 m <sup>2</sup>	€ 70,00 m <sup>2</sup>	€ 288,00 PZ/PCE	€ 256,00 PZ/PCE	€ 190,00 PZ/PCE	€ 168,00 PZ/PCE	€ 308,00 PZ/PCE	€ 276,00 PZ/PCE	€ 208,00 PZ/PCE	€ 186,00 PZ/PCE	€ 160,00 PZ/PCE	€ 140,00 PZ/PCE	€ 104,00 PZ/PCE	€ 92,00 PZ/PCE	€ 178,00 PZ/PCE	€ 158,00 PZ/PCE	€ 122,00 PZ/PCE	€ 110,00 PZ/PCE	€ 136,00 PZ/PCE	€ 76,00 PZ/PCE	€ 88,00 PZ/PCE	€ 76,00 PZ/PCE	€ 154,00 PZ/PCE	€ 94,00 PZ/PCE	€ 106,00 PZ/PCE	€ 94,00 PZ/PCE
CODICE PREZZO PRICE CODE	M131	M137	P311	P295	P257	P235	P321	P305	P271	P253	P227	P207	P171	P159	P245	P225	P189	P177	P203	P143	P155	P143	P221	P161	P173	P161
	<b>Epal</b> 80x120	<b>Epal</b> 80x120	<b>Pallet</b> 80x120		<b>Pallet</b> 80x120		<b>Pallet</b> 80x120	<b>Pallet</b> 80x120			<b>Pallet</b> 80x120	<b>Pallet</b> 80x120	<b>Pallet</b> 80x120	<b>Pallet</b> 80x120	<b>Pallet</b> 80x120	<b>Pallet</b> 80x120	<b>Pallet</b> 80x120	<b>Pallet</b> 80x120	<b>Pallet</b> 80x120	<b>Pallet</b> 80x120	<b>Pallet</b> 80x120	<b>Pallet</b> 80x120	<b>Pallet</b> 80x120	<b>Pallet</b> 80x120	<b>Pallet</b> 80x120	
IMBALLO cm h. PACKING cm h.	75	95	-	-	-	-	-	-	-	-	-	-	-	-	-	-	-	-	-	-	-	-	-	-	-	-
 x 	2	1	1	1	1	1	1	1	1	1	1	1	1	1	1	1	1	1	1	1	1	1	1	1	1	1
m <sup>2</sup> x 	0,96	0,64	-	-	-	-	-	-	-	-	-	-	-	-	-	-	-	-	-	-	-	-	-	-	-	-
Kg x 	43,00	27,77	21,50	12,50	21,50	12,50	21,50	12,50	21,50	12,50	21,50	12,50	21,50	12,50	21,50	12,50	21,50	12,50	21,50	12,50	21,50	12,50	21,50	12,50	21,50	12,50
 x 	24	40	-	-	-	-	-	-	-	-	-	-	-	-	-	-	-	-	-	-	-	-	-	-	-	-
m <sup>2</sup> x 	23,04	25,60	-	-	-	-	-	-	-	-	-	-	-	-	-	-	-	-	-	-	-	-	-	-	-	-
Kg x 	1.052	1.130	-	-	-	-	-	-	-	-	-	-	-	-	-	-	-	-	-	-	-	-	-	-	-	-











**Costa toro.**  
Bullnose edge.  
Bord boudin.  
Abgerundete Kante.  
Canto redondo  
Закругленная кромка



**Costa retta.**  
Straight edge.  
Bord droit.  
Gerade Kante.  
Canto recto  
Прямоугольная кромка

**ATTENZIONE:** Per particolari installazioni potrebbero essere necessari articoli ed accessori specifici non presenti in questo catalogo. Per queste esigenze prego riferirsi direttamente al referente commerciale La Fabbrica.  
N.B. Particular items and accessories not listed in this catalogue may be required for certain laying methods. For these needs, please contact the La Fabbrica sales directly.  
**ATTENTION:** Pour les installations particulières, certains articles et accessoires particuliers qui ne sont pas indiqués dans ce catalogue pourraient être nécessaires. Dans ces cas-là, nous vous prions de vous référer directement à la référence commerciale La Fabbrica.  
**ACHTUNG:** Für besondere Installationen können besondere Artikel oder Sonderzubehör notwendig sein, die nicht im vorliegenden Katalog aufgeführt sind. Wenden Sie sich bitte in diesen Fällen direkt an den Vertrieb von La Fabbrica.  
**ATENCIÓN:** para instalaciones particulares podrían requerirse artículos y accesorios específicos que no están presentes en este catálogo. Para tales casos rogamos contactar directamente al representante comercial de La Fabbrica.  
**ВНИМАНИЕ:** Для особых применений могут быть необходимы специальные артикулы и аксессуары, не представленные в данном каталоге. По поводу этих вопросов просим вас обращаться непосредственно к менеджеру коммерческого отдела компании La Fabbrica.

	Griglia 20 Drainage grid 20		Griglia 20 - Angolo SX / DX Drainage grid 20 - Corner SX / DX		Canalina Channel		Canalina - Angolo SX / DX Channel - Corner SX / DX		Cordolo U-Border		Cordolo - Angolo SX / DX U-Border - Corner SX / DX	
	20x80 8"x31 1/2"	20x60 8"x24"	20x80 8"x31 1/2"	20x60 8"x24"	20x120x8h 8"x48"x3"h	20x80x8h 8"x31 1/2"x3"h	20x120x8h 8"x48"x3"h	20x80x8h 8"x31 1/2"x3"h	13x120x13h 5"x48"x5"h	13x80x13h 5"x31 1/2"x5"h	13x120x13h 5"x48"x5"h	13x80x13h 5"x31 1/2"x5"h
GRIGIO	137772	137760	137780 SX 137776 DX	137768 SX 137764 DX	137568	137580	137576 SX 137572 DX	137588 SX 137584 DX	137592	137604	137600 SX 137596 DX	137612 SX 137608 DX
CENERE	137770	137758	137778 SX 137774 DX	137766 SX 137762 DX	137566	137578	137574 SX 137570 DX	137586 SX 137582 DX	137590	137602	137598 SX 137594 DX	137610 SX 137606 DX
TAUPE	137771	137759	137779 SX 137775 DX	137767 SX 137763 DX	137567	137579	137575 SX 137571 DX	137587 SX 137583 DX	137591	137603	137599 SX 137595 DX	137611 SX 137607 DX
BIANCO	137769	137757	137777 SX 137773 DX	137765 SX 137761 DX	137565	137577	137573 SX 137569 DX	137585 SX 137581 DX	137589	137601	137597 SX 137593 DX	137609 SX 137605 DX
PREZZO PRICE	€ 172,00 PZ/PCE	€ 138,00 PZ/PCE	€ 172,00 PZ/PCE	€ 138,00 PZ/PCE	€ 188,00 PZ/PCE	€ 122,00 PZ/PCE	€ 208,00 PZ/PCE	€ 150,00 PZ/PCE	€ 248,00 PZ/PCE	€ 162,00 PZ/PCE	€ 272,00 PZ/PCE	€ 190,00 PZ/PCE
CODICE PREZZO PRICE CODE	P239	P205	P239	P205	P255	P189	P271	P217	P291	P229	P303	P257
	<b>Pallet 80x120</b>	<b>Pallet 80x120</b>	<b>Pallet 80x120</b>	<b>Pallet 80x120</b>	<b>Pallet 80x120</b>	<b>Pallet 80x120</b>	<b>Pallet 80x120</b>	<b>Pallet 80x120</b>	<b>Pallet 80x120</b>	<b>Pallet 80x120</b>	<b>Pallet 80x120</b>	<b>Pallet 80x120</b>
IMBALLO cm h. PACKING cm h.	-	-	-	-	-	-	-	-	-	-	-	-
 x 	1	1	1	1	1	1	1	1	1	1	1	1
m <sup>2</sup> x 	-	-	-	-	-	-	-	-	-	-	-	-
Kg x 	8,00	6,00	7,50	5,50	21,00	12,00	19,00	13,00	18,00	12,00	19,00	13,00
 x 	-	-	-	-	-	-	-	-	-	-	-	-
m <sup>2</sup> x 	-	-	-	-	-	-	-	-	-	-	-	-
Kg x 	-	-	-	-	-	-	-	-	-	-	-	-

IL PESO DEI PEZZI SPECIALI 20 MM INDICATO IN TABELLA SI RIFERISCE AL PESO DEL SINGOLO PEZZO. PER CALCOLARE IL PESO COMPLESSIVO DEL MATERIALE IMBALLATO OCCORRERÀ AGGIUNGERE AL PESO IN TABELLA IL PESO DELL'IMBALLO E DELLA PALETTA (PESO VARIABILE DA 10 A 30 KG IN FUNZIONE DELLA QUANTITÀ E DELLA TIPOLOGIA DEI PEZZI SPECIALI RICHIESTI).

The weight of the 20 mm TRIMS stated in the table refers to the weight of each trim. To calculate the total weight of the packed material, you will need to add the combined weight of the packing materials and the pallet (weight ranging from 10 to 30kg depending on the quantity and the type of the TRIMS required) to the weight stated in the table.

Le poids des PIÈCES SPECIALES 20 mm indique dans le tableau se réfère au poids individuel de chaque pièce. Pour calculer le poids total du matériel emballé, il faudra ajouter au poids indiqué dans le tableau le poids de l'emballage et de la palette (poids variable de 10 à 30 kg en fonction de la quantité et du type de PIÈCES SPECIALES demandées).

Das in der Tabelle angegebene Gewicht der 20 mm-SONDERTEILE bezieht sich auf das Gewicht des Einzelteils. Zur Berechnung des Gesamtgewichts des verpackten Materials muss zum in der Tabelle aufgeführten Wert das Gewicht der Verpackung und der Palette (von 10 bis 30 kg variierbar in Abhängigkeit von der Menge und Art der gewünschten SONDERTEILE) dazugerechnet werden.

El peso de las PIEZAS ESPECIALES 20 mm indicado en la tabla se refiere al peso de cada pieza singularmente considerada. Para calcular el peso total del material embalado se deberá agregar al peso según la tabla, el peso del embalaje y del palet (peso variable entre 10 y 30 kg en función de la cantidad y tipo de las PIEZAS ESPECIALES requeridas).

Указанный в таблице вес СПЕЦИАЛЬНЫХ ИЗДЕЛИЙ 20 мм - это вес каждого отдельного изделия. Для расчета общего веса упакованного материала необходимо добавить к указанному в таблице значению вес упаковки и поддона (вес может составлять от 10 до 30 кг, в зависимости от количества и типа заказанных СПЕЦИАЛЬНЫХ ИЗДЕЛИЙ)



**Costa toro.**  
Bullnose edge.  
Bord boudin.  
Abgerundete Kante.  
Canto redondo  
Закругленная кромка



**Costa retta.**  
Straight edge.  
Bord droit.  
Gerade Kante.  
Canto recto  
Прямоугольная кромка

**ATTENZIONE:** Per particolari installazioni potrebbero essere necessari articoli ed accessori specifici non presenti in questo catalogo. Per queste esigenze prego riferirsi direttamente al referente commerciale La Fabbrica.

N.B. Particular items and accessories not listed in this catalogue may be required for certain laying methods. For these needs, please contact the La Fabbrica sales sales directly.

ATTENTION : Pour les installations particulières, certains articles et accessoires particuliers qui ne sont pas indiqués dans ce catalogue pourraient être nécessaires. Dans ces cas-là, nous vous prions de vous référer directement à la référence commerciale La Fabbrica.

ACHTUNG: Für besondere Installationen können besondere Artikel oder Sonderzubehör notwendig sein, die nicht im vorliegenden Katalog aufgeführt sind. Wenden Sie sich bitte in diesen Fällen direkt an den Vertrieb von La Fabbrica.

ATENCIÓN: para instalaciones particulares podrían requerirse artículos y accesorios específicos que no están presentes en este catálogo. Para tales casos rogamos contactar directamente al representante comercial de La Fabbrica.

ВНИМАНИЕ: Для особых применений могут быть необходимы специальные артикулы и аксессуары, не представленные в данном каталоге. По поводу этих вопросов просим вас обращаться непосредственно к менеджеру коммерческого отдела компании La Fabbrica.



# BLUE EVOLUTION

Wall: Anthracite 80x80 (31 1/2"x31 1/2") Nat. Ret.

GRES PORCELLANATO COLORATO IN MASSA . COLORED BODY PORCELAIN STONEWARE  
GRES CÉRAME COLORÉ DANS LA MASSE . EINGEFÄRBTES FEINSTEINZEUG  
GRES PORCELÁNICO COLOREADO EN MASA . КЕРАМОГРАНИТ ОКРАШЕННЫЙ В МАССЕ  
ISO 13006 - G - B1a (E ≤ 0,5%) - UNI EN 14411 - G

100% DESIGN  
AND PRODUCTION  
OF ITALY

V2  
SHADE SPECTRUM  
MODERATE

## INDOOR

R10-B

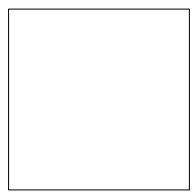

80x80 . 31 1/2"x31 1/2"  
Nat. Ret.

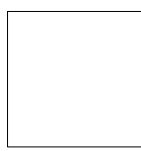

60x60 . 24"x24"  
Nat. Ret.



30x60 . 12"x24"  
Nat. Ret.



20x20 . 8"x8"  
Burrato



Mosaico  
30x30 . 12"x12"  
Nat. Ret.

10 mm

— modular system —

## OUTDOOR

R11-C

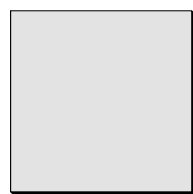

80x80 . 31 1/2"x31 1/2"  
Nat. Ret.

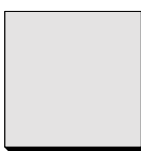

60x60 . 24"x24"  
Nat. Ret.

20 mm

SVILUPPO GRAFICO PER FORMATO  
Pattern by size  
Développement graphique par format  
Grafischer Entwurf für Format  
Desarrollo gráfico por formato  
Варианты графики для каждого формата

80x80	60x60	30x60	20x20
10 mm	10 mm	10 mm	10 mm
20 mm	20 mm		
19	30	60	270

# BLUE EVOLUTION

## BLACK

INDOOR



10 mm R10-B

092015  
80x80 . 31 1/2"x31 1/2"  
Nat. Ret.



092005  
60x60 . 24"x24"  
Nat. Ret.



092025  
30x60 . 12"x24"  
Nat. Ret.

modular system



092035  
20x20 . 8"x8"  
Burattato

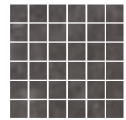

092065  
Mosaico  
30x30 . 12"x12"  
Nat. Ret.

## ANTHRACITE

INDOOR



10 mm R10-B

092013  
80x80 . 31 1/2"x31 1/2"  
Nat. Ret.



092003  
60x60 . 24"x24"  
Nat. Ret.



092023  
30x60 . 12"x24"  
Nat. Ret.

modular system



092033  
20x20 . 8"x8"  
Burattato

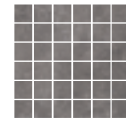

092063  
30x30 . 12"x12"  
Nat. Ret.

## GREY

INDOOR



10 mm R10-B

092011  
80x80 . 31 1/2"x31 1/2"  
Nat. Ret.



092001  
60x60 . 24"x24"  
Nat. Ret.



092021  
30x60 . 12"x24"  
Nat. Ret.

modular system



092031  
20x20 . 8"x8"  
Burattato

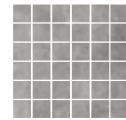

092061  
30x30 . 12"x12"  
Nat. Ret.

OUTDOOR

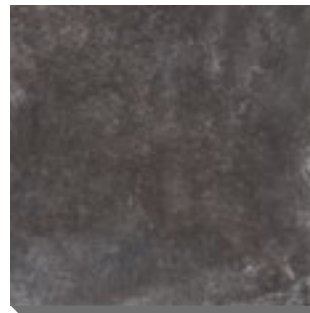

20 mm R11-C



092044  
80x80 . 31 1/2"x31 1/2"  
Nat. Ret.

092045  
60x60 . 24"x24"  
Nat. Ret.

OUTDOOR



20 mm R11-C



092042  
80x80 . 31 1/2"x31 1/2"  
Nat. Ret.

092043  
60x60 . 24"x24"  
Nat. Ret.

OUTDOOR



20 mm R11-C











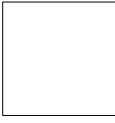
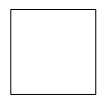

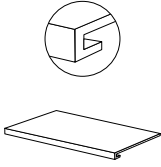
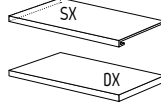

092040  
80x80 . 31 1/2"x31 1/2"  
Nat. Ret.

092041  
60x60 . 24"x24"  
Nat. Ret.

# BLUE EVOLUTION

## 10 mm RIO-B

	modular system				Mosaico Mosaic	Battiscopa Skirting	Gradino costa retta Straight-edge step **	Gradino costa retta - Angolo SX / DX Straight-edge step - LH/RH corner **
	 80x80 31 1/2"x31 1/2" Nat. Ret.	 60x60 24"x24" Nat. Ret.	 30x60 12"x24" Nat. Ret.	 20x20 8"x8" Burattato	 30x30 12"x12" Nat. Ret.	 9,5x60 3 3/4"x24" Nat. Ret.	 33x60x3,2h 13"x24"x1 1/4" h Nat. Ret.	 33x60x3,2h 13"x24"x1 1/4" h Nat. Ret.
BLACK	092015	092005	092025	092035	092065	092075	092086	092088 SX 092087 DX
ANTHRACITE	092013	092003	092023	092033	092063	092073	092083	092085 SX 092084 DX
GREY	092011	092001	092021	092031	092061	092071	092080	092082 SX 092081 DX
PREZZO PRICE	€ 46,00 m <sup>2</sup>	€ 36,00 m <sup>2</sup>	€ 36,00 m <sup>2</sup>	€ 60,00 m <sup>2</sup>	€ 92,00 m <sup>2</sup>	€ 5,00 PZ/PCE	€ 74,00 PZ/PCE	€ 102,00 PZ/PCE
CODICE PREZZO PRICE CODE	M109	M089	M089	M127	M159	P017	P141	P169
	<b>Pallet</b> 80x80	<b>Pallet</b> 60x60	<b>Pallet</b> 30x60	<b>Pallet</b> 20x20	<b>Pallet</b> 30x30	<b>Epal</b> 80x120	<b>Epal</b> 80x120	<b>Epal</b> 80x120
IMBALLO cm h. PACKING cm h.	95	75	75	75	75	-	-	-
 x 	2	3	6	24	6	12	4	2
m <sup>2</sup> x 	1,28	1,08	1,08	0,96	0,54	-	-	-
Kg x 	28,35	24,45	24,46	20,16	11,34	14,52	23,00	12,00
 x 	40	40	40	57	54	-	-	-
m <sup>2</sup> x 	51,20	43,20	43,20	54,72	29,16	-	-	-
Kg x 	1.154	998	998	1.164	632	-	-	-

\*\* A DISPOSIZIONE SOLO SU RICHIESTA. TEMPI DI CONSEGNA: 30GG.

Available upon request only. Delivery terms: 30 days.  
Disponible seulement sur requête. Délais de livraison: 30 jours.  
Verfügbar auf Anfrage. Lieferzeit: 30 Tage.  
Disponibile sólo bajo pedido. Plazo de entrega: 30 días.  
Изготавливается только по специальной заявке. Срок поставки: 30 дней.

PER IL GRADINO NON SI GARANTISCE LA STESSA TONALITÀ DEL FONDO.









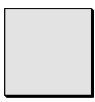
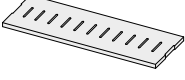

We cannot guarantee that the shade of the stair tile will be the same as the background tile.  
Pour la marche, nous ne garantissons pas la même tonalité du fond.  
Für die Stufe wird nicht der gleiche Farbton der Grundfliese garantiert.  
Para el peldaño no se garantiza el mismo tono del fondo.  
Для ступени не гарантирована одинаковость тона с фоном.

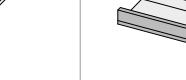
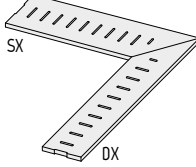
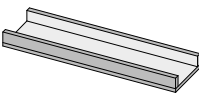
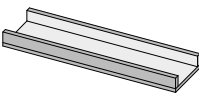
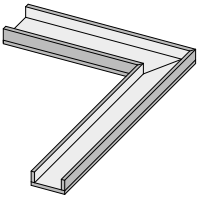
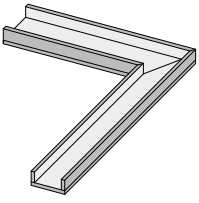
TRA I FONDI DI SPESSORE 10 E 20 MM NON SI GARANTISCE L'ABBINABILITÀ.

We cannot guarantee tonal matches between the same background tiles with different thickness (10 or 20 mm).  
Les assortiments des tons ne sont pas garantis pour les fonds d'une épaisseur de 10 et 20 mm.  
Bei Bodenfliesen mit einer Stärke von 10 und 20 mm wird keine Einheitlichkeit der Farbtöne garantiert.  
Para los fondos de espesor 10 y 20 mm no se garantiza la combinabilidad de tonalidades.  
Для фоновой плитки толщиной 10 и 20 мм не гарантирована цветовая сочетаемость.

## 20 mm RII-C

ANSI A - 137.1: 2012  
WET DYNAMIC COEFFICIENT OF FRICTION | DCOF ≥ 0,42

	Griglia 15 / 20 / 30 Drainage grid 15 / 20 / 30			Griglia 15 / 20 / 30 - Angolo SX / DX Drainagegrid 15/20/30 - Corner SX / DX			Canalina Channel	Canalina - Angolo SX / DX Channel - Corner SX / DX				
	 80x80 31 1/2"x31 1/2" Nat. Ret.	 60x60 24"x24" Nat. Ret.	 15x60 6"x24"	 20x80 8"x31 1/2"	 30x60 12"x24"	 15x60 6"x24"	 20x80x8h 8"x31 1/2"x3" h	 15x60x8h 6"x24"x3" h	 20x80x8h 8"x31 1/2"x3" h	 15x60x8h 6"x24"x3" h		
BLACK	092044	092045	092390	092367	092244	092219 SX 092382 DX	092373 SX 092370 DX	092248 SX 092247 DX	092319	092237	092325 SX 092322 DX	092241 SX 092240 DX
ANTHRACITE	092042	092043	092389	092366	092243	092202 SX 092201 DX	092372 SX 092369 DX	092204 SX 092203 DX	092318	092236	092324 SX 092321 DX	092206 SX 092205 DX
GREY	092040	092041	092388	092365	092242	092200 SX 092199 DX	092371 SX 092368 DX	092246 SX 092245 DX	092317	092235	092323 SX 092320 DX	092239 SX 092238 DX
PREZZO PRICE	€ 70,00 m <sup>2</sup>	€ 50,00 m <sup>2</sup>	€ 128,00 PZ/PCE	€ 172,00 PZ/PCE	€ 150,00 PZ/PCE	€ 128,00 PZ/PCE	€ 172,00 PZ/PCE	€ 150,00 PZ/PCE	€ 122,00 PZ/PCE	€ 90,00 PZ/PCE	€ 150,00 PZ/PCE	€ 108,00 PZ/PCE
CODICE PREZZO PRICE CODE	M137	M117	P195	P239	P217	P195	P239	P217	P189	P157	P217	P175
	<b>Epal</b> 80x120	<b>Epal</b> 80x120	<b>Epal</b> 80x120	<b>Epal</b> 80x120	<b>Epal</b> 80x120	<b>Epal</b> 80x120	<b>Epal</b> 80x120	<b>Epal</b> 80x120	<b>Epal</b> 80x120	<b>Epal</b> 80x120	<b>Epal</b> 80x120	<b>Epal</b> 80x120
IMBALLO cm h. PACKING cm h.	95	75	-	-	-	-	-	-	-	-	-	-
 x 	1	2	1	1	1	1	1	1	1	1	1	1
m <sup>2</sup> x 	0,64	0,72	-	-	-	-	-	-	-	-	-	-
Kg x 	27,78	30,60	4,20	8,00	8,40	3,60	7,50	7,20	12,00	8,00	13,00	7,00
 x 	40	30	-	-	-	-	-	-	-	-	-	-
m <sup>2</sup> x 	25,60	21,60	-	-	-	-	-	-	-	-	-	-
Kg x 	1.131	938	-	-	-	-	-	-	-	-	-	-



**Costa toro.**  
Bullnose edge.  
Bord boudin.  
Abgerundete Kante.  
Canto redondo  
Закругленная кромка



**Costa retta.**  
Straight edge.  
Bord droit.  
Gerade Kante.  
Canto recto  
Прямоугольная кромка

ATTENZIONE: Per particolari installazioni potrebbero essere necessari articoli ed accessori specifici non presenti in questo catalogo. Per queste esigenze prego riferirsi direttamente al referente commerciale La Fabbrica.

N.B. Particular items and accessories not listed in this catalogue may be required for certain laying methods. For these needs, please contact the La Fabbrica sales sales directly.  
ATTENTION: Pour les installations particulières, certains articles et accessoires particuliers qui ne sont pas indiqués dans ce catalogue pourraient être nécessaires. Dans ces cas-là, nous vous prions de vous référer directement à la référence commerciale La Fabbrica.  
ACHTUNG: Für besondere Installationen können besondere Artikel oder Sonderzubehör notwendig sein, die nicht im vorliegenden Katalog aufgeführt sind. Wenden Sie sich bitte in diesen Fällen direkt an den Vertrieb von La Fabbrica.  
ATENCIÓN: para instalaciones particulares podrían requerirse artículos y accesorios específicos que no están presentes en este catálogo. Para tales casos rogamos contactar directamente al representante comercial de La Fabbrica.  
ВНИМАНИЕ: Для особых применений могут быть необходимы специальные артикулы и аксессуары, не представленные в данном каталоге. По поводу этих вопросов просим вас обращаться непосредственно к менеджеру коммерческого отдела компании La Fabbrica.

# BLUE EVOLUTION

20 mm RII-C

ANSI A - 137.1: 2012  
WET DYNAMIC COEFFICIENT OF FRICTION |  $\text{DCOF} \geq 0,42$

	Cordolo U-Border		Cordolo - Angolo SX / DX U-Border - Corner SX / DX		Gradone bordo svasato Large step with rounded border				Gradone bordo svasato - Angolo SX / DX Large step with rounded border Corner SX / DX				Gradone bordo grip Large step with anti-slip border				Gradone bordo grip - Angolo SX / DX Large step with anti-slip border Corner SX / DX				Gradone bordo 15 / 30 / 40 Large step 15 / 30 / 40				Gradone bordo 15 / 30 / 40 SX / DX Large step 15 / 30 / 40 - Corner SX / DX							
	13x80x13h 5"x31 1/2"x5"h	15x60x15h 6"x24"x6"h	13x80x13h 5"x31 1/2"x5"h	15x60x15h 6"x24"x6"h	40x80 16"x31 1/2"	30x60 12"x24"	40x80 16"x31 1/2"	30x60 12"x24"	40x80 16"x31 1/2"	30x60 12"x24"	40x80 16"x31 1/2"	30x60 12"x24"	40x80 16"x31 1/2"	30x60 12"x24"	15x60 6"x24"	40x80 16"x31 1/2"	30x60 12"x24"	15x60 6"x24"	40x80 16"x31 1/2"	30x60 12"x24"	15x60 6"x24"	40x80 16"x31 1/2"	30x60 12"x24"	15x60 6"x24"	40x80 16"x31 1/2"	30x60 12"x24"	15x60 6"x24"					
					C	E	C	E	C	E	C	E	C	E	C	E	C	E	C	E	C	E	C	E	C	E	C	E				
BLACK	092310	092192	092316 SX 092313 DX	092198 SX 092195 DX	092352	092349	092153	092156	092364 SX 092361 DX	092358 SX 092355 DX	092168 SX 092167 DX	092166 SX 092165 DX	092331	092328	092135	092138	092343 SX 092340 DX	092337 SX 092334 DX	092150 SX 092149 DX	092148 SX 092147 DX	092256	092259	092103	092106	092126	092123	092387 SX 092262 DX	092265 SX 092383 DX	092120 SX 092119 DX	092118 SX 092117 DX	092132 SX 092379 DX	092376 SX 092129 DX
ANTHRACITE	092309	092191	092315 SX 092312 DX	092197 SX 092194 DX	092351	092348	092152	092155	092363 SX 092360 DX	092357 SX 092354 DX	092210 SX 092209 DX	092162 SX 092161 DX	092330	092327	092134	092137	092342 SX 092339 DX	092336 SX 092333 DX	092208 SX 092207 DX	092144 SX 092143 DX	092255	092258	092101	092105	092125	092122	092386 SX 092261 DX	092264 SX 092346 DX	092115 SX 092114 DX	092113 SX 092112 DX	092131 SX 092378 DX	092375 SX 092128 DX
GREY	092308	092190	092314 SX 092311 DX	092196 SX 092193 DX	092350	092347	092151	092154	092362 SX 092359 DX	092356 SX 092353 DX	092160 SX 092159 DX	092158 SX 092157 DX	092329	092326	092133	092136	092341 SX 092338 DX	092335 SX 092332 DX	092142 SX 092141 DX	092140 SX 092139 DX	092384	092344	092100	092104	092124	092121	092385 SX 092260 DX	092263 SX 092345 DX	092111 SX 092110 DX	092108 SX 092107 DX	092130 SX 092377 DX	092374 SX 092127 DX
PREZZO PRICE	€ 162,00 PZ/PCE	€ 110,00 PZ/PCE	€ 190,00 PZ/PCE	€ 134,00 PZ/PCE	€ 190,00 PZ/PCE	€ 168,00 PZ/PCE	€ 130,00 PZ/PCE	€ 114,00 PZ/PCE	€ 208,00 PZ/PCE	€ 186,00 PZ/PCE	€ 152,00 PZ/PCE	€ 138,00 PZ/PCE	€ 104,00 PZ/PCE	€ 92,00 PZ/PCE	€ 70,00 PZ/PCE	€ 60,00 PZ/PCE	€ 122,00 PZ/PCE	€ 110,00 PZ/PCE	€ 90,00 PZ/PCE	€ 78,00 PZ/PCE	€ 94,00 PZ/PCE	€ 76,00 PZ/PCE	€ 60,00 PZ/PCE	€ 50,00 PZ/PCE	€ 60,00 PZ/PCE	€ 50,00 PZ/PCE	€ 106,00 PZ/PCE	€ 94,00 PZ/PCE	€ 78,00 PZ/PCE	€ 70,00 PZ/PCE	€ 78,00 PZ/PCE	€ 70,00 PZ/PCE
CODICE PREZZO PRICE CODE	P229	P177	P257	P201	P257	P235	P197	P181	P271	P253	P219	P205	P171	P159	P137	P127	P189	P177	P157	P145	P161	P143	P127	P117	P127	P117	P173	P161	P145	P137	P145	P137
	Epal 80x120	Epal 80x120	Epal 80x120	Epal 80x120	Epal 80x120	Epal 80x120	Epal 80x120	Epal 80x120	Epal 80x120	Epal 80x120	Epal 80x120	Epal 80x120	Epal 80x120	Epal 80x120	Epal 80x120	Epal 80x120	Epal 80x120	Epal 80x120	Epal 80x120	Epal 80x120	Epal 80x120	Epal 80x120	Epal 80x120	Epal 80x120	Epal 80x120	Epal 80x120	Epal 80x120	Epal 80x120	Epal 80x120	Epal 80x120	Epal 80x120	
IMBALLO cm h. PACKING cm h.	-	-	-	-	-	-	-	-	-	-	-	-	-	-	-	-	-	-	-	-	-	-	-	-	-	-	-	-	-	-	-	
	1	1	1	1	1	1	1	1	1	1	1	1	1	1	1	1	1	1	1	1	1	1	1	1	1	1	1	1	1	1	1	
m <sup>2</sup> x	-	-	-	-	-	-	-	-	-	-	-	-	-	-	-	-	-	-	-	-	-	-	-	-	-	-	-	-	-	-	-	
Kg x	21,00	13,50	21,00	13,50	12,50	9,00	12,50	6,60	12,50	9,00	12,50	6,60	12,50	9,00	4,50	12,50	9,00	4,50	12,50	9,00	4,50	12,50	9,00	4,50	12,50	9,00	4,50	12,50	6,60	3,80		
	-	-	-	-	-	-	-	-	-	-	-	-	-	-	-	-	-	-	-	-	-	-	-	-	-	-	-	-	-	-	-	
m <sup>2</sup> x	-	-	-	-	-	-	-	-	-	-	-	-	-	-	-	-	-	-	-	-	-	-	-	-	-	-	-	-	-	-	-	
Kg x	-	-	-	-	-	-	-	-	-	-	-	-	-	-	-	-	-	-	-	-	-	-	-	-	-	-	-	-	-	-	-	

IL PESO DEI PEZZI SPECIALI 20 MM INDICATO IN TABELLA SI RIFERISCE AL PESO DEL SINGOLO PEZZO. PER CALCOLARE IL PESO COMPLESSIVO DEL MATERIALE IMBALLATO OCCORRERÀ AGGIUNGERE AL PESO IN TABELLA IL PESO DELL'IMBALLO E DELLA PALETTA (PESO VARIABILE DA 10 A 30 KG IN FUNZIONE DELLA QUANTITÀ E DELLA TIPOLOGIA DEI PEZZI SPECIALI RICHIESTI).

The weight of the 20 mm TRIMS stated in the table refers to the weight of each trim. To calculate the total weight of the packed material, you will need to add the combined weight of the packing materials and the pallet (weight ranging from 10 to 30kg depending on the quantity and the type of the TRIMS required) to the weight stated in the table.

Le poids des PIÈCES SPECIALES 20 mm indique dans le tableau se réfère au poids individuel de chaque pièce. Pour calculer le poids total du matériel emballé, il faudra ajouter au poids indiqué dans le tableau le poids de l'emballage et de la palette (poids variable de 10 à 30 kg en fonction de la quantité et du type de PIÈCES SPECIALES demandées).

Das in der Tabelle angegebene Gewicht der 20 mm-SONDERTEILE bezieht sich auf das Gewicht des Einzelteils. Zur Berechnung des Gesamtgewichts des verpackten Materials muss zum in der Tabelle aufgeführten Wert das Gewicht der Verpackung und der Palette (von 10 bis 30 kg variierbar in Abhängigkeit von der Menge und Art der gewünschten SONDERTEILE) dazugerechnet werden.

El peso de las PIEZAS ESPECIALES 20 mm indicado en la tabla se refiere al peso de cada pieza singularmente considerada. Para calcular el peso total del material embalado se deberá agregar al peso según la tabla, el peso del embalaje y del palet (peso variable entre 10 y 30 kg en función de la cantidad y tipo de las PIEZAS ESPECIALES requeridas).

Указанный в таблице вес СПЕЦИАЛЬНЫХ ИЗДЕЛИЙ 20 мм - это вес каждого отдельного изделия. Для расчета общего веса упакованного материала необходимо добавить к указанному в таблице значению вес упаковки и поддона (вес может составлять от 10 до 30 кг, в зависимости от количества и типа заказанных СПЕЦИАЛЬНЫХ ИЗДЕЛИЙ)



**Costa toro.**  
Bullnose edge.  
Bord boudin.  
Abgerundete Kante.  
Canto redondo  
Закругленная кромка



**Costa retta.**  
Straight edge.  
Bord droit.  
Gerade Kante.  
Canto recto  
Прямоугольная кромка

**ATTENZIONE:** Per particolari installazioni potrebbero essere necessari articoli ed accessori specifici non presenti in questo catalogo. Per queste esigenze prego riferirsi direttamente al referente commerciale La Fabbrica.

N.B. Particular items and accessories not listed in this catalogue may be required for certain laying methods. For these needs, please contact the La Fabbrica sales sales directly.

ATTENTION : Pour les installations particulières, certains articles et accessoires particuliers qui ne sont pas indiqués dans ce catalogue pourraient être nécessaires. Dans ces cas-là, nous vous prions de vous référer directement à la référence commerciale La Fabbrica.

ACHTUNG: Für besondere Installationen können besondere Artikel oder Sonderzubehör notwendig sein, die nicht im vorliegenden Katalog aufgeführt sind. Wenden Sie sich bitte in diesen Fällen direkt an den Vertrieb von La Fabbrica.

ATENCIÓN: para instalaciones particulares podrían requerirse artículos y accesorios específicos que no están presentes en este catálogo. Para tales casos rogamos contactar directamente al representante comercial de La Fabbrica.

ВНИМАНИЕ: Для особых применений могут быть необходимы специальные артикулы и аксессуары, не представленные в данном каталоге. По поводу этих вопросов просим вас обращаться непосредственно к менеджеру коммерческого отдела компании La Fabbrica.





Floor: Agata 20,3x40,6 (8"x16") Nat. 8,8mm RII-C - Agata 20,3x20,3 (8"x8") Nat. 8,8mm RII-C

GRES PORCELLANATO . PORCELAIN STONEWARE  
GRES CÉRAMÉ . FEINSTEINZEUG  
GRES PORCELÁNICO . КЕРАМОГРАНИТ  
ISO 13006 - G - B1a (E ≤ 0,5%) - UNI EN 14411 - G

100% DESIGN  
AND PRODUCTION  
OF ITALY

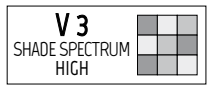

OUTDOOR RII-C

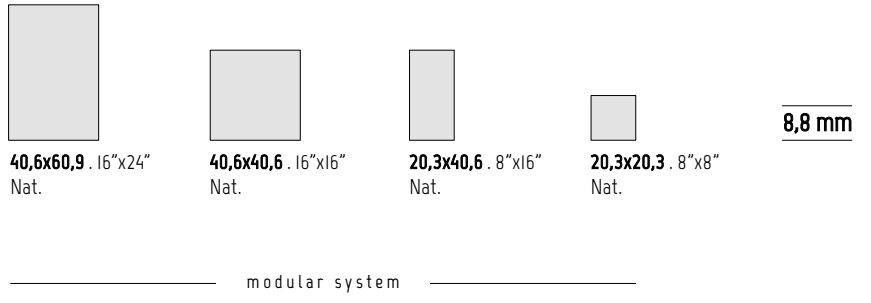

SVILUPPO GRAFICO PER FORMATO Pattern by size Développement graphique par format Grafischer Entwurf für Format Desarrollo gráfico por formato Варианты графики для каждого формата	40,6x60,9 8,8 mm	40,6x40,6 8,8 mm	20,3x40,6 8,8 mm	20,3x20,3 8,8 mm
	15	27	60	56

8,8 mm RII-C



Floor  
Grafite 20,3x20,3 (8"x8") Nat.  
Cenere 20,3x20,3 (8"x8") Nat.



Floor  
Silice 20,3x40,6 (8"x16") Nat.  
Silice 20,3x20,3 (8"x8") Nat.

# BORCHI ITALIANI

## GRAFITE

OUTDOOR



**162014**  
40,6x60,9 . 16"x24"  
Nat.

**8,8 mm RII-C**

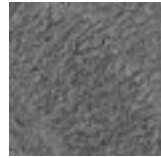

**162024**  
40,6x40,6 . 16"x16"  
Nat.



**162034**  
20,3x40,6 . 8"x16"  
Nat.



**162044**  
20,3x20,3 . 8"x8"  
Nat.

modular system

## AGATA

OUTDOOR



**162012**  
40,6x60,9 . 16"x24"  
Nat.

**8,8 mm RII-C**



**162022**  
40,6x40,6 . 16"x16"  
Nat.



**162032**  
20,3x40,6 . 8"x16"  
Nat.



**162042**  
20,3x20,3 . 8"x8"  
Nat.

modular system

## CENERE

OUTDOOR

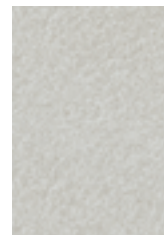

**162011**  
40,6x60,9 . 16"x24"  
Nat.

**8,8 mm RII-C**



**162021**  
40,6x40,6 . 16"x16"  
Nat.



**162031**  
20,3x40,6 . 8"x16"  
Nat.



**162041**  
20,3x20,3 . 8"x8"  
Nat.

modular system

## CALCE

OUTDOOR

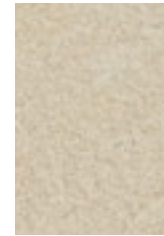

**162010**  
40,6x60,9 . 16"x24"  
Nat.

**8,8 mm RII-C**

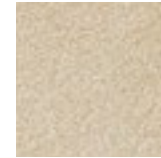

**162020**  
40,6x40,6 . 16"x16"  
Nat.



**162030**  
20,3x40,6 . 8"x16"  
Nat.



**162040**  
20,3x20,3 . 8"x8"  
Nat.

modular system

## SILICE

OUTDOOR

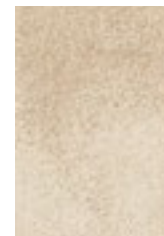

**162013**  
40,6x60,9 . 16"x24"  
Nat.

**8,8 mm RII-C**



**162023**  
40,6x40,6 . 16"x16"  
Nat.



**162033**  
20,3x40,6 . 8"x16"  
Nat.















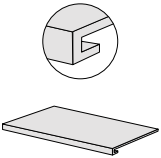
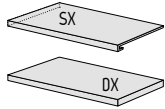
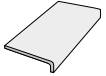





**162043**  
20,3x20,3 . 8"x8"  
Nat.

modular system

8,8 mm RII-C

ANSI A - 137.1: 2012  
WET DYNAMIC COEFFICIENT OF FRICTION | DCOF ≥ 0,42

modular system					Battiscopa Skirting	Gradino costa retta Straight-edge step	Gradino costa retta - Angolo SX / DX Straight-edge step - LH/RH corner	Elle monolit. estruso Extruded L-shaped monoblock tile
								
	40,6x60,9 16"x24" Nat.	40,6x40,6 16"x16" Nat.	20,3x40,6 8"x16" Nat.	20,3x20,3 8"x8" Nat.	7x60,9 3"x24" Nat.	33x60,9x3,2h 13"x24"x1 1/4" Nat.	33x60,9x3,2h 13"x24"x1 1/4" Nat.	10x40,6x5h 4"x16"x2" Nat.
GRAFITE 	I62014	I62024	I62034	I62044	I62105	I62205	I62225 SX I62215 DX	I62405
AGATA 	I62012	I62022	I62032	I62042	I62103	I62203	I62223 SX I62213 DX	I62403
CENERE 	I62011	I62021	I62031	I62041	I62102	I62202	I62222 SX I62212 DX	I62402
CALCE 	I62010	I62020	I62030	I62040	I62101	I62201	I62221 SX I62211 DX	I62401
SILICE 	I62013	I62023	I62033	I62043	I62104	I62204	I62224 SX I62214 DX	I62404
PREZZO PRICE	€ 33,00 m <sup>2</sup>	€ 33,00 m <sup>2</sup>	€ 33,00 m <sup>2</sup>	€ 33,00 m <sup>2</sup>	€ 5,00 PZ/PCE	€ 68,00 PZ/PCE	€ 100,00 PZ/PCE	€ 19,00 PZ/PCE
CODICE PREZZO PRICE CODE	M083	M083	M083	M083	P017	P135	P167	P050
	<b>Epal</b> 80x120	<b>Epal</b> 80x120	<b>Epal</b> 80x120	<b>Epal</b> 80x120	<b>Epal</b> 80x120	<b>Epal</b> 80x120	<b>Epal</b> 80x120	<b>Epal</b> 80x120
IMBALLO cm h. PACKING cm h.	96	96	96	96	-	-	-	75
 x 	6	6	13	30	15	4	2	8
m <sup>2</sup> x 	1,48	0,99	1,07	1,24	0,63	-	-	0,32
Kg x 	31,6	21,63	22,38	27,09	13,76	20	11	8,2
 x 	40	72	72	60	-	-	-	36
m <sup>2</sup> x 	59,2	71,28	77,04	74,4	-	-	-	11,52
Kg x 	1264	1558	1684	1626	-	-	-	296



# CASTLE

Wall: Windsor 60x120 (24"x48") Lap. Ret. - Mosaico 30x30 (12"x12") Nat. Ret. / Lavabo/washbasin: STATUARIO Extraordinary Size collection - AVA  
 Floor: Windsor 20x120 (8"x48") Nat. Ret.

GRES PORCELLANATO COLORATO IN MASSA . COLORED BODY PORCELAIN STONEWARE  
 GRÈS CÉRAME COLORÉ DANS LA MASSE . EINGEFÄRBTES FEINSTEINZEUG  
 GRES PORCELÁNICO COLOREADO EN MASA . КЕРАМОГРАНИТ ОКРАШЕННЫЙ В МАССЕ  
 ISO 13006 - G - B1a (E ≤ 0,5%) - UNI EN 14411 - G

100% DESIGN  
 AND PRODUCTION  
 OF ITALY

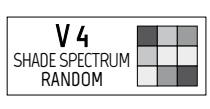

## INDOOR

RI0-A (naturale)

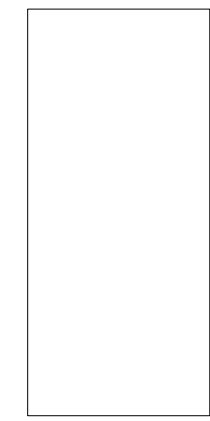

80x180 . 31 1/2"x71"  
Lap. Ret.

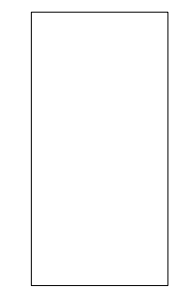

60x120 . 24"x48"  
Lap. Ret.



20x120 . 8"x48"  
Nat. Ret.  
20x120 . 8"x48"  
Lap. Ret.

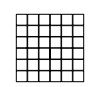

Mosaico  
30x30 . 12"x12"  
Nat. Ret.  
Mosaico  
30x30 . 12"x12"  
Lap. Ret.

10 mm

— modular system —

SVILUPPO GRAFICO PER FORMATO  
 Different patterns (based on size)  
 Différents graphismes par format  
 Je nach Format verschiedene Grafiken  
 Gráficas diferentes según formato  
 Кол. Вариантов графики для каждого формата

80x180	60x120	20x120
10 mm	10 mm	10 mm
14	18	54

# CASTLE

10 mm RIO-A (naturale)



Floor  
Chambord 20x120 (8"x48") Lap. Ret.

# CASTLE

## WINDSOR

INDOOR



**10 mm** RIO-A (naturale)

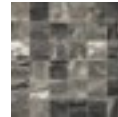

**110019**  
**80x180** . 31 1/2"x71"  
Lap. Ret.

**110009**  
**60x120** . 24"x48"  
Lap. Ret.

**110029**  
**20x120** . 8"x48"  
Nat. Ret.

**110030**  
**20x120** . 8"x48"  
Lap. Ret.

**110079**  
Mosaico  
**30x30 . 12"x12"**  
Nat. Ret.

**110080**  
Mosaico  
**30x30 . 12"x12"**  
Lap. Ret.

———— modular system ————

## PRAGUE

INDOOR



**10 mm** RIO-A (naturale)



**110017**  
**80x180** . 31 1/2"x71"  
Lap. Ret.

**110007**  
**60x120** . 24"x48"  
Lap. Ret.

**110027**  
**20x120** . 8"x48"  
Nat. Ret.

**110028**  
**20x120** . 8"x48"  
Lap. Ret.

**110076**  
Mosaico  
**30x30 . 12"x12"**  
Nat. Ret.

**110077**  
Mosaico  
**30x30 . 12"x12"**  
Lap. Ret.

———— modular system ————

# CASTLE

## CHAMBORD

INDOOR



**10 mm** RIO-A (naturale)



**110015**  
**80x180** . 31 1/2"x71"  
Lap. Ret.



**110025**  
**20x120** . 8"x48"  
Nat. Ret.



**110073**  
Mosaico  
**30x30 . 12"x12"**  
Nat. Ret.

**110026**  
**20x120** . 8"x48"  
Lap. Ret.

**110074**  
Mosaico  
**30x30 . 12"x12"**  
Lap. Ret.

modular system

## BALMORAL

INDOOR

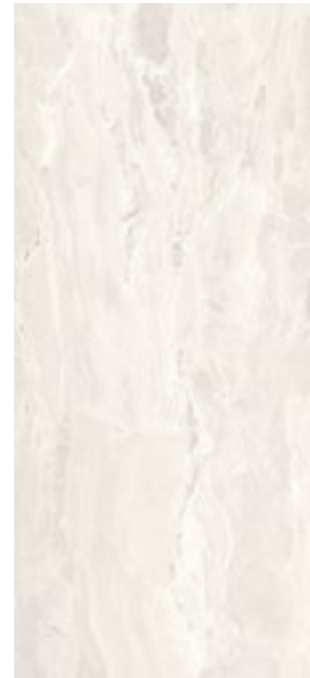

**10 mm** RIO-A (naturale)

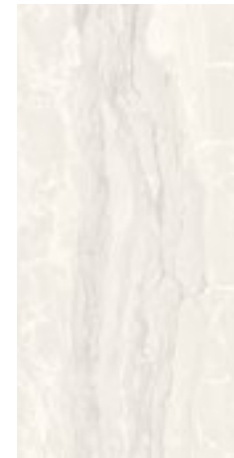

**110011**  
**80x180** . 31 1/2"x71"  
Lap. Ret.



**110021**  
**20x120** . 8"x48"  
Nat. Ret.



**110070**  
Mosaico  
**30x30 . 12"x12"**  
Nat. Ret.

**110022**  
**20x120** . 8"x48"  
Lap. Ret.

**110071**  
Mosaico  
**30x30 . 12"x12"**  
Lap. Ret.

modular system



# CASTLE

10 mm RIO-A (naturale)

Solo superficie naturale  
Only natural surface

ANSI A - 137.1: 2012  
WET DYNAMIC COEFFICIENT OF FRICTION

DCOF ≥ 0,42

	modular system				Mosaico Mosaic		Battiscopa Skirting		Gradino costa retta Straight-edge step **	Gradino costa retta - Angolo SX / DX Straight-edge step - LH/RH corner **
	80x180 31 1/2"x71" Lap. Ret.	60x120 24"x48" Lap. Ret.	20x120 8"x48" Nat. Ret.	20x120 8"x48" Lap. Ret.	30x30 12"x12" Nat. Ret.	30x30 12"x12" Lap. Ret.	6,5x120 2 1/2"x48" Nat. Ret.	6,5x120 2 1/2"x48" Lap. Ret.	33x120x3,2h 13"x48"x1 1/4"h Lap. Ret.	33x120x3,2h 13"x48"x1 1/4"h Lap. Ret.
WINDSOR	110019	110009	110029	110030	110079	110080	110099	110100	110153	110160 SX 110156 DX
PRAGUE	110017	110007	110027	110028	110076	110077	110096	110097	110152	110159 SX 110155 DX
CHAMBORD	110015	110005	110025	110026	110073	110074	110093	110094	110151	110158 SX 110154 DX
BALMORAL	110011	110001	110021	110022	110070	110071	110090	110091	110150	110157 SX 110161 DX
PREZZO PRICE	€ 76,00 m <sup>2</sup>	€ 58,00 m <sup>2</sup>	€ 48,00 m <sup>2</sup>	€ 62,00 m <sup>2</sup>	€ 92,00 m <sup>2</sup>	€ 120,00 m <sup>2</sup>	€ 8,00 PZ/PCE	€ 9,00 PZ/PCE	€ 148,00 PZ/PCE	€ 176,00 PZ/PCE
CODICE PREZZO PRICE CODE	M143	M125	M113	M129	M159	M187	P029	P033	P215	P243
	Pallet con sponde 97x188	Epal 80x120	Epal 80x120	Epal 80x120	Epal 80x120	Epal 80x120	Epal 80x120	Epal 80x120	Epal 80x120	Epal 80x120
IMBALLO cm h. PACKING cm h.	95	75	55	73	55	55	-	-	-	-
x	2	2	6	6	6	6	2	1	-	-
m <sup>2</sup> x	2,88	1,44	1,44	0,54	0,47	0,47	-	-	-	-
Kg x	71,28	32,30	31,82	12,69	10,55	10,55	20,00	11,00	-	-
x	20	30	24	54	45	45	-	-	-	-
m <sup>2</sup> x	57,60	43,20	34,56	29,16	21,15	21,15	-	-	-	-
Kg x	1.456	989	787	705	495	495	-	-	-	-



Floor  
Balmoral 20x120 (8"x48") Nat. Ret.

\*\* A DISPOSIZIONE SOLO SU RICHIESTA. TEMPI DI CONSEGNA: 30GG.  
Available upon request only. Delivery terms: 30 days.  
Disponible seulement sur requête. Délais de livraison: 30 jours.  
Verfügbar auf Anfrage. Lieferzeit: 30 Tage.  
Disponibile sólo bajo pedido. Plazo de entrega: 30 días.  
Изготавливается только по специальной заявке. Срок поставки: 30 дней.

PER IL GRADINO NON SI GARANTISCE LA STESSA TONALITÀ DEL FONDO.  
We cannot guarantee that the shade of the stair tile will be the same as the background tile.  
Pour la marche, nous ne garantissons pas la même tonalité du fond.  
Für die Stufe wird nicht der gleiche Farbton der Grundfliese garantiert.  
Para el peldaño no se garantiza el mismo tono del fondo.  
Для ступени не гарантирована одинаковость тона с фоном.



Wall: Mosaico Cenero 30x30 (12"x12") Bocciardato/Liscio - Mosaico Calcite 30x30 (12"x12") Bocciardato/Liscio / Floor: Calcite 60x120 (24"x48") Liscio Ret.

GRES PORCELLANATO COLORATO IN MASSA . COLORED BODY PORCELAIN STONEWARE  
GRÈS CÉRAMÉ COLORÉ DANS LA MASSE . EINGEFÄRBTES FEINSTEINZEUG  
GRES PORCELÁNICO COLOREADO EN MASA . КЕРАМОГРАНИТ ОКРАШЕННЫЙ В МАССЕ  
ISO 13006 - G - B1a (E ≤ 0,5%) - UNI EN 14411 - G

100% DESIGN  
AND PRODUCTION  
OF ITALY

V2  
SHADE SPECTRUM  
MODERATE

### INDOOR R10-B (Bocciardato e Liscio)

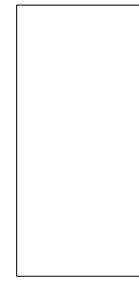

60x120 . 24"x48"  
Liscio Ret.  
60x120 . 24"x48"  
Bocciardato Ret.  
60x120 . 24"x48"  
Liscio Lap. Ret.

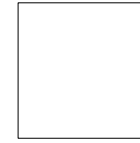

60x60 . 24"x24"  
Liscio Ret.  
60x60 . 24"x24"  
Bocciardato Ret.  
60x60 . 24"x24"  
Liscio Lap. Ret.

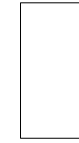

30x60 . 12"x24"  
Liscio Ret.  
30x60 . 12"x24"  
Bocciardato Ret.  
30x60 . 12"x24"  
Liscio Lap. Ret.  
30,5x60,5 . 12"x24"  
Bocciardato Ret.



Mosaico  
30x30 . 12"x12"  
Bocciardato Lap.  
Mosaico  
30x30 . 12"x12"  
Bocciardato Liscio

10 mm

modular system

### OUTDOOR R11-C



60x120 . 24"x48"  
Strut. Ret.



60x60 . 24"x24"  
Strut. Ret.



30,5x60,5 . 12"x24"  
Strut. Ret.

10 mm

modular system

### R11-C



40x120 . 16"x48"  
Strut. Ret.

20 mm

SVILUPPO GRAFICO PER FORMATO  
Pattern by size  
Développement graphique par format  
Grafischer Entwurf für Format  
Desarrollo gráfico por formato  
Варианты графики для каждого формата

60x120	60x60	30x60	30,5x60,5	40x120
10 mm	10 mm	10 mm	10 mm	20 mm
19	44	12	12	24

BASALTO

INDOOR



10 mm R10-B (Bocciardato e Liscio)

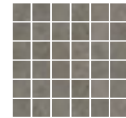

**086019**  
60x120 . 24"x48"  
Liscio. Ret.

**086020**  
60x120 . 24"x48"  
Bocciardato Ret.

**086021**  
60x120 . 24"x48"  
Liscio Lap. Ret.

**086059**  
60x60 . 24"x24"  
Liscio. Ret.

**086060**  
60x60 . 24"x24"  
Bocciardato Ret.

**086061**  
60x60 . 24"x24"  
Liscio Lap. Ret.

**086117**  
30x60 . 12"x24"  
Liscio. Ret.

**086118**  
30x60 . 12"x24"  
Bocciardato Ret.

**086119**  
30x60 . 12"x24"  
Liscio Lap. Ret.

**086089**  
30,5x60,5 . 12"x24"  
Liscio Nat.

**086090**  
30,5x60,5 . 12"x24"  
Bocciardato Nat.

**086158**  
Mosaico (Tessere 5x5)  
30x30 . 12"x12"  
Bocc./Lap.

**086168**  
Mosaico (Tessere 5x5)  
30x30 . 12"x12"  
Bocc./Liscio

modular system

OUTDOOR



10 mm R11-C

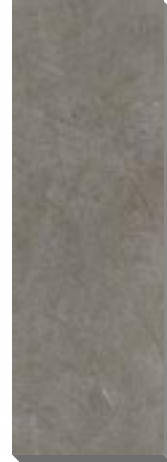

20 mm R11-C

**086022**  
60x120 . 24"x48"  
Strut. Ret.

**086062**  
60x60 . 24"x24"  
Strut. Ret.

**086091**  
30,5x60,5 . 12"x24"  
Strut. Nat.

**086034**  
40x120 . 16"x48"  
Strut. Ret.

modular system

CENERE

INDOOR



10 mm R10-B (Bocciardato e Liscio)

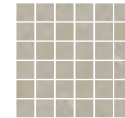
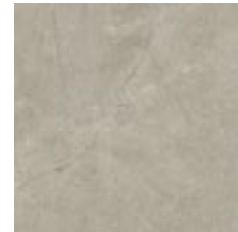

**086013**  
60x120 . 24"x48"  
Liscio. Ret.

**086014**  
60x120 . 24"x48"  
Bocciardato Ret.

**086015**  
60x120 . 24"x48"  
Liscio Lap. Ret.

**086053**  
60x60 . 24"x24"  
Liscio. Ret.

**086054**  
60x60 . 24"x24"  
Bocciardato Ret.

**086055**  
60x60 . 24"x24"  
Liscio Lap. Ret.

**086111**  
30x60 . 12"x24"  
Liscio. Ret.

**086112**  
30x60 . 12"x24"  
Bocciardato Ret.

**086113**  
30x60 . 12"x24"  
Liscio Lap. Ret.

**086083**  
30,5x60,5 . 12"x24"  
Liscio Nat.

**086084**  
30,5x60,5 . 12"x24"  
Bocciardato Nat.

**086157**  
Mosaico (Tessere 5x5)  
30x30 . 12"x12"  
Bocc./Lap.

**086167**  
Mosaico (Tessere 5x5)  
30x30 . 12"x12"  
Bocc./Liscio

modular system

OUTDOOR

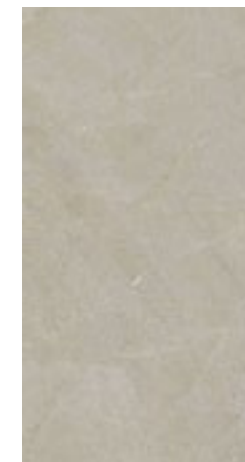

10 mm R11-C

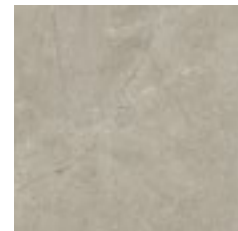

20 mm R11-C

**086016**  
60x120 . 24"x48"  
Strut. Ret.

**086056**  
60x60 . 24"x24"  
Strut. Ret.

**086085**  
30,5x60,5 . 12"x24"  
Strut. Nat.

**086033**  
40x120 . 16"x48"  
Strut. Ret.

modular system

CALCITE

INDOOR

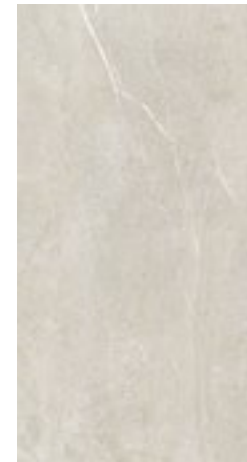

**10 mm** R10-B (Bocciardato e Liscio)

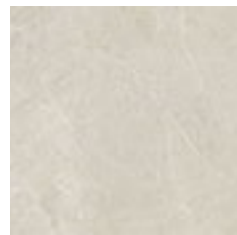

**086001**  
60x120 . 24"x48"  
Liscio. Ret.

**086002**  
60x120 . 24"x48"  
Bocciardato Ret.

**086003**  
60x120 . 24"x48"  
Liscio Lap. Ret.

**086041**  
60x60 . 24"x24"  
Liscio. Ret.

**086042**  
60x60 . 24"x24"  
Bocciardato Ret.

**086043**  
60x60 . 24"x24"  
Liscio Lap. Ret.

**086101**  
30x60 . 12"x24"  
Liscio. Ret.

**086102**  
30x60 . 12"x24"  
Bocciardato Ret.

**086103**  
30x60 . 12"x24"  
Liscio Lap. Ret.

**086071**  
30,5x60,5 . 12"x24"  
Liscio Nat.

**086072**  
30,5x60,5 . 12"x24"  
Bocciardato Nat.

**086155**  
Mosaico (Tessere 5x5)  
30x30 . 12"x12"  
Bocc./Lap.

**086165**  
Mosaico (Tessere 5x5)  
30x30 . 12"x12"  
Bocc./Liscio

modular system

OUTDOOR

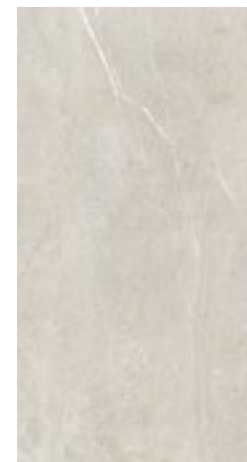

**10 mm** R11-C

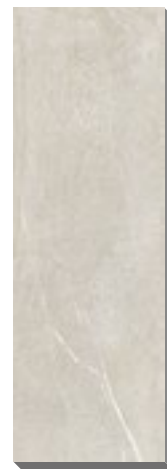
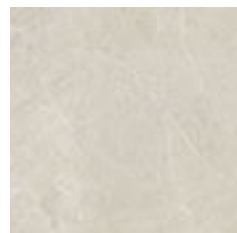

**20 mm** R11-C

**086004**  
60x120 . 24"x48"  
Strut. Ret.

**086044**  
60x60 . 24"x24"  
Strut. Ret.

**086073**  
30,5x60,5 . 12"x24"  
Strut. Nat.

**086031**  
40x120 . 16"x48"  
Strut. Ret.

modular system

SABBIA

INDOOR

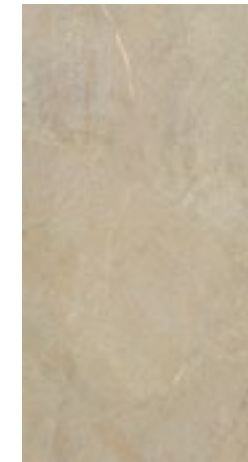

**10 mm** R10-B (Bocciardato e Liscio)

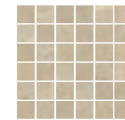
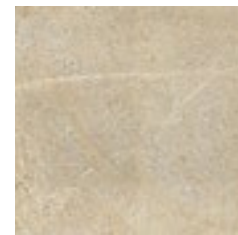

**086007**  
60x120 . 24"x48"  
Liscio. Ret.

**086008**  
60x120 . 24"x48"  
Bocciardato Ret.

**086009**  
60x120 . 24"x48"  
Liscio Lap. Ret.

**086047**  
60x60 . 24"x24"  
Liscio. Ret.

**086048**  
60x60 . 24"x24"  
Bocciardato Ret.

**086049**  
60x60 . 24"x24"  
Liscio Lap. Ret.

**086107**  
30x60 . 12"x24"  
Liscio. Ret.

**086108**  
30x60 . 12"x24"  
Bocciardato Ret.

**086109**  
30x60 . 12"x24"  
Liscio Lap. Ret.

**086077**  
30,5x60,5 . 12"x24"  
Liscio Nat.

**086078**  
30,5x60,5 . 12"x24"  
Bocciardato Nat.

**086156**  
Mosaico (Tessere 5x5)  
30x30 . 12"x12"  
Bocc./Lap.

**086166**  
Mosaico (Tessere 5x5)  
30x30 . 12"x12"  
Bocc./Liscio

modular system

OUTDOOR

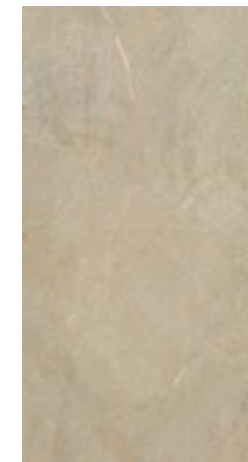

**10 mm** R11-C

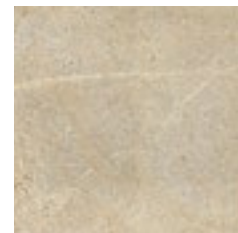

**20 mm** R11-C

**086010**  
60x120 . 24"x48"  
Strut. Ret.

**086050**  
60x60 . 24"x24"  
Strut. Ret.









**086079**  
30,5x60,5 . 12"x24"  
Strut. Nat.

**086032**  
40x120 . 16"x48"  
Strut. Ret.

modular system

# DOLOMITI

10 mm R10-B (Bocciardato e Liscio)

modular system													Mosaico Mosaic	
	60x120 24"x48" Liscio Ret.	60x120 24"x48" Bocc. Ret.	60x120 24"x48" Liscio Lap. Ret.	60x60 24"x24" Liscio Ret.	60x60 24"x24" Bocc. Ret.	60x60 24"x24" Liscio Lap. Ret.	30x60 12"x24" Liscio Ret.	30x60 12"x24" Bocc. Ret.	30x60 12"x24" Liscio Lap. Ret.	30,5x60,5 12"x24" Liscio Nat.	30,5x60,5 12"x24" Bocc. Nat.		30x30 12"x12" Bocc. Lap.	30x30 12"x12" Bocc. Liscio
BASALTO	086019	086020	086021	086059	086060	086061	086117	086118	086119	086089	086090		086158	086168
CENERE	086013	086014	086015	086053	086054	086055	086111	086112	086113	086083	086084		086157	086167
CALCITE	086001	086002	086003	086041	086042	086043	086101	086102	086103	086071	086072		086155	086165
SABBIA	086007	086008	086009	086047	086048	086049	086107	086108	086109	086077	086078		086156	086166
PREZZO PRICE	€ 46,00 m <sup>2</sup>	€ 46,00 m <sup>2</sup>	€ 58,00 m <sup>2</sup>	€ 36,00 m <sup>2</sup>	€ 36,00 m <sup>2</sup>	€ 48,00 m <sup>2</sup>	€ 36,00 m <sup>2</sup>	€ 36,00 m <sup>2</sup>	€ 48,00 m <sup>2</sup>	€ 28,00 m <sup>2</sup>	€ 28,00 m <sup>2</sup>		€ 92,00 m <sup>2</sup>	€ 92,00 m <sup>2</sup>
CODICE PREZZO PRICE CODE	M109	M109	M125	M089	M089	M113	M089	M089	M113	M073	M073		M159	M159
	Epal 80x120			Epal 80x120			Epal 80x120			Epal 80x120			Epal 80x120	
IMBALLO cm h. PACKING cm h.	75			75			75			75			75	
 x 	2			3			6			8			6	
m <sup>2</sup> x 	1,44			1,08			1,08			1,48			0,54	
Kg x 	33,00			25,30			25,06			33,65			13,00	
 x 	32			40			48			32			54	
m <sup>2</sup> x 	46,08			43,20			51,24			47,36			29,16	
Kg x 	1.076			1.035			1.222			1.096			720	

Solo superficie naturale  
Only natural surface

ANSI A - 137.1: 2012  
WET DYNAMIC COEFFICIENT OF FRICTION

DCOF ≥ 0,42



Floor  
Ceneri 60x60 (24"x24") Nat. Ret.

# DOLOMITI

10 mm RIO-B (Bocciardato e Liscio)

Solo superficie naturale  
Only natural surface

ANSI A - 137.1: 2012  
WET DYNAMIC COEFFICIENT OF FRICTION

DCOF ≥ 0,42

	Battiscopa Skirting			Gradino costa retta Straight-edge step **						Gradino costa retta - Angolo SX / DX Straight-edge step - LH/RH corner **					
	9,5x60 3 3/4"x24" Liscio Ret.	9,5x60 3 3/4"x24" Bocciardato Ret.	9,5x60 3 3/4"x24" Liscio Lap. Ret.	33x120x3,2h 13"x48"x1 1/2"h Liscio Ret.	33x120x3,2h 13"x48"x1 1/2"h Bocc. Ret.	33x120x3,2h 13"x48"x1 1/2"h Liscio Lap. Ret.	33x60x3,2h 13"x24"x1 1/2"h Liscio Ret.	33x60x3,2h 13"x24"x1 1/2"h Bocc. Ret.	33x60x3,2h 13"x24"x1 1/2"h Liscio Lap. Ret.	33x120x3,2h 13"x48"x1 1/2"h Liscio Ret.	33x120x3,2h 13"x48"x1 1/2"h Bocciardato Ret.	33x120x3,2h 13"x48"x1 1/2"h Liscio Lap. Ret.	33x60x3,2h 13"x24"x1 1/2"h Liscio Ret.	33x60x3,2h 13"x24"x1 1/2"h Bocciardato Ret.	33x60x3,2h 13"x24"x1 1/2"h Liscio Lap. Ret.
BASALTO	086193	086194	086195	086613	086615	086614	086664	086665	086666	086645 SX 086628 DX	086647 SX 086629 DX	086646 SX 086630 DX	086831 SX 086819 DX	086832 SX 086820 DX	086833 SX 086821 DX
CENERE	086187	086188	086189	086609	086611	086610	086803	086801	086809	086641 SX 086625 DX	086643 SX 086627 DX	086642 SX 086626 DX	086828 SX 086816 DX	086829 SX 086817 DX	086830 SX 086818 DX
CALCITE	086175	086176	086177	086601	086603	086604	086802	086804	086805	086631 SX 086619 DX	086632 SX 086620 DX	086633 SX 086621 DX	086822 SX 086810 DX	086823 SX 086811 DX	086824 SX 086812 DX
SABBIA	086181	086182	086183	086606	086607	086608	086806	086807	086808	086634 SX 086622 DX	086635 SX 086623 DX	086636 SX 086624 DX	086825 SX 086813 DX	086826 SX 086814 DX	086827 SX 086815 DX
PREZZO PRICE	€ 5,00 PZ/PCE	€ 5,00 PZ/PCE	€ 6,00 PZ/PCE	€ 140,00 PZ/PCE	€ 140,00 PZ/PCE	€ 148,00 PZ/PCE	€ 74,00 PZ/PCE	€ 74,00 PZ/PCE	€ 76,00 PZ/PCE	€ 164,00 PZ/PCE	€ 164,00 PZ/PCE	€ 176,00 PZ/PCE	€ 102,00 PZ/PCE	€ 102,00 PZ/PCE	€ 106,00 PZ/PCE
CODICE PREZZO PRICE CODE	P017	P017	P021	P207	P207	P215	P141	P141	P143	P231	P231	P243	P169	P169	P173
	Epal 80x120			Epal 80x120			Epal 80x120			Epal 80x120			Epal 80x120		
IMBALLO cm h. PACKING cm h.	-			-			-			-			-		
 x 	12			2			4			1			2		
m <sup>2</sup> x 	-			-			-			-			-		
Kg x 	14,50			23,00			23,00			12,00			12,00		
 x 	-			-			-			-			-		
m <sup>2</sup> x 	-			-			-			-			-		
Kg x 	-			-			-			-			-		











Floor  
Sabbia 60x120 (24"x48") Nat. Ret.

Floor  
Sabbia 60x120 (24"x48") Nat. Ret.

\*\* A DISPOSIZIONE SOLO SU RICHIESTA. TEMPI DI CONSEGNA: 30GG.  
Available upon request only. Delivery terms: 30 days.  
Disponible seulement sur requête. Délais de livraison: 30 jours.  
Verfügbar auf Anfrage. Lieferzeit: 30 Tage.  
Disponibile sólo bajo pedido. Plazo de entrega: 30 días.  
Изготавливается только по специальной заявке. Срок поставки: 30 дней.

PER IL GRADINO NON SI GARANTISCE LA STESSA TONALITÀ DEL FONDO.  
We cannot guarantee that the shade of the stair tile will be the same as the background tile.  
Pour la marche, nous ne garantissons pas la même tonalité du fond.  
Für die Stufe wird nicht der gleiche Farbton der Grundfliese garantiert.  
Para el peldaño no se garantiza el mismo tono del fondo.  
Для ступени не гарантирована одинаковость тона с фоном.









## 10 mm RII-C

	modular system		
	60x120 24"x48" Strut Ret.	60x60 24"x24" Strut Ret.	30,5x60,5 12"x24" Strut Nat.
BASALTO	086022	086062	086091
CENERE	086016	086056	086085
CALCITE	086004	086044	086073
SABBIA	086010	086050	086079
PREZZO PRICE	€ 46,00 m <sup>2</sup>	€ 36,00 m <sup>2</sup>	€ 28,00 m <sup>2</sup>
CODICE PREZZO PRICE CODE	M109	M089	M073
	<b>Epal</b> 80x120	<b>Epal</b> 80x120	<b>Epal</b> 80x120
IMBALLO cm h. PACKING cm h.	75	75	75
 x 	2	3	8
m <sup>2</sup> x 	1,44	1,08	1,48
Kg x 	33,00	25,30	33,65
 x 	32	40	32
m <sup>2</sup> x 	46,08	43,20	47,36
Kg x 	1076	1035	1096



Floor  
40x120 (16"x48") 20mm Strut. Ret. RII

## 20 mm RII-C

	40x120 16"x48" Strut Ret.	Griglia 20 Drainage grid 20	Griglia 20 - Angolo SX / DX Drainage grid 20 - Corner SX / DX	Gradone bordo 40 Large step 40	Gradone bordo 40 - Angolo SX / DX Large step 40 - Corner SX / DX
BASALTO	086034	086356	086360 SX 086352 DX	086236	086230
CENERE	086033	086355	086359 SX 086351 DX	086235	086229
CALCITE	086031	086353	086357 SX 086349 DX	086233	086227
SABBIA	086032	086354	086358 SX 086350 DX	086234	086228
PREZZO PRICE	€ 64,00 m <sup>2</sup>	€ 138,00 PZ/PCE	€ 138,00 PZ/PCE	€ 136,00 PZ/PCE	€ 116,00 PZ/PCE
CODICE PREZZO PRICE CODE	M131	P205	P205	P203	P183
	<b>Epal</b> 80x120	<b>Epal</b> 80x120		<b>Epal</b> 80x120	
IMBALLO cm h. PACKING cm h.	75	-		-	
 x 	2	1		1	
m <sup>2</sup> x 	0,96	-		-	
Kg x 	43,01	6,00		22,50	
 x 	24	-		-	
m <sup>2</sup> x 	23,04	-		-	
Kg x 	1.052	-		-	



**Costa toro.**  
Bullnose edge.  
Bord boudin.  
Abgerundete Kante.  
Canto redondo  
Закругленная кромка



**Costa retta.**  
Straight edge.  
Bord droit.  
Gerade Kante.  
Canto recto  
Прямоугольная кромка

**ATTENZIONE:** Per particolari installazioni potrebbero essere necessari articoli ed accessori specifici non presenti in questo catalogo. Per queste esigenze prego riferirsi direttamente al referente commerciale La Fabbrica.  
**N.B.** Particular items and accessories not listed in this catalogue may be required for certain laying methods. For these needs, please contact the La Fabbrica sales directly.  
**ATTENTION:** Pour les installations particulières, certains articles et accessoires particuliers qui ne sont pas indiqués dans ce catalogue pourraient être nécessaires. Dans ces cas-là, nous vous prions de vous référer directement à la référence commerciale La Fabbrica.  
**ACHTUNG:** Für besondere Installationen können besondere Artikel oder Sonderzubehör notwendig sein, die nicht im vorliegenden Katalog aufgeführt sind. Wenden Sie sich bitte in diesen Fällen direkt an den Vertrieb von La Fabbrica.  
**ATENCIÓN:** para instalaciones particulares podrían requerirse artículos y accesorios específicos que no están presentes en este catálogo. Para tales casos rogamos contactar directamente al representante comercial de La Fabbrica.  
**ВНИМАНИЕ:** Для особых применений могут быть необходимы специальные артикулы и аксессуары, не представленные в данном каталоге. По поводу этих вопросов просим вас обращаться непосредственно к менеджеру коммерческого отдела компании La Fabbrica.

ANSI A - 137.1: 2012  
WET DYNAMIC COEFFICIENT OF FRICTION | DCOF ≥ 0,42

	Gradone bordo grip Large step with anti-slip border		Gradone bordo grip - Angolo SX / DX Large step with anti-slip border Corner SX / DX		Gradone bordo svasato Large step with rounded border		Gradone bordo svasato - Angolo SX / DX Large step with rounded border - Corner SX / DX		Canalina Channel	Canalina - Angolo SX / DX Channel - Corner SX / DX	Cordolo U-Border	Cordolo - Angolo SX / DX U-Border - Corner SX / DX
	40x120 16"x48"		40x120 16"x48"		40x120 16"x48"		40x120 16"x48"		20x120x8h 8"x48"x3"h	20x120x8h 8"x48"x3"h	13x120x13h 5"x48"x5"h	13x120x13h 5"x48"x5"h
	C	E	C	E	C	E	C	E				
BASALTO	086272	086266	086296 SX 086284 DX	086290 SX 086278 DX	086308	086302	086324 SX 086316 DX	086320 SX 086312 DX	086338	086334 SX 086330 DX	086340	086348 SX 086344 DX
CENERE	086271	086265	086295 SX 086283 DX	086289 SX 086277 DX	086307	086301	086323 SX 086315 DX	086319 SX 086311 DX	086326	086333SX 086329 DX	086339	086347 SX 086343 DX
CALCITE	086269	086263	086293 SX 086281 DX	086287 SX 086275 DX	086305	086299	086321 SX 086313 DX	086317 SX 086309 DX	086335	086331 SX 086327 DX	086336	086345 SX 086341 DX
SABBIA	086270	086264	086294 SX 086282 DX	086288 SX 086276 DX	086306	086300	086322 SX 086314 DX	086318 SX 086310 DX	086325	086332 SX 086328 DX	086337	086346 SX 086342 DX
PREZZO PRICE	€ 160,00 PZ/PCE	€ 140,00 PZ/PCE	€ 178,00 PZ/PCE	€ 158,00 PZ/PCE	€ 288,00 PZ/PCE	€ 256,00 PZ/PCE	€ 178,00 PZ/PCE	€ 158,00 PZ/PCE	€ 188,00 PZ/PCE	€ 208,00 PZ/PCE	€ 308,00 PZ/PCE	€ 276,00 PZ/PCE
CODICE PREZZO PRICE CODE	P227	P207	P245	P225	P311	P295	P245	P225	P255	P271	P321	P305
	Epal 80x120		Epal 80x120		Epal 80x120		Epal 80x120		Epal 80x120	Epal 80x120	Epal 80x120	Epal 80x120
IMBALLO cm h. PACKING cm h.	-		-		-		-		-	-	-	-
 x 	1		1		1		1		1	1	1	1
m <sup>2</sup> x 	-		-		-		-		-	-	-	-
Kg x 	22,50		22,50		22,50		22,50		21,00	21,00	19,00	19,00
 x 	-		-		-		-		-	-	-	-
m <sup>2</sup> x 	-		-		-		-		-	-	-	-
Kg x 	-		-		-		-		-	-	-	-

IL PESO DEI PEZZI SPECIALI 20 MM INDICATO IN TABELLA SI RIFERISCE AL PESO DEL SINGOLO PEZZO. PER CALCOLARE IL PESO COMPLESSIVO DEL MATERIALE IMBALLATO OCCORRERÀ AGGIUNGERE AL PESO IN TABELLA IL PESO DELL'IMBALLO E DELLA PALETTA (PESO VARIABILE DA 10 A 30 KG IN FUNZIONE DELLA QUANTITÀ E DELLA TIPOLOGIA DEI PEZZI SPECIALI RICHIESTI).

The weight of the 20 mm TRIMS stated in the table refers to the weight of each trim. To calculate the total weight of the packed material, you will need to add the combined weight of the packing materials and the pallet

(weight ranging from 10 to 30kg depending on the quantity and the type of the TRIMS required) to the weight stated in the table.

Le poids des PIÈCES SPECIALES 20 mm indique dans le tableau se réfère au poids individuel de chaque pièce. Pour calculer le poids total du matériel emballé, il faudra ajouter au poids indiqué dans le tableau le poids de l'emballage et de la palette

(poids variable de 10 à 30 kg en fonction de la quantité et du type de PIÈCES SPECIALES demandées).

Das in der Tabelle angegebene Gewicht der 20 mm-SONDERTEILE bezieht sich auf das Gewicht des Einzelteils. Zur Berechnung des Gesamtgewichts des verpackten Materials muss zum in der Tabelle aufgeführten Wert das Gewicht der Verpackung und der Palette (von 10 bis 30 kg variierbar in Abhängigkeit von der Menge und Art der gewünschten SONDERTEILE) dazugerechnet werden.

El peso de las PIEZAS ESPECIALES 20 mm indicado en la tabla se refiere al peso de cada pieza singularmente considerada. Para calcular el peso total del material embalado se deberá agregar al peso según la tabla, el peso del embalaje y del palet (peso variable entre 10 y 30 kg en función de la cantidad y tipo de las PIEZAS ESPECIALES requeridas).

Указанный в таблице вес СПЕЦИАЛЬНЫХ ИЗДЕЛИЙ 20 мм - это вес каждого отдельного изделия. Для расчета общего веса упакованного материала необходимо добавить к указанному в таблице значению вес упаковки и поддона (вес может составлять от 10 до 30 кг, в зависимости от количества и типа заказанных СПЕЦИАЛЬНЫХ ИЗДЕЛИЙ)



**Costa toro.**  
Bullnose edge.  
Bord boudin.  
Abgerundete Kante.  
Canto redondo  
Закругленная кромка



**Costa retta.**  
Straight edge.  
Bord droit.  
Gerade Kante.  
Canto recto  
Прямоугольная кромка

**ATTENZIONE:** Per particolari installazioni potrebbero essere necessari articoli ed accessori specifici non presenti in questo catalogo. Per queste esigenze prego riferirsi direttamente al referente commerciale La Fabbrica.

N.B. Particular items and accessories not listed in this catalogue may be required for certain laying methods. For these needs, please contact the La Fabbrica sales sales directly.

ATTENTION: Pour les installations particulières, certains articles et accessoires particuliers qui ne sont pas indiqués dans ce catalogue pourraient être nécessaires. Dans ces cas-là, nous vous prions de vous référer directement à la référence commerciale La Fabbrica.

ACHTUNG: Für besondere Installationen können besondere Artikel oder Sonderzubehör notwendig sein, die nicht im vorliegenden Katalog aufgeführt sind. Wenden Sie sich bitte in diesen Fällen direkt an den Vertrieb von La Fabbrica.

ATENCIÓN: para instalaciones particulares podrían requerirse artículos y accesorios específicos que no están presentes en este catálogo. Para tales casos rogamos contactar directamente al representante comercial de La Fabbrica.

ВНИМАНИЕ: Для особых применений могут быть необходимы специальные артикулы и аксессуары, не представленные в данном каталоге. По поводу этих вопросов просим вас обращаться непосредственно к менеджеру

коммерческого отдела компании La Fabbrica.



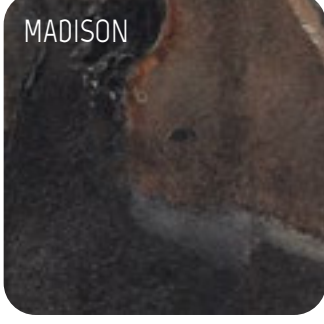

# HIGH LINE

Wall: Madison 10x30 (4"x12") Nat. Ret. / Floor: Madison 20x120 (8"x48") Nat. Ret.

GRES PORCELLANATO COLORATO IN MASSA . COLORED BODY PORCELAIN STONEWARE  
GRÈS CÉRAME COLORÉ DANS LA MASSE . EINGEFÄRBTES FEINSTEINZEUG  
GRES PORCELÁNICO COLOREADO EN MASA . КЕРАМОГРАНИТ ОКРАШЕННЫЙ В МАССЕ  
ISO 13006 - G - B1a (E ≤ 0,5%) - UNI EN 14411 - G

100% DESIGN  
AND PRODUCTION  
OF ITALY

V4  
SHADE SPECTRUM  
RANDOM

## INDOOR

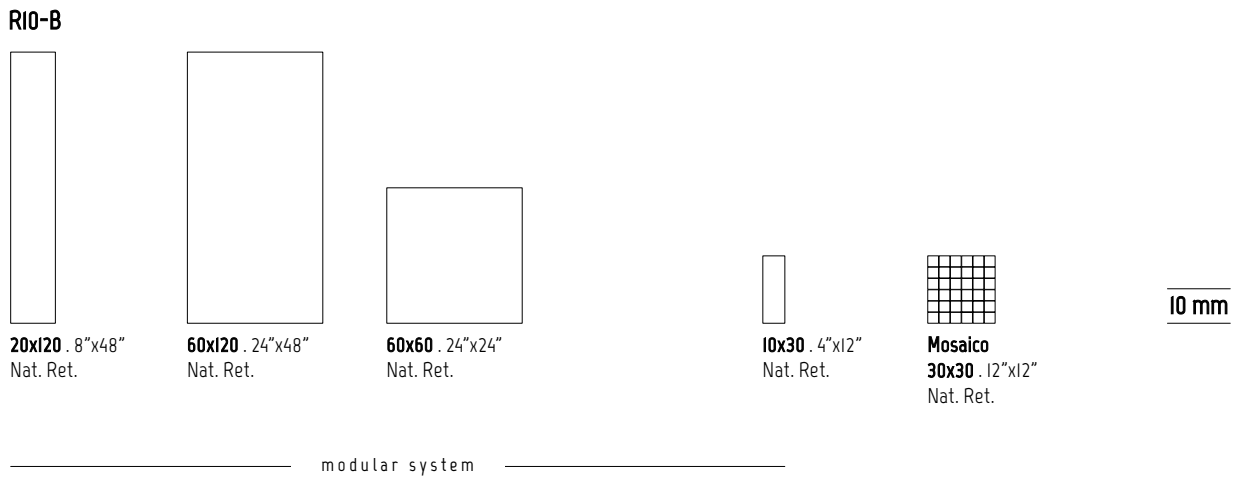

## OUTDOOR

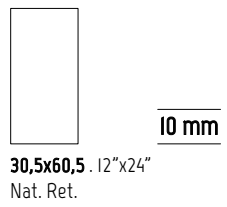

SVILUPPO GRAFICO PER FORMATO Pattern by size Développement graphique par format Grafischer Entwurf für Format Desarrollo gráfico por formato Варианты графики для каждого формата	60x120 10 mm	20x120 10 mm	60x60 10 mm	30x60 30,5x60,5 10 mm	10x30 10 mm
	19	57	45	63	378

# HIGH LINE

## ESSEX

INDOOR



**109026**  
20x120 . 8"x48"  
Nat. Ret.

**109027**  
20x120 . 8"x48"  
Lap. Ret.



**109006**  
60x120 . 24"x48"  
Nat. Ret.

**109007**  
60x120 . 24"x48"  
Lap. Ret.

10 mm R10-B



**109046**  
60x60 . 24"x24"  
Nat. Ret.

**109047**  
60x60 . 24"x24"  
Lap. Ret.



**109066**  
30x60 . 12"x24"  
Nat. Ret.



**109144**  
10x30 . 4"x12"  
Nat. Ret.



**109086**  
Mosaico  
30x30 . 12"x12"  
Nat. Ret.

**109087**  
Mosaico  
30x30 . 12"x12"  
Lap. Ret.



**109065**  
30,5x60,5 . 12"x24"  
Nat.

10 mm R11-C

modular system

## BROADWAY

INDOOR



**109021**  
20x120 . 8"x48"  
Nat. Ret.

**109022**  
20x120 . 8"x48"  
Lap. Ret.



**109001**  
60x120 . 24"x48"  
Nat. Ret.

**109002**  
60x120 . 24"x48"  
Lap. Ret.

10 mm R10-B



**109041**  
60x60 . 24"x24"  
Nat. Ret.

**109042**  
60x60 . 24"x24"  
Lap. Ret.



**109061**  
30x60 . 12"x24"  
Nat. Ret.



**109140**  
10x30 . 4"x12"  
Nat. Ret.

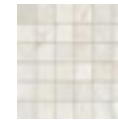

**109081**  
Mosaico  
30x30 . 12"x12"  
Nat. Ret.

**109082**  
Mosaico  
30x30 . 12"x12"  
Lap. Ret.



**109060**  
30,5x60,5 . 12"x24"  
Nat.

10 mm R11-C

modular system

## CHELSEA

INDOOR



**109023**  
20x120 . 8"x48"  
Nat. Ret.

**109024**  
20x120 . 8"x48"  
Lap. Ret.



**109003**  
60x120 . 24"x48"  
Nat. Ret.

**109004**  
60x120 . 24"x48"  
Lap. Ret.

10 mm R10-B

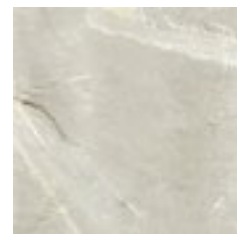

**109043**  
60x60 . 24"x24"  
Nat. Ret.

**109044**  
60x60 . 24"x24"  
Lap. Ret.



**109063**  
30x60 . 12"x24"  
Nat. Ret.



**109142**  
10x30 . 4"x12"  
Nat. Ret.



**109083**  
Mosaico  
30x30 . 12"x12"  
Nat. Ret.

**109084**  
Mosaico  
30x30 . 12"x12"  
Lap. Ret.

modular system

## LIBERTY

INDOOR



**109029**  
20x120 . 8"x48"  
Nat. Ret.

**109030**  
20x120 . 8"x48"  
Lap. Ret.



**109009**  
60x120 . 24"x48"  
Nat. Ret.

**109010**  
60x120 . 24"x48"  
Lap. Ret.

10 mm R10-B

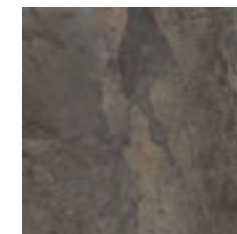

**109049**  
60x60 . 24"x24"  
Nat. Ret.

**109050**  
60x60 . 24"x24"  
Lap. Ret.



**109069**  
30x60 . 12"x24"  
Nat. Ret.



**109146**  
10x30 . 4"x12"  
Nat. Ret.

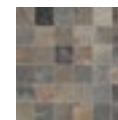

**109089**  
Mosaico  
30x30 . 12"x12"  
Nat. Ret.

**109090**  
Mosaico  
30x30 . 12"x12"  
Lap. Ret.

modular system

# HIGH LINE

## MADISON

INDOOR



**109032**  
20x120 . 8"x48"  
Nat. Ret.  
**109033**  
20x120 . 8"x48"  
Lap. Ret.



**109012**  
60x120 . 24"x48"  
Nat. Ret.  
**109013**  
60x120 . 24"x48"  
Lap. Ret.

10 mm R10-B



**109052**  
60x60 . 24"x24"  
Nat. Ret.  
**109053**  
60x60 . 24"x24"  
Lap. Ret.



**109072**  
30x60 . 12"x24"  
Nat. Ret.



**109148**  
10x30 . 4"x12"  
Nat. Ret.



**109092**  
Mosaico  
30x30 . 12"x12"  
Nat. Ret.  
**109093**  
Mosaico  
30x30 . 12"x12"  
Lap. Ret.



10 mm R11-C

**109071**  
30,5x60,5 . 12"x24"  
Nat.

modular system



Floor  
Essex 30x60 (12"x24") Nat. Ret.

# HIGH LINE

10 mm R10-B

Solo superficie naturale  
Only natural surface

ANSI A - 137.1: 2012  
WET DYNAMIC COEFFICIENT OF FRICTION

DCOF ≥ 0,42

	modular system												Battiscopa Skirting				Gradino costa retta Straight-edge step **				Gradino costa retta - Angolo SX / DX Straight-edge step - LH/RH corner **			
	20x120* 8"x48" Nat. Ret.	20x120 8"x48" Lap. Ret.	60x120* 24"x48" Nat. Ret.	60x120 24"x48" Lap. Ret.	60x60 24"x24" Nat. Ret.	60x60 24"x24" Lap. Ret.	30x60 12"x24" Nat. Ret.	10x30 4"x12" Nat. Ret.	30x30 12"x12" Nat. Ret.	30x30 12"x12" Lap. Ret.	30,5x60,5 12"x24" Nat.	10 mm R11-C	6,5x120 2 1/2"x48" Nat. Ret.	6,5x120 2 1/2"x48" Lap. Ret.	9,5x60 3 3/4"x24" Nat. Ret.	9,5x60 3 3/4"x24" Lap. Ret.	33x120x3,2h 13"x48"x1 1/4" h Nat. Ret.	33x120x3,2h 13"x48"x1 1/4" h Lap. Ret.	33x60x3,2h 13"x24"x1 1/4" h Nat. Ret.	33x60x3,2h 13"x24"x1 1/4" h Lap. Ret.	33x120x3,2h 13"x48"x1 1/4" h Nat. Ret.	33x120x3,2h 13"x48"x1 1/4" h Lap. Ret.	33x60x3,2h 13"x24"x1 1/4" h Nat. Ret.	33x60x3,2h 13"x24"x1 1/4" h Lap. Ret.
ESSEX	109026	109027	109006	109007	109046	109047	109066	109144	109086	109087	109065		109126	109124	109136	109135	109210	109204	109237	109240	109223 SX 109218 DX	109232 SX 109227 DX	109249 SX 109245 DX	109258 SX 109253 DX
CHELSEA	109023	109024	109003	109004	109043	109044	109063	109142	109083	109084	-		109123	109122	109134	109133	109209	109213	109236	109239	109222 SX 109217 DX	109231 SX 109226 DX	109248 SX 109244 DX	109257 SX 109252 DX
BROADWAY	109021	109022	109001	109002	109041	109042	109061	109140	109081	109082	109060		109121	109120	109132	109131	109208	109212	109235	109238	109221 SX 109216 DX	109230 SX 109225 DX	109247 SX 109243 DX	109256 SX 109251 DX
LIBERTY	109029	109030	109009	109010	109049	109050	109069	109146	109089	109090	-		109128	109127	109138	109137	109211	109214	109205	109241	109224 SX 109219 DX	109233 SX 109228 DX	109250 SX 109246 DX	109259 SX 109254 DX
MADISON	109032	109033	109012	109013	109052	109053	109072	109148	109092	109093	109071		109130	109129	109150	109151	109201	109215	109202	109242	109206 SX 109220 DX	109234 SX 109229 DX	109207 SX 109203 DX	109260 SX 109255 DX
PREZZO PRICE	€ 48,00 m <sup>2</sup>	€ 62,00 m <sup>2</sup>	€ 46,00 m <sup>2</sup>	€ 58,00 m <sup>2</sup>	€ 36,00 m <sup>2</sup>	€ 48,00 m <sup>2</sup>	€ 36,00 m <sup>2</sup>	€ 56,00 m <sup>2</sup>	€ 92,00 m <sup>2</sup>	€ 120,00 m <sup>2</sup>	€ 28,00 m <sup>2</sup>		€ 8,00 PZ/PCE	€ 9,00 PZ/PCE	€ 5,00 PZ/PCE	€ 6,00 PZ/PCE	€ 140,00 PZ/PCE	€ 148,00 PZ/PCE	€ 74,00 PZ/PCE	€ 76,00 PZ/PCE	€ 164,00 PZ/PCE	€ 164,00 PZ/PCE	€ 102,00 PZ/PCE	€ 102,00 PZ/PCE
CODICE PREZZO PRICE CODE	M113	M129	M109	M125	M089	M113	M089	M123	M159	M187	M073		P029	P033	P017	P021	P207	P215	P141	P143	P231	P231	P169	P169
	Epal 80x120	Epal 80x120	Epal 80x120	Epal 80x120	Epal 80x120	Epal 80x120	Epal 80x120	Epal 80x120	Epal 80x120	Epal 80x120	Epal 80x120		Epal 80x120	Epal 80x120	Epal 80x120	Epal 80x120	Epal 80x120	Epal 80x120	Epal 80x120	Epal 80x120	Epal 80x120	Epal 80x120	Epal 80x120	Epal 80x120
IMBALLO cm h. PACKING cm h.	55	55	75	75	75	75	75	81	75	75	76		-	-	-	-	-	-	-	-	-	-	-	-
	4	6	2	2	3	3	6	19	6	6	6		6	6	12	12	2	2	4	4	1	1	2	2
m <sup>2</sup> x	0,96	1,44	1,44	1,44	1,08	1,08	1,08	0,57	0,54	0,54	1,08		-	-	-	-	-	-	-	-	-	-	-	-
Kg x	21,22	31,82	32,40	32,40	24,75	25,27	24,08	12,70	12,69	12,69	33,00		11,04	11,04	15,00	15,00	23,00	23,00	20,00	20,00	12,00	12,00	11,00	11,00
x	48	24	32	30	40	40	40	72	54	54	48		-	-	-	-	-	-	-	-	-	-	-	-
m <sup>2</sup> x	46,08	34,56	46,08	43,20	43,20	43,20	43,20	41,04	29,16	29,16	53,28		-	-	-	-	-	-	-	-	-	-	-	-
Kg x	1.038	783	1.057	992	1.010	1.031	984	935	705	705	1604		-	-	-	-	-	-	-	-	-	-	-	-

\* NUOVA PALLETIZZAZIONE DISPONIBILE (AD ESAURIMENTO DELLO STOCK ESISTENTE).  
New pallet configuration (once current stock fully exhausted).  
Nouvelle palettisation disponible (jusqu'à épuisement du stock existant).  
Neue Palettierung verfügbar (solange der Vorrat reicht).  
Nueva paletización disponible (al agotarse las actuales existencias).  
Новые поддоны будут доступны (после расхования существующих запасов).

\*\* A DISPOSIZIONE SOLO SU RICHIESTA. TEMPI DI CONSEGNA: 30GG.  
Available upon request only. Delivery terms: 30 days.  
Disponible seulement sur requête. Délais de livraison: 30 jours.  
Verfügbar auf Anfrage. Lieferzeit: 30 Tage.  
Disponibile sólo bajo pedido. Plazo de entrega: 30 días.  
Изготавливается только по специальной заявке. Срок поставки: 30 дней.

PER IL GRADINO NON SI GARANTISCE LA STESSA TONALITÀ DEL FONDO.  
We cannot guarantee that the shade of the stair tile will be the same as the background tile.  
Pour la marche, nous ne garantissons pas la même tonalité du fond.  
Für die Stufe wird nicht der gleiche Farbton der Grundfliese garantiert.  
Para el peldaño no se garantiza el mismo tono del fondo.  
Для ступени не гарантирована одинаковость тона с фоном.



Wall: Trevi 60x120 (24"x48") Nat. Ret. - Alabastrino 120x120 (48"x48") Nat. Ret. / Floor: Alabastrino 120x120 (48"x48") Nat. Ret.

GRES PORCELLANATO COLORATO IN MASSA . COLORED BODY PORCELAIN STONEWARE  
 GRÈS CÉRAME COLORÉ DANS LA MASSE . EINGEFÄRBTES FEINSTEINZEUG  
 GRES PORCELÁNICO COLOREADO EN MASA . КЕРАМОГРАНИТ ОКРАШЕННЫЙ В МАССЕ  
 ISO 13006 - G - B1a (E ≤ 0,5%) - UNI EN 14411 - G

100% DESIGN  
AND PRODUCTION  
OF ITALY

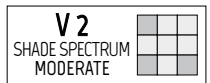

INDOOR

R10-B (naturale)

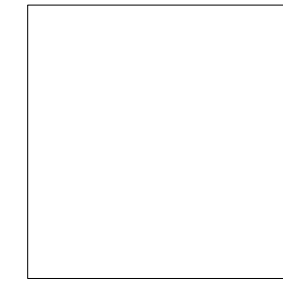

**120x120** . 48"x48"  
 Nat. Ret.  
**120x120** . 48"x48"  
 Lap. Ret.



**60x120** . 24"x48"  
 Nat. Ret.  
**60x120** . 24"x48"  
 Lap. Ret.

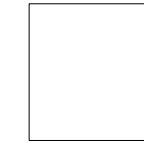

**60x60** . 24"x24"  
 Nat. Ret.  
**60x60** . 24"x24"  
 Lap. Ret.

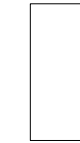

**30x60** . 12"x24"  
 Nat. Ret.  
**30x60** . 12"x24"  
 Lap. Ret.



**10x30** . 4"x12"  
 Nat. Ret.  
**10x30** . 4"x12"  
 Lap. Ret.

**8,8 mm**

modular system



**Esagona**  
**28x29** . 11"x11 1/2"  
 Nat. Ret.



**Muretto**  
**30x30** . 12"x12"  
 Nat. Ret.



**Intreccio**  
**30x30** . 12"x12"  
 Nat. Ret.



**Spina di pesce**  
**30,5x30,5** . 12"x12"  
 Nat. Ret.



**Mosaico**  
**30x30** . 12"x12"  
 Nat. Ret.

**8,8 mm**

SVILUPPO GRAFICO PER FORMATO  
 Different patterns (based on size)  
 Différents graphismes par format  
 Je nach Format verschiedene Grafiken  
 Gráficas diferentes según formato  
 Кол. Вариантов графики для каждого формата

120x120	60x120	60x60	30x60	10x30
8,8 mm	8,8 mm	8,8 mm	8,8 mm	8,8 mm
10	15	30	53	318

# IMPERIAL

8,8 mm RIO-B (naturale)



Wall  
Navona 60x120 (24"x48") Nat. Ret.  
Decoro Esagona Navona 28x29 (11"x11 1/2") Nat. Ret.

Floor  
Navona 60x120 (24"x48") Nat. Ret.  
60x60 (24"x24") Nat. Ret.

# IMPERIAL

8,8 mm RIO-B (naturale)



Wall  
Decoro Mosaico Alabastrino 30x30 (12"x12") Nat. Ret.  
Decoro Muretto Alabastrino 30x30 (12"x12") Nat. Ret.

Floor  
Alabastrino 120x120 (48"x48") Nat. Ret.  
Decoro Mosaico Alabastrino 30x30 (12"x12") Nat. Ret.

Floor  
Tivoli 60x120 (24"x48") Nat. Ret.  
Backsplash Tivoli 10x30 (4"x12") Nat. Ret.

# IMPERIAL

## ALABASTRINO

INDOOR



**I55041**  
120x120 . 48"x48"  
Nat. Ret.  
**I55045**  
120x120 . 48"x48"  
Lap. Ret.



**I55001**  
60x120 . 24"x48"  
Nat. Ret.  
**I55005**  
60x120 . 24"x48"  
Lap. Ret.

**8,8 mm** RIO-B (naturale)



**I55011**  
60x60 . 24"x24"  
Nat. Ret.  
**I55015**  
60x60 . 24"x24"  
Lap. Ret.



**I55021**  
30x60 . 12"x24"  
Nat. Ret.  
**I55025**  
30x60 . 12"x24"  
Lap. Ret.



**I55031**  
10x30 . 4"x12"  
Nat. Ret.  
**I55035**  
10x30 . 4"x12"  
Lap. Ret.

modular system



**I55321**  
Esagona  
28x29 . 11"x11 1/2"  
Nat. Ret.



**I55341**  
Muretto  
30x30 . 12"x12"  
Nat. Ret.



**I55311**  
Intreccio  
30x30 . 12"x12"  
Nat. Ret.



**I55301**  
Spina di pesce  
30,5x30,5 . 12"x12"  
Nat. Ret.

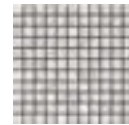

**I55331**  
Mosaico  
30x30 . 12"x12"  
Nat. Ret.

**8,8 mm**

## TREVI

INDOOR



**I55042**  
120x120 . 48"x48"  
Nat. Ret.  
**I55046**  
120x120 . 48"x48"  
Lap. Ret.



**I55002**  
60x120 . 24"x48"  
Nat. Ret.  
**I55006**  
60x120 . 24"x48"  
Lap. Ret.

**8,8 mm** RIO-B (naturale)



**I55012**  
60x60 . 24"x24"  
Nat. Ret.  
**I55016**  
60x60 . 24"x24"  
Lap. Ret.

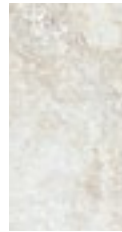

**I55022**  
30x60 . 12"x24"  
Nat. Ret.  
**I55026**  
30x60 . 12"x24"  
Lap. Ret.



**I55032**  
10x30 . 4"x12"  
Nat. Ret.  
**I55036**  
10x30 . 4"x12"  
Lap. Ret.

modular system



**I55322**  
Esagona  
28x29 . 11"x11 1/2"  
Nat. Ret.



**I55342**  
Muretto  
30x30 . 12"x12"  
Nat. Ret.



**I55312**  
Intreccio  
30x30 . 12"x12"  
Nat. Ret.



**I55302**  
Spina di pesce  
30,5x30,5 . 12"x12"  
Nat. Ret.



**I55332**  
Mosaico  
30x30 . 12"x12"  
Nat. Ret.

**8,8 mm**



# IMPERIAL

## NAVONA

INDOOR



**I55043**  
120x120 . 48"x48"  
Nat. Ret.

**I55047**  
120x120 . 48"x48"  
Lap. Ret.



**I55003**  
60x120 . 24"x48"  
Nat. Ret.

**I55007**  
60x120 . 24"x48"  
Lap. Ret.

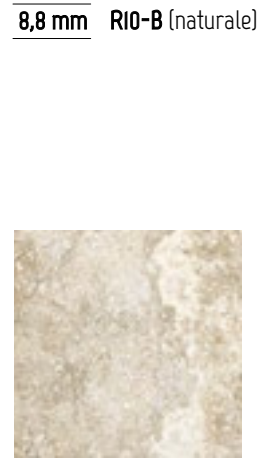

**I55013**  
60x60 . 24"x24"  
Nat. Ret.

**I55017**  
60x60 . 24"x24"  
Lap. Ret.



**I55023**  
30x60 . 12"x24"  
Nat. Ret.

**I55027**  
30x60 . 12"x24"  
Lap. Ret.



**I55033**  
10x30 . 4"x12"  
Nat. Ret.

**I55037**  
10x30 . 4"x12"  
Lap. Ret.

**8,8 mm** R10-B (naturale)

modular system



**I55323**  
Esagona  
28x29 . 11"x11 1/2"  
Nat. Ret.



**I55343**  
Muretto  
30x30 . 12"x12"  
Nat. Ret.



**I55303**  
Spina di pesce  
30,5x30,5 . 12"x12"  
Nat. Ret.



**I55333**  
Mosaico  
30x30 . 12"x12"  
Nat. Ret.

**8,8 mm**

## TIVOLI

INDOOR



**I55044**  
120x120 . 48"x48"  
Nat. Ret.

**I55048**  
120x120 . 48"x48"  
Lap. Ret.



**I55004**  
60x120 . 24"x48"  
Nat. Ret.

**I55008**  
60x120 . 24"x48"  
Lap. Ret.



**I55014**  
60x60 . 24"x24"  
Nat. Ret.

**I55018**  
60x60 . 24"x24"  
Lap. Ret.



**I55024**  
30x60 . 12"x24"  
Nat. Ret.

**I55028**  
30x60 . 12"x24"  
Lap. Ret.



**I55034**  
10x30 . 4"x12"  
Nat. Ret.

**I55038**  
10x30 . 4"x12"  
Lap. Ret.

**8,8 mm** R10-B (naturale)

modular system



**I55324**  
Esagona  
28x29 . 11"x11 1/2"  
Nat. Ret.



**I55344**  
Muretto  
30x30 . 12"x12"  
Nat. Ret.



**I55314**  
Intreccio  
30x30 . 12"x12"  
Nat. Ret.



**I55304**  
Spina di pesce  
30,5x30,5 . 12"x12"  
Nat. Ret.



**I55334**  
Mosaico  
30x30 . 12"x12"  
Nat. Ret.

**8,8 mm**

# IMPERIAL

8,8 mm RIO-B (naturale)

modular system

Solo superficie naturale  
Only natural surface

ANSI A - I37.1: 2012  
WET DYNAMIC COEFFICIENT OF FRICTION  
DCOF ≥ 0,42

	modular system										Decoro Esagona Esagona decorative tile	Muretto Brick-effect mosaic	Intreccio Weave	Decoro Spina di pesce Spina di pesce decorative tile	Mosaico Mosaic	Battiscopa Skirting	Gradino costa retta Straight-edge step **	Gradino costa retta - Angolo SX / DX Straight-edge step - LH/RH corner **		
	120x120 48"x48" Nat. Ret.	120x120 48"x48" Lap. Ret.	60x120 24"x48" Nat. Ret.	60x120 24"x48" Lap. Ret.	60x60 24"x24" Nat. Ret.	60x60 24"x24" Lap. Ret.	30x60 12"x24" Nat. Ret.	30x60 12"x24" Lap. Ret.	10x30 4"x12" Nat. Ret.	10x30 4"x12" Lap. Ret.	28x29 11"x11 1/2" Nat. Ret.	30x30 12"x12" Nat. Ret.	30x30 12"x12" Nat. Ret.	30,5x30,5 12"x12" Nat. Ret.	30x30 12"x12" Nat. Ret.	7x60 3"x24" Nat. Ret.	33x120x3,2h 13"x48"x1 1/4" Nat. Ret.	33x120x3,2h 13"x48"x1 1/4" Lap. Ret.	33x120x3,2h 13"x48"x1 1/4" Nat. Ret.	33x120x3,2h 13"x48"x1 1/4" Lap. Ret.
ALABASTRINO	I55041	I55045	I55001	I55005	I55011	I55015	I55021	I55025	I55031	I55035	I55321	I55341	I55311	I55301	I55331	I55111	I55201	I55205	I55221 SX I55211 DX	I55225 SX I55215 DX
TREVI	I55042	I55046	I55002	I55006	I55012	I55016	I55022	I55026	I55032	I55036	I55322	I55342	I55312	I55302	I55332	I55112	I55202	I55206	I55222 SX I55212 DX	I55226 SX I55216 DX
NAVONA	I55043	I55047	I55003	I55007	I55013	I55017	I55023	I55027	I55033	I55037	I55323	I55343	-	I55303	I55333	I55113	I55203	I55207	I55223 SX I55213 DX	I55227 SX I55217 DX
TIVOLI	I55044	I55048	I55004	I55008	I55014	I55018	I55024	I55028	I55034	I55038	I55324	I55344	I55314	I55304	I55334	I55114	I55204	I55208	I55224 SX I55214 DX	I55228 SX I55218 DX
PREZZO PRICE	€ 54,00 m <sup>2</sup>	€ 64,00 m <sup>2</sup>	€ 46,00 m <sup>2</sup>	€ 54,00 m <sup>2</sup>	€ 38,00 m <sup>2</sup>	€ 50,00 m <sup>2</sup>	€ 34,00 m <sup>2</sup>	€ 50,00 m <sup>2</sup>	€ 56,00 m <sup>2</sup>	€ 72,00 m <sup>2</sup>	€ 272,00 m <sup>2</sup>	€ 148,00 m <sup>2</sup>	€ 144,00 m <sup>2</sup>	€ 132,00 m <sup>2</sup>	€ 126,00 m <sup>2</sup>	€ 5,00 PZ/PCE	€ 140,00 PZ/PCE	€ 148,00 PZ/PCE	€ 164,00 PZ/PCE	€ 176,00 PZ/PCE
CODICE PREZZO PRICE CODE	M121	M131	M109	M121	M093	M117	M085	M117	M123	M139	M303	M215	M211	M199	M193	P017	P207	P215	P231	P243
	<b>Epal</b> 143x123		<b>Epal</b> 80x120	<b>Epal</b> 80x120	<b>Epal</b> 80x120		<b>Epal</b> 80x120		<b>Epal</b> 80x120		<b>Epal</b> 80x120	<b>Epal</b> 80x120	<b>Epal</b> 80x120	<b>Epal</b> 80x120	<b>Epal</b> 80x120	<b>Epal</b> 80x120	<b>Epal</b> 80x120	<b>Epal</b> 80x120	<b>Epal</b> 80x120	<b>Epal</b> 80x120
IMBALLO cm h. PACKING cm h.	75		75	75	75		75		81		-	-	-	-	-	-	-	-	-	-
x	1		2	2	3		6		19		6	6	6	6	6	15	2			1
m <sup>2</sup> x	1,44		1,44	1,44	1,08		1,08		0,57		0,48	0,54	0,54	0,55	0,54	0,63	-			-
Kg x	28,8		29,82	29,82	22,84		22,64		11,43		9,41	10,36	10,36	10,74	10,36	13,28	20,70			10,80
x	40		32	30	40		48		72		60	60	60	60	60	-	-			-
m <sup>2</sup> x	57,6		46,08	43,20	43,20		51,84		41,04		28,80	32,40	32,40	33	32,40	-	-			-
Kg x	1.152		974	895	934		1.107		843		584,60	641,60	641,60	664,40	641,60	-	-			-

\*\* A DISPOSIZIONE SOLO SU RICHIESTA. TEMPI DI CONSEGNA: 30GG.

Available upon request only. Delivery terms: 30 days.

Disponible seulement sur requête. Délais de livraison: 30 jours.

Verfügbar auf Anfrage. Lieferzeit: 30 Tage.

Disponible sólo bajo pedido. Plazo de entrega: 30 días.

Изготавливается только по специальной заявке. Срок поставки: 30 дней.

PER IL GRADINO NON SI GARANTISCE LA STESSA TONALITÀ DEL FONDO.

We cannot guarantee that the shade of the stair tile will be the same as the background tile.

Pour la marche, nous ne garantissons pas la même tonalité du fond.

Für die Stufe wird nicht der gleiche Farbton der Grundfliese garantiert.

Para el peldaño no se garantiza el mismo tono del fondo.

Для ступени не гарантирована одинаковость тона с фоном.



Floor: Madera 60x60 (24"x24") Nat. Ret

GRES PORCELLANATO COLORATO IN MASSA . COLORED BODY PORCELAIN STONEWARE  
GRÈS CÉRAME COLORÉ DANS LA MASSE . EINGEFÄRBTES FEINSTEINZEUG  
GRES PORCELÁNICO COLOREADO EN MASA . КЕРАМОГРАНИТ ОКРАШЕННЫЙ В МАССЕ  
ISO 13006 - G - B1a (E ≤ 0,5%) - UNI EN 14411 - G

100% DESIGN  
AND PRODUCTION  
OF ITALY

**V2**  
SHADE SPECTRUM  
MODERATE

**V3**  
SHADE SPECTRUM  
HIGH

ANTRACITE

DIASPRO / MADERA / PRASIO

### INDOOR

R10-A

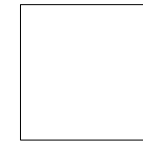

60x60 . 24"x24"  
Nat. Ret.



30x60 . 12"x24"  
Nat. Ret.  
30,5x60,5 . 12"x24"  
Nat.



30x30 . 12"x12"  
Nat. Ret.



Mosaico  
30x30 . 12"x12"  
Nat. Ret.

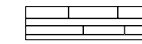

Muretto  
15x60 . 6"x24"  
Nat. Ret.

10 mm

modular system

### OUTDOOR

R11-C

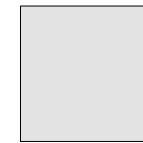

60x60 . 24"x24"  
Nat. Ret.



30x60 . 12"x24"  
Nat. Ret.  
30,5x60,5 . 12"x24"  
Nat.



30x30 . 12"x12"  
Nat. Ret.

10 mm

modular system

R11-C



60x60 . 24"x24"  
Nat. Ret.

20 mm

SVILUPPO GRAFICO PER FORMATO  
Pattern by size  
Développement graphique par format  
Grafischer Entwurf für Format  
Desarrollo gráfico por formato  
Варианты графики для каждого формата

60x60  
10 mm

30x60  
10 mm

30,5x60,5  
10 mm

30x30  
10 mm

60x60  
10 mm  
20 mm

14

46

46

56

14

# I QUARZI

## ANTRACITE

INDOOR



10 mm R10-A

**662R14**  
60x60 . 24"x24"  
Nat. Ret.

**V62R14**  
30x60 . 12"x24"  
Nat. Ret.

**962R14**  
30x30 . 12"x12"  
Nat. Ret.

**V62N14**  
30,5x60,5 . 12"x24"  
Nat.

modular system



**962R19**  
Mosaico  
30x30 . 12"x12"  
(5x5) su rete  
Nat. Ret.

**L62R18**  
Muretto  
15x60 . 6"x24"  
Nat. Ret.

## PRASIO

INDOOR



10 mm R10-A

**662R13**  
60x60 . 24"x24"  
Nat. Ret.

**V62R13**  
30x60 . 12"x24"  
Nat. Ret.

**962R13**  
30x30 . 12"x12"  
Nat. Ret.

**V62N13**  
30,5x60,5 . 12"x24"  
Nat.

modular system



**962R18**  
Mosaico  
30x30 . 12"x12"  
(5x5) su rete  
Nat. Ret.

**L62R17**  
Muretto  
15x60 . 6"x24"  
Nat. Ret.

## DIASPRO

INDOOR



10 mm R10-A

**662R11**  
60x60 . 24"x24"  
Nat. Ret.

**V62R11**  
30x60 . 12"x24"  
Nat. Ret.

**962R11**  
30x30 . 12"x12"  
Nat. Ret.

**V62N11**  
30,5x60,5 . 12"x24"  
Nat.

modular system



**962R16**  
Mosaico  
30x30 . 12"x12"  
(5x5) su rete  
Nat. Ret.

**L62R15**  
Muretto  
15x60 . 6"x24"  
Nat. Ret.

## MADERA

INDOOR



10 mm R10-A

**662R12**  
60x60 . 24"x24"  
Nat. Ret.

**V62R12**  
30x60 . 12"x24"  
Nat. Ret.

**962R12**  
30x30 . 12"x12"  
Nat. Ret.

**V62N12**  
30,5x60,5 . 12"x24"  
Nat.

modular system



**962R17**  
Mosaico  
30x30 . 12"x12"  
(5x5) su rete  
Nat. Ret.

**L62R16**  
Muretto  
15x60 . 6"x24"  
Nat. Ret.

OUTDOOR



10 mm R11-C

**662RE4**  
60x60 . 24"x24"  
Nat. Ret.

**V62RE4**  
30x60 . 12"x24"  
Nat. Ret.

**962RE4**  
30x30 . 12"x12"  
Nat. Ret.

**V62NE4**  
30,5x60,5 . 12"x24"  
Nat.

modular system



20 mm R11-C

**662RE8**  
60x60 . 24"x24"  
Nat. Ret.

OUTDOOR



10 mm R11-C

**662RE3**  
60x60 . 24"x24"  
Nat. Ret.

**V62RE3**  
30x60 . 12"x24"  
Nat. Ret.

**962RE3**  
30x30 . 12"x12"  
Nat. Ret.

**V62NE3**  
30,5x60,5 . 12"x24"  
Nat.

modular system



20 mm R11-C

**662RE7**  
60x60 . 24"x24"  
Nat. Ret.

OUTDOOR



10 mm R11-C

**662RE1**  
60x60 . 24"x24"  
Nat. Ret.

**V62RE1**  
30x60 . 12"x24"  
Nat. Ret.

**962RE1**  
30x30 . 12"x12"  
Nat. Ret.

**V62NE1**  
30,5x60,5 . 12"x24"  
Nat.

modular system



20 mm R11-C

**662RE5**  
60x60 . 24"x24"  
Nat. Ret.

OUTDOOR



10 mm R11-C

**662RE2**  
60x60 . 24"x24"  
Nat. Ret.

**V62RE2**  
30x60 . 12"x24"  
Nat. Ret.

**962RE2**  
30x30 . 12"x12"  
Nat. Ret.

**V62NE2**  
30,5x60,5 . 12"x24"  
Nat.

modular system

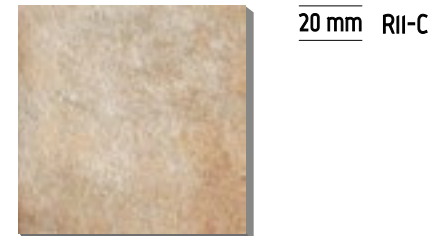













20 mm R11-C

**662RE6**  
60x60 . 24"x24"  
Nat. Ret.

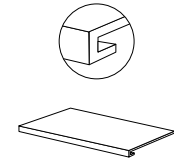
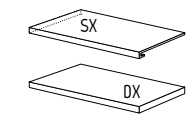
# I QUARZI

10 mm RIO-A

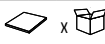
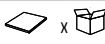
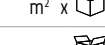
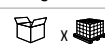
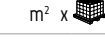
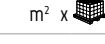
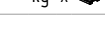
ANSI A - 137.1: 2012  
WET DYNAMIC COEFFICIENT OF FRICTION | DCOF ≥ 0,42

	modular system				Mosaico Mosaic	Muretto Brick-effect mosaic	Battiscopa Skirting	Gradino costa retta Straight-edge step **	Gradino costa retta - Angolo SX / DX Straight-edge step - LH/RH corner **
	 60x60 24"x24" Nat. Ret.	 30x60 12"x24" Nat. Ret.	 30,5x60,5 12"x24" Nat.	 30x30 12"x12" Nat. Ret.	 30x30 12"x12" Nat. Ret.	 15x60 6"x24" Nat.	 9,5x60 33 3/4"x24" Nat. Ret.	 33x60x3,2h 13"x24"x1 1/4"h Nat. Ret.	 33x60x3,2h 13"x24"x1 1/4"h Nat. Ret.
ANTRACITE 	662RI4	V62RI4	V62NI4	962RI4	962RI9	L62RI8	B62RI4	K62RI8	J62RS8 SX J62RD8 DX
PRASIO 	662RI3	V62RI3	V62NI3	962RI3	962RI8	L62RI7	B62RI3	K62RI7	J62RS7 SX J62RD7 DX
DIASPRO 	662RI1	V62RI1	V62NI1	962RI1	962RI6	L62RI5	B62RI1	K62RI5	J62RS5 SX J62RD5 DX
MADERA 	662RI2	V62RI2	V62NI2	962RI2	962RI7	L62RI6	B62RI2	K62RI6	J62RS6 SX J62RD6 DX
PREZZO PRICE	€ 36,00 m <sup>2</sup>	€ 36,00 m <sup>2</sup>	€ 28,00 m <sup>2</sup>	€ 47,00 m <sup>2</sup>	€ 92,00 m <sup>2</sup>	€ 118,00 m <sup>2</sup>	€ 5,00 PZ/PCE	€ 74,00 PZ/PCE	€ 102,00 PZ/PCE
CODICE PREZZO PRICE CODE	M089	M089	M073	M111	M159	M185	P017	P141	P169
	Epal 80x120	Epal 80x120	Epal 80x120	Epal 80x120	Epal 80x120	Epal 80x120	Epal 80x120	Epal 80x120	Epal 80x120
IMBALLO cm h. PACKING cm h.	75	75	76	75	75	70	-	-	-
 x 	3	6	6	12	6	3	12	4	4
m <sup>2</sup> x 	1,08	1,08	1,10	1,08	0,54	0,27	-	-	-
Kg x 	23,33	23,22	21,10	22,30	13,00	6,00	15,00	23,00	24,00
 x 	40	40	40	40	54	98	-	-	-
m <sup>2</sup> x 	43,20	43,20	44,00	43,20	29,16	26,46	-	-	-
Kg x 	948	949	859	912	720	610	-	-	-



Floor  
Prasio 60x60 (24"x24") Nat. Ret.  
Prasio 30x60 (12"x24") Nat. Ret.  
Prasio 30x30 (12"x12") Nat. Ret.

\*\* A DISPOSIZIONE SOLO SU RICHIESTA. TEMPI DI CONSEGNA: 30GG.  
Available upon request only. Delivery terms: 30 days.  
Disponible seulement sur requête. Délais de livraison: 30 jours.  
Verfügbar auf Anfrage. Lieferzeit: 30 Tage.  
Disponibile sólo bajo pedido. Plazo de entrega: 30 días.  
Изготавливается только по специальной заявке. Срок поставки: 30 дней.

PER IL GRADINO NON SI GARANTISCE LA STESSA TONALITÀ DEL FONDO.  
We cannot guarantee that the shade of the stair tile will be the same as the background tile.  
Pour la marche, nous ne garantissons pas la même tonalité du fond.  
Für die Stufe wird nicht der gleiche Farbton der Grundfliese garantiert.  
Para el peldaño no se garantiza el mismo tono del fondo.  
Для ступени не гарантирована одинаковость тона с фоном.

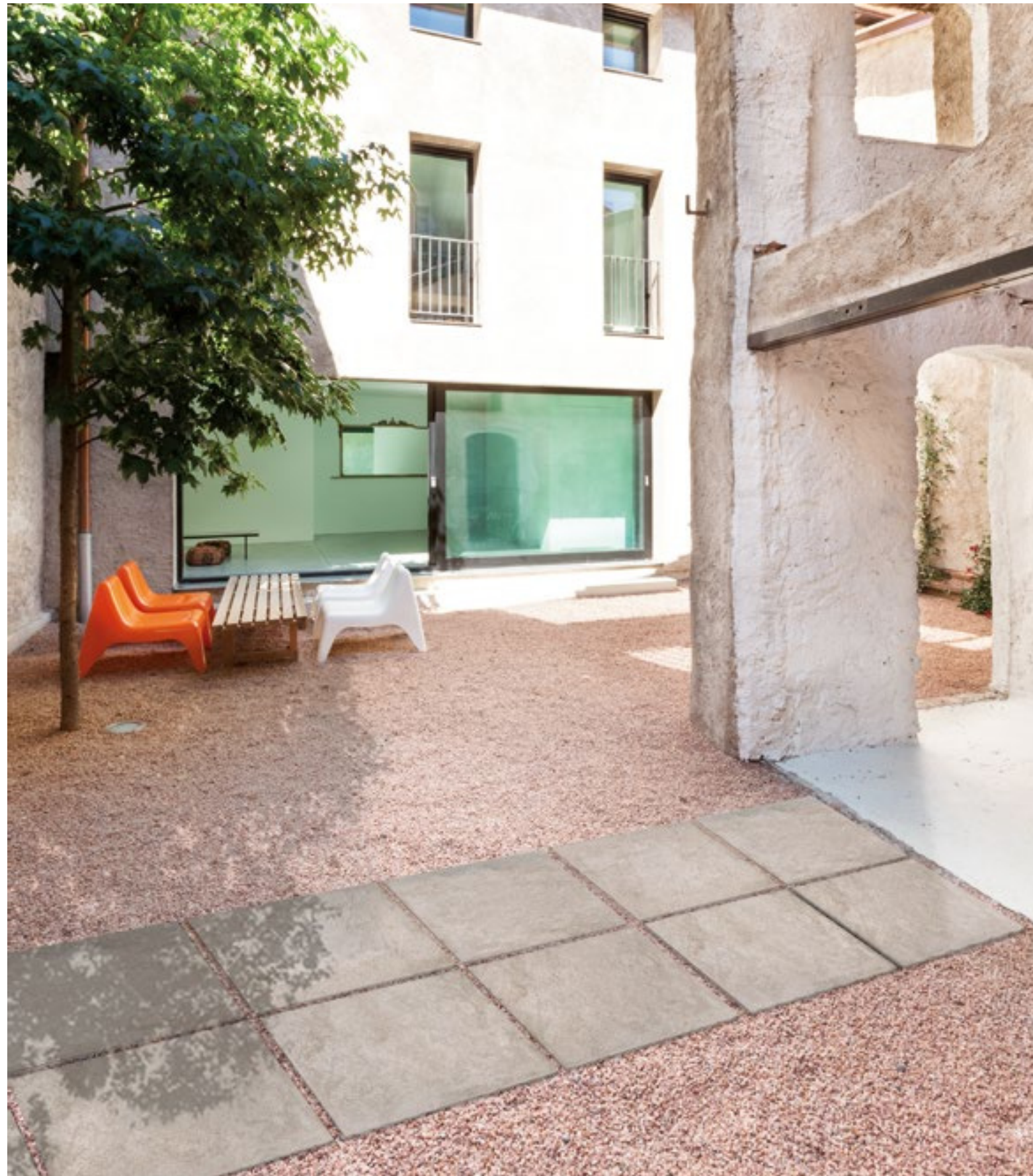

Floor  
Prasio 60x60 (24"x24") Nat. Ret. 20 mm RII

10 mm RII-C

ANSI A - 137.1: 2012  
WET DYNAMIC COEFFICIENT OF FRICTION | DCOF ≥ 0,42

	modular system					
	60x60 24"x24" Nat. Ret.	30x60 12"x24" Nat. Ret.	30,5x60,5 12"x24" Nat.	30x30 12"x12" Nat. Ret.	33x60x3,2h 13"x24"x1 1/4"h Nat. Ret.	33x60x3,2h 13"x24"x1 1/4"h Nat. Ret.
ANTRACITE	662RE4	V62RE4	V62NE4	962RE4	K62RE8	J62RE8S SX J62RE8D DX
PRASIO	662RE3	V62RE3	V62NE3	962RE3	K62RE7	J62RE7S SX J62RE7D DX
DIASPRO	662RE1	V62RE1	V62NE1	962RE1	K62RE5	J62RE5S SX J62RE5D DX
MADERA	662RE2	V62RE2	V62NE2	962RE2	K62RE6	J62RE6S SX J62RE6D DX
PREZZO PRICE	€ 36,00 m <sup>2</sup>	€ 36,00 m <sup>2</sup>	€ 28,00 m <sup>2</sup>	€ 47,00 m <sup>2</sup>	€ 74,00 PZ/PCE	€ 102,00 PZ/PCE
CODICE PREZZO PRICE CODE	M089	M089	M073	M111	PI4I	PI69
	<b>Pallet 80x120</b>	<b>Pallet 80x120</b>	<b>Pallet 80x120</b>	<b>Pallet 80x120</b>	<b>Pallet 80x120</b>	<b>Pallet 80x120</b>
IMBALLO cm h. PACKING cm h.	75	75	76	75	-	-
x	3	6	6	12	4	4
m <sup>2</sup> x	1,08	1,08	1,10	1,08	-	-
Kg x	23,33	23,22	21,10	22,30	23,00	24,00
x	40	40	40	40	-	-
m <sup>2</sup> x	43,20	43,20	44,00	43,20	-	-
Kg x	948	949	859	912	-	-

\*\* A DISPOSIZIONE SOLO SU RICHIESTA. TEMPI DI CONSEGNA: 30GG.  
Available upon request only. Delivery terms: 30 days.  
Disponible seulement sur requête. Délais de livraison: 30 jours.  
Verfügbar auf Anfrage. Lieferzeit: 30 Tage.  
Disponibile sólo bajo pedido. Plazo de entrega: 30 días.  
Изготавливается только по специальной заявке. Срок поставки: 30 дней.

PER IL GRADINO NON SI GARANTISCE LA STESSA TONALITÀ DEL FONDO.  
We cannot guarantee that the shade of the stair tile will be the same as the background tile.  
Pour la marche, nous ne garantissons pas la même tonalité du fond.  
Für die Stufe wird nicht der gleiche Farbton der Grundfliese garantiert.  
Para el peldaño no se garantiza el mismo tono del fondo.  
Для ступени не гарантирована одинаковость тона с фоном.

# I QUARZI

20 mm RII-C

ANSI A - 137.1: 2012  
WET DYNAMIC COEFFICIENT OF FRICTION | DCOF ≥ 0,42

	60x60 24"x24" Nat. Ret.	15x60 6"x24"	30x60 12"x24"	15x60 6"x24"	30x60 12"x24"	30x60 12"x24"	30x60 12"x24"	15x60 6"x24"	30x60 12"x24"	15x60 6"x24"	30x60 12"x24"	15x60 6"x24"	30x60 12"x24"	15x60 6"x24"	30x60 12"x24"		
ANTRACITE	662RE8	062246	062231	062256 SX 062251 DX	062241 SX 062236 DX	062181	062177	062199 SX 062190 DX	062195 SX 062186 DX	062127	062123	062154	062150	062145 SX 062136 DX	062141 SX 062132 DX	062172 SX 062163 DX	062168 SX 062159 DX
PRASIO	662RE7	062245	062230	062255 SX 062250 DX	062240 SX 062235 DX	062180	062176	062198 SX 062189 DX	062194 SX 062185 DX	062126	062122	062153	062149	062144 SX 062135 DX	062140 SX 062131 DX	062171 SX 062162 DX	062167 SX 062158 DX
DIASPRO	662RE5	062243	062228	062253 SX 062248 DX	062238 SX 062233 DX	062178	062174	062196 SX 062187 DX	062192 SX 062183 DX	062124	062120	062151	062147	062142 SX 062133 DX	062138 SX 062129 DX	062169 SX 062160 DX	062165 SX 062156 DX
MADERA	662RE6	062244	062229	062254 SX 062249 DX	062239 SX 062234 DX	062179	062175	062197 SX 062188 DX	062193 SX 062184 DX	062125	062121	062152	062148	062143 SX 062134 DX	062139 SX 062130 DX	062170 SX 062161 DX	062166 SX 062157 DX
PREZZO PRICE	€ 50,00 m <sup>2</sup>	€ 128,00 PZ/PCE	€ 150,00 PZ/PCE	€ 128,00 PZ/PCE	€ 150,00 PZ/PCE	€ 70,00 PZ/PCE	€ 60,00 PZ/PCE	€ 90,00 PZ/PCE	€ 78,00 PZ/PCE	€ 60,00 PZ/PCE	€ 50,00 PZ/PCE	€ 60,00 PZ/PCE	€ 50,00 PZ/PCE	€ 78,00 PZ/PCE	€ 70,00 PZ/PCE	€ 78,00 PZ/PCE	€ 70,00 PZ/PCE
CODICE PREZZO PRICE CODE	MII7	PI95	P217	PI95	P217	PI37	PI27	PI57	PI45	PI27	PII7	PI27	PII7	PI45	PI37	PI45	PI37
IMBALLO cm h. PACKING cm h.	Epal 80x120 75	Epal 80x120 -	Epal 80x120 -	Epal 80x120 -	Epal 80x120 -	Epal 80x120 -	Epal 80x120 -	Epal 80x120 -	Epal 80x120 -	Epal 80x120 -	Epal 80x120 -	Epal 80x120 -	Epal 80x120 -	Epal 80x120 -	Epal 80x120 -	Epal 80x120 -	Epal 80x120 -
	2	1	1	1	1	1	1	1	1	1	1	1	1	1	1	1	1
m <sup>2</sup> x	0,72	-	-	-	-	-	-	-	-	-	-	-	-	-	-	-	-
Kg x	31,00	4,20	8,40	3,60	7,20	9,00	6,60	4,50	9,00	4,50	9,00	4,50	9,00	3,80	6,60	3,80	6,60
m <sup>2</sup> x	21,60	-	-	-	-	-	-	-	-	-	-	-	-	-	-	-	-
Kg x	950	-	-	-	-	-	-	-	-	-	-	-	-	-	-	-	-

IL PESO DEI PEZZI SPECIALI 20 MM INDICATO IN TABELLA SI RIFERISCE AL PESO DEL SINGOLO PEZZO. PER CALCOLARE IL PESO COMPLESSIVO DEL MATERIALE IMBALLATO OCCORRERÀ AGGIUNGERE AL PESO IN TABELLA IL PESO DELL'IMBALLO E DELLA PALETTA (PESO VARIABILE DA 10 A 30 KG IN FUNZIONE DELLA QUANTITÀ E DELLA TIPOLOGIA DEI PEZZI SPECIALI RICHIESTI).

The weight of the 20 mm TRIMS stated in the table refers to the weight of each trim. To calculate the total weight of the packed material, you will need to add the combined weight of the packing materials and the pallet

(weight ranging from 10 to 30kg depending on the quantity and the type of the TRIMS required) to the weight stated in the table.

Le poids des PIÈCES SPECIALES 20 mm indique dans le tableau se réfère au poids individuel de chaque pièce. Pour calculer le poids total du matériel emballé, il faudra ajouter au poids indiqué dans le tableau le poids de l'emballage et de la palette

(poids variable de 10 à 30 kg en fonction de la quantité et du type de PIÈCES SPECIALES demandées).

Das in der Tabelle angegebene Gewicht der 20 mm-SONDERTEILE bezieht sich auf das Gewicht des Einzelteils. Zur Berechnung des Gesamtgewichts des verpackten Materials muss zum in der Tabelle aufgeführten Wert das Gewicht der Verpackung und der Palette (von 10 bis 30 kg variierend in Abhängigkeit von der Menge und Art der gewünschten SONDERTEILE) dazugerechnet werden.

El peso de las PIEZAS ESPECIALES 20 mm indicado en la tabla se refiere al peso de cada pieza singularmente considerada. Para calcular el peso total del material embalado se deberá agregar al peso según la tabla, el peso del embalaje y del palet (peso variable entre 10 y 30 kg en función de la cantidad y tipo de las PIEZAS ESPECIALES requeridas).

Указанный в таблице вес СПЕЦИАЛЬНЫХ ИЗДЕЛИЙ 20 мм - это вес каждого отдельного изделия. Для расчета общего веса упакованного материала необходимо добавить к указанному в таблице значению вес упаковки и поддона (вес может составлять от 10 до 30 кг, в зависимости от количества и типа заказанных СПЕЦИАЛЬНЫХ ИЗДЕЛИЙ)



**Costa toro.**  
Bullnose edge.  
Bord boudin.  
Abgerundete Kante.  
Canto redondo  
Закругленная кромка



**Costa retta.**  
Straight edge.  
Bord droit.  
Gerade Kante.  
Canto recto  
Прямоугольная кромка

**ATTENZIONE:** Per particolari installazioni potrebbero essere necessari articoli ed accessori specifici non presenti in questo catalogo. Per queste esigenze prego riferirsi direttamente al referente commerciale La Fabbrica.

N.B. Particular items and accessories not listed in this catalogue may be required for certain laying methods. For these needs, please contact the La Fabbrica sales directly.

ATTENTION : Pour les installations particulières, certains articles et accessoires particuliers qui ne sont pas indiqués dans ce catalogue pourraient être nécessaires. Dans ces cas-là, nous vous prions de vous référer directement à la référence commerciale La Fabbrica.

ACHTUNG: Für besondere Installationen können besondere Artikel oder Sonderzubehör notwendig sein, die nicht im vorliegenden Katalog aufgeführt sind. Wenden Sie sich bitte in diesen Fällen direkt an den Vertrieb von La Fabbrica.

ATENCIÓN: para instalaciones particulares podrían requerirse artículos y accesorios específicos que no están presentes en este catálogo. Para tales casos rogamos contactar directamente al representante comercial de La Fabbrica.

ВНИМАНИЕ: Для особых применений могут быть необходимы специальные артикулы и аксессуары, не представленные в данном каталоге. По поводу этих вопросов просим вас обращаться непосредственно к менеджеру коммерческого отдела компании La Fabbrica.

# I QUARZI

20 mm RII-C

ANSI A - 137.1: 2012  
WET DYNAMIC COEFFICIENT OF FRICTION | DCOF ≥ 0,42

	Gradone bordo svasato Large step with rounded border		Gradone bordo svasato - Angolo SX / DX Large step with rounded border - Corner SX / DX		Canalina Channel	Canalina - Angolo SX / DX Channel - Corner SX / DX	Cordolo U-Border	Cordolo - Angolo SX / DX U-Border - Corner SX / DX
	30x60 12"x24"		30x60 12"x24"		15x60x8 6"x24"x3"	15x60x8 6"x24"x3"	15x60x15h 6"x24"x6"h	15x60x15h 6"x24"x6"h
ANTRACITE	062208	062204	062226 SX 062217 DX	062222 SX 062213 DX	062063	062073 SX 062068 DX	062078	062088 SX 062083 DX
PRASIO	062207	062203	062225 SX 062216 DX	062221 SX 062212 DX	062062	062072 SX 062067 DX	062077	062087 SX 062082 DX
DIASPRO	062205	06201	062223 SX 06214 DX	062219 SX 062210 DX	062060	062070 SX 062065 DX	062075	062085 SX 062080 DX
MADERA	062206	06202	062224 SX 06215 DX	062220 SX 062211 DX	062061	062071 SX 062066 DX	062076	062086 SX 062081 DX
PREZZO PRICE	€ 130,00 PZ/PCE	€ 114,00 PZ/PCE	€ 152,00 PZ/PCE	€ 138,00 PZ/PCE	€ 90,00 PZ/PCE	€ 108,00 PZ/PCE	€ 110,00 PZ/PCE	€ 134,00 PZ/PCE
CODICE PREZZO PRICE CODE	P197	P181	P219	P205	P157	P175	P177	P201
IMBALLO cm h. PACKING cm h.	-	-	-	-	-	-	-	-
x	1	1	1	1	1	1	1	1
m <sup>2</sup> x	-	-	-	-	-	-	-	-
Kg x	9,00	6,60			8,00	7,00	13,50	11,80
x	-	-	-	-	-	-	-	-
m <sup>2</sup> x	-	-	-	-	-	-	-	-
Kg x	-	-	-	-	-	-	-	-

IL PESO DEI PEZZI SPECIALI 20 MM INDICATO IN TABELLA SI RIFERISCE AL PESO DEL SINGOLO PEZZO. PER CALCOLARE IL PESO COMPLESSIVO DEL MATERIALE IMBALLATO OCCORRERÀ AGGIUNGERE AL PESO IN TABELLA IL PESO DELL'IMBALLO E DELLA PALETTA (PESO VARIABILE DA 10 A 30 KG IN FUNZIONE DELLA QUANTITÀ E DELLA TIPOLOGIA DEI PEZZI SPECIALI RICHIESTI).

The weight of the 20 mm TRIMS stated in the table refers to the weight of each trim. To calculate the total weight of the packed material, you will need to add the combined weight of the packing materials and the pallet

(weight ranging from 10 to 30kg depending on the quantity and the type of the TRIMS required) to the weight stated in the table.

Le poids des PIÈCES SPECIALES 20 mm indique dans le tableau se réfère au poids individuel de chaque pièce. Pour calculer le poids total du matériel emballé, il faudra ajouter au poids indiqué dans le tableau le poids de l'emballage et de la palette

(poids variable de 10 à 30 kg en fonction de la quantité et du type de PIÈCES SPECIALES demandées).

Das in der Tabelle angegebene Gewicht der 20 mm-SONDERTEILE bezieht sich auf das Gewicht des Einzelteils. Zur Berechnung des Gesamtgewichts des verpackten Materials muss zum in der Tabelle aufgeführten Wert das Gewicht der Verpackung und der Palette (von 10 bis 30 kg variierend in Abhängigkeit von der Menge und Art der gewünschten SONDERTEILE) dazugerechnet werden.

El peso de las PIEZAS ESPECIALES 20 mm indicado en la tabla se refiere al peso de cada pieza singularmente considerada. Para calcular el peso total del material embalado se deberá agregar al peso según la tabla, el peso del embalaje y del palet (peso variable entre 10 y 30 kg en función de la cantidad y tipo de las PIEZAS ESPECIALES requeridas).

Указанный в таблице вес СПЕЦИАЛЬНЫХ ИЗДЕЛИЙ 20 мм - это вес каждого отдельного изделия. Для расчета общего веса упакованного материала необходимо добавить к указанному в таблице значению вес упаковки и поддона (вес может составлять от 10 до 30 кг, в зависимости от количества и типа заказанных СПЕЦИАЛЬНЫХ ИЗДЕЛИЙ)



**Costa toro.**  
Bullnose edge.  
Bord boudin.  
Abgerundete Kante.  
Canto redondo  
Закругленная кромка



**Costa retta.**  
Straight edge.  
Bord droit.  
Gerade Kante.  
Canto recto  
Прямоугольная кромка

**ATTENZIONE:** Per particolari installazioni potrebbero essere necessari articoli ed accessori specifici non presenti in questo catalogo. Per queste esigenze prego riferirsi direttamente al referente commerciale La Fabbrica.

N.B. Particular items and accessories not listed in this catalogue may be required for certain laying methods. For these needs, please contact the La Fabbrica sale sales directly.

ATTENTION: Pour les installations particulières, certains articles et accessoires particuliers qui ne sont pas indiqués dans ce catalogue pourraient être nécessaires. Dans ces cas-là, nous vous prions de vous référer directement à la référence commerciale La Fabbrica.

ACHTUNG: Für besondere Installationen können besondere Artikel oder Sonderzubehör notwendig sein, die nicht im vorliegenden Katalog aufgeführt sind. Wenden Sie sich bitte in diesen Fällen direkt an den Vertrieb von La Fabbrica.

ATENCIÓN: para instalaciones particulares podrían requerirse artículos y accesorios específicos que no están presentes en este catálogo. Para tales casos rogamos contactar directamente al representante comercial de La Fabbrica.

ВНИМАНИЕ: Для особых применений могут быть необходимы специальные артикулы и аксессуары, не представленные в данном каталоге. По поводу этих вопросов просим вас обращаться непосредственно к менеджеру коммерческого отдела компании La Fabbrica.





Wall: Silver: 10x30 (1" x 1 1/2") Nat. Ret. - Decoro Esagona Silver 28x29 (1 1/4" x 1 1/4") Nat. Ret. / Floor: Silver: 120x120 (48" x 48") Nat. Ret. - Decoro Spina di pesce Silver 33,5x30 (13" x 12") Nat. Ret.

GRES PORCELLANATO COLORATO IN MASSA . COLORED BODY PORCELAIN STONEWARE  
GRÈS CÉRAMÉ COLORÉ DANS LA MASSE . EINGEFÄRBTES FEINSTEINZEUG  
GRES PORCELÁNICO COLOREADO EN MASA . КЕРАМОГРАНИТ ОКРАШЕННЫЙ В МАССЕ  
ISO 13006 - G - B1a (E ≤ 0,5%) - UNI EN 14411 - G

100% DESIGN  
AND PRODUCTION  
OF ITALY

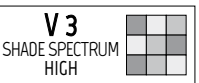

INDOOR

R10-B (naturale)

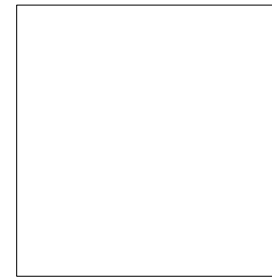

120x120 . 48"x48"  
Nat. Ret.  
120x120 . 48"x48"  
Lap. Ret.

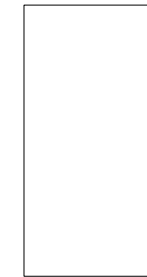

60x120 . 24"x48"  
Nat. Ret.  
60x120 . 24"x48"  
Lap. Ret.



60x60 . 24"x24"  
Nat. Ret.  
60x60 . 24"x24"  
Lap. Ret.

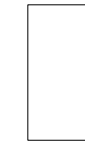

30x60 . 12"x24"  
Nat. Ret.  
30x60 . 12"x24"  
Lap. Ret.



10x30 . 4"x12"  
Nat. Ret.  
10x30 . 4"x12"  
Lap. Ret.

8,8 mm

modular system



Spina di pesce  
33,5x30 . 13"x12"  
Nat. Ret.



Esagona  
28x29 . 11"x11 1/2"  
Nat. Ret.



Intreccio  
30x30 . 12"x12"  
Nat. Ret.



Muretto  
30x30 . 12"x12"  
Nat. Ret.

SVILUPPO GRAFICO PER FORMATO  
Pattern by size  
Développement graphique par format  
Grafischer Entwurf für Format  
Desarrollo gráfico por formato  
Варианты графики для каждого формата

	120x120	60x120	60x60	30x60	10x30
	8,8 mm	8,8 mm	8,8 mm	8,8 mm	8,8 mm
	7	17	24	68	408

# JUNGLE STONE

8,8 mm R10-B (naturale)



Wall  
Decoro Intreccio Bone 30x30 (12"x12") Nat. Ret.  
Bone 10x30 (4"x12") Nat. Ret.

Floor  
Silver 60x60 (24"x24") Nat. Ret.



Floor  
Desert 60x120 (24"x48") Nat. Ret.  
Decoro Spina di pesce Desert 33,5x30 (13"x12") Nat. Ret.

# JUNGLE STONE

## SILVER

INDOOR

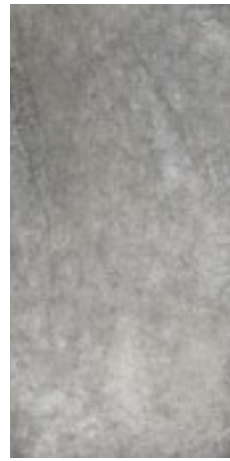

**8,8 mm** R10-B (naturale)



**154041**  
120x120 . 48"x48"  
Nat. Ret.

**154001**  
60x120 . 24"x48"  
Nat. Ret.

**154011**  
60x60 . 24"x24"  
Nat. Ret.

**154021**  
30x60 . 12"x24"  
Nat. Ret.

**154031**  
10x30 . 4"x12"  
Nat. Ret.

**154046**  
120x120 . 48"x48"  
Lap. Nat.

**154006**  
60x120 . 24"x48"  
Lap. Nat.

**154016**  
60x60 . 24"x24"  
Lap. Nat.

**154026**  
30x60 . 12"x24"  
Lap. Nat.

**154036**  
10x30 . 4"x12"  
Lap. Nat.

modular system



**154301**  
Spina di pesce  
33,5x30 . 13"x12"  
Nat. Ret.



**154311**  
Esagona  
28x29 . 11"x11 1/2"  
Nat. Ret.



**154306**  
Intreccio  
30x30 . 12"x12"  
Nat. Ret.



**154316**  
Muretto  
30x30 . 12"x12"  
Nat. Ret.

## BONE

INDOOR



**8,8 mm** R10-B (naturale)



**154043**  
120x120 . 48"x48"  
Nat. Ret.

**154003**  
60x120 . 24"x48"  
Nat. Ret.

**154013**  
60x60 . 24"x24"  
Nat. Ret.

**154023**  
30x60 . 12"x24"  
Nat. Ret.

**154033**  
10x30 . 4"x12"  
Nat. Ret.

**154048**  
120x120 . 48"x48"  
Lap. Nat.

**154008**  
60x120 . 24"x48"  
Lap. Nat.

**154018**  
60x60 . 24"x24"  
Lap. Nat.

**154028**  
30x60 . 12"x24"  
Lap. Nat.

**154038**  
10x30 . 4"x12"  
Lap. Nat.

modular system



**154303**  
Spina di pesce  
33,5x30 . 13"x12"  
Nat. Ret.



**154313**  
Esagona  
28x29 . 11"x11 1/2"  
Nat. Ret.



**154308**  
Intreccio  
30x30 . 12"x12"  
Nat. Ret.



**154318**  
Muretto  
30x30 . 12"x12"  
Nat. Ret.

## GRAVEL

INDOOR

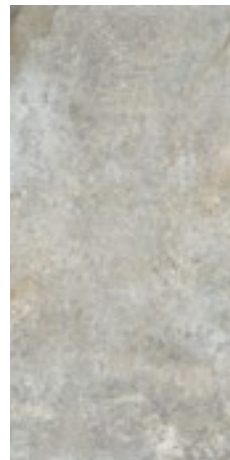

**8,8 mm** R10-B (naturale)



**154042**  
120x120 . 48"x48"  
Nat. Ret.

**154002**  
60x120 . 24"x48"  
Nat. Ret.

**154012**  
60x60 . 24"x24"  
Nat. Ret.

**154022**  
30x60 . 12"x24"  
Nat. Ret.

**154032**  
10x30 . 4"x12"  
Nat. Ret.

**154047**  
120x120 . 48"x48"  
Lap. Nat.

**154007**  
60x120 . 24"x48"  
Lap. Nat.

**154017**  
60x60 . 24"x24"  
Lap. Nat.

**154027**  
30x60 . 12"x24"  
Lap. Nat.

**154037**  
10x30 . 4"x12"  
Lap. Nat.

modular system



**154302**  
Spina di pesce  
33,5x30 . 13"x12"  
Nat. Ret.



**154312**  
Esagona  
28x29 . 11"x11 1/2"  
Nat. Ret.



**154317**  
Muretto  
30x30 . 12"x12"  
Nat. Ret.

## DESERT

INDOOR

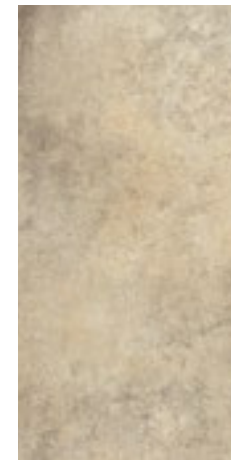
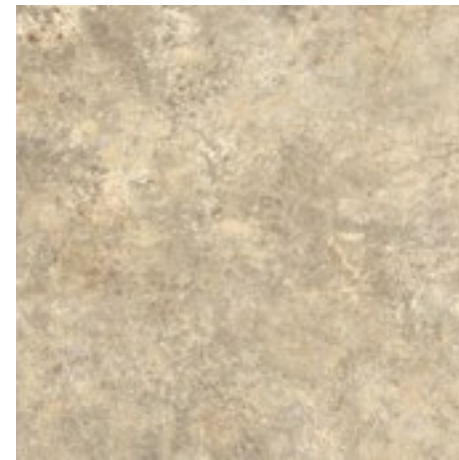

**8,8 mm** R10-B (naturale)

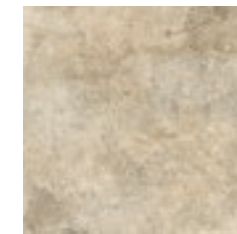

**154044**  
120x120 . 48"x48"  
Nat. Ret.

**154004**  
60x120 . 24"x48"  
Nat. Ret.

**154014**  
60x60 . 24"x24"  
Nat. Ret.

**154024**  
30x60 . 12"x24"  
Nat. Ret.

**154034**  
10x30 . 4"x12"  
Nat. Ret.

**154049**  
120x120 . 48"x48"  
Lap. Ret.

**154009**  
60x120 . 24"x48"  
Lap. Ret.

**154019**  
60x60 . 24"x24"  
Lap. Ret.

**154029**  
30x60 . 12"x24"  
Lap. Ret.

**154039**  
10x30 . 4"x12"  
Lap. Ret.

modular system



**154304**  
Spina di pesce  
33,5x30 . 13"x12"  
Nat. Ret.



**154314**  
Esagona  
28x29 . 11"x11 1/2"  
Nat. Ret.



**154319**  
Muretto  
30x30 . 12"x12"  
Nat. Ret.

# JUNGLE STONE

## WILD

INDOOR



**154045**  
120x120 . 48"x48"  
Nat. Ret.

**154050**  
120x120 . 48"x48"  
Lap. Ret.



**154005**  
60x120 . 24"x48"  
Nat. Ret.

**154010**  
60x120 . 24"x48"  
Lap. Ret.

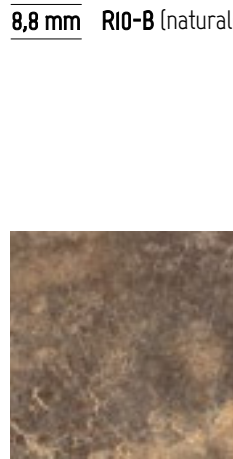

**154015**  
60x60 . 24"x24"  
Nat. Ret.

**154020**  
60x60 . 24"x24"  
Lap. Ret.



**154025**  
30x60 . 12"x24"  
Nat. Ret.

**154030**  
30x60 . 12"x24"  
Lap. Ret.



**154035**  
10x30 . 4"x12"  
Nat. Ret.

**154040**  
10x30 . 4"x12"  
Lap. Ret.

8,8 mm RIO-B (naturale)

modular system



**154305**  
Spina di pesce  
33,5x30 . 13"x12"  
Nat. Ret.



**154315**  
Esagona  
28x29 . 11"x11 1/2"  
Nat. Ret.



**154310**  
Intreccio  
30x30 . 12"x12"  
Nat. Ret.



**154320**  
Muretto  
30x30 . 12"x12"  
Nat. Ret.



Wall  
Wild 60x60 (24"x24") Nat. Ret.

Floor  
Bone 60x120 (24"x48") Nat. Ret. - 60x60 (24"x24") Nat. Ret.

# JUNGLE STONE

8,8 mm RIO-B (naturale)

modular system											ANSI A - 137.1: 2012 WET DYNAMIC COEFFICIENT OF FRICTION		DCOF ≥ 0,42																									
	120x120 48"x48" Nat. Ret.		120x120 48"x48" Lap. Ret.		60x120 24"x48" Nat. Ret.		60x120 24"x48" Lap. Ret.		60x60 24"x24" Nat. Ret.		60x60 24"x24" Lap. Ret.		30x60 12"x24" Nat. Ret.		30x60 12"x24" Lap. Ret.		10x30 4"x12" Nat. Ret.		10x30 4"x12" Lap. Ret.		Decoro Spina di pesce Spina di pesce decorative tile		Intreccio Weave		Decoro Esagona Esagona decorative tile		Muretto Brick-effect mosaic		Battiscopa Skirting		Gradino costa retta Straight-edge step **		Gradino costa retta - Angolo SX / DX Straight-edge step - L/RH corner **					
	120x120 48"x48" Nat. Ret.		120x120 48"x48" Lap. Ret.		60x120 24"x48" Nat. Ret.		60x120 24"x48" Lap. Ret.		60x60 24"x24" Nat. Ret.		60x60 24"x24" Lap. Ret.		30x60 12"x24" Nat. Ret.		30x60 12"x24" Lap. Ret.		10x30 4"x12" Nat. Ret.		10x30 4"x12" Lap. Ret.		33,5x30 13"x12" Nat. Ret.		30x30 12"x12" Nat. Ret.		28x29 11"x11 1/2" Nat. Ret.		30x30 12"x12" Nat. Ret.		7x60 3"x24" Nat. Ret.		33x120x3,2h 13"x48"x1 1/2"h Nat. Ret.		33x120x3,2h 13"x48"x1 1/2"h Lap. Ret.		33x120x3,2h 13"x48"x1 1/2"h Nat. Ret.		33x120x3,2h 13"x48"x1 1/2"h Lap. Ret.	
SILVER	154041	154046	154001	154006	154011	154016	154021	154026	154031	154036											154301	154306	154311	154316	154101	154201	154206	154221 SX 154211 DX	154226 SX 154216 DX									
GRAVEL	154042	154047	154002	154007	154012	154017	154022	154027	154032	154037											154302		154312	154317	154102	154202	154207	154222 SX 154212 DX	154227 SX 154217 DX									
BONE	154043	154048	154003	154008	154013	154018	154023	154028	154033	154038											154303	154308	154313	154318	154103	154203	154208	154223 SX 154213 DX	154228 SX 154218 DX									
DESERT	154044	154049	154004	154009	154014	154019	154024	154029	154034	154039											154304		154314	154319	154104	154204	154209	154224 SX 154214 DX	154229 SX 154219 DX									
WILD	154045	154050	154005	154010	154015	154020	154025	154030	154035	154040											154305	154310	154315	154320	154105	154205	154210	154225 SX 154215 DX	154230 SX 154220 DX									
PREZZO PRICE	€ 54,00 m <sup>2</sup>	€ 64,00 m <sup>2</sup>	€ 46,00 m <sup>2</sup>	€ 54,00 m <sup>2</sup>	€ 38,00 m <sup>2</sup>	€ 50,00 m <sup>2</sup>	€ 34,00 m <sup>2</sup>	€ 50,00 m <sup>2</sup>	€ 56,00 m <sup>2</sup>	€ 72,00 m <sup>2</sup>											€ 122,00 m <sup>2</sup>	€ 130,00 m <sup>2</sup>	€ 272,00 m <sup>2</sup>	€ 100,00 m <sup>2</sup>	€ 5,00 PZ/PCE	€ 140,00 PZ/PCE	€ 148,00 PZ/PCE	€ 164,00 PZ/PCE	€ 176,00 PZ/PCE									
CODICE PREZZO PRICE CODE	M121	M131	M109	M121	M093	M117	M085	M117	M123	M139											M189	M197	M303	M167	P017	P207	P215	P231	P243									
	Pallet 143x123		Epal 80x120		Epal 80x120		Epal 80x120		Epal 80x120												Epal 80x120	Epal 80x120	Epal 80x120	Epal 80x120	Epal 80x120	Epal 80x120	Epal 80x120	Epal 80x120	Epal 80x120	Epal 80x120								
IMBALLO cm h. PACKING cm h.	75		75		75		75		81												-	-	-	-	-	-	-	-	-	-								
x	1		2		3		6		19												6	6	6	6	15	2	1											
m <sup>2</sup> x	1,44		1,44		1,08		1,08		0,57												0,60	0,54	0,48	0,54	0,63	-	-	-	-	-								
Kg x	28,8		29,82		22,84		22,64		11,43												11,71	10,36	9,41	10,36	13,28	20,70	10,80											
x	40		32		40		48		72												60	60	60	60	-	-	-	-	-									
m <sup>2</sup> x	57,6		46,08		43,20		51,84		41,04												36,00	32,40	28,80	32,40	-	-	-	-	-									
Kg x	1152		974		934		1107		843												722,60	641,60	584,60	641,60	-	-	-	-	-									

I PESI RIPORTATI IN TABELLA SONO INDICATIVI IN QUANTO POSSONO SUBIRE LEGGERE VARIAZIONI PER MOTIVI PRODUTTIVI.

The weights stated in the chart are approximate as some changes may be necessary for production reasons.

Les poids figurant dans le tableau sont fournis à titre indicatif car ils peuvent subir de légères variations pour des raisons de production.

Die in der Tabelle aufgeführten Gewichte sind nicht bindend, da sie aus Produktionsgründen leichte Änderungen aufweisen können.

Los pesos señalados en la tabla son aproximados ya que pueden experimentar ligeras variaciones por motivos productivos.

Указанный в таблице вес является приблизительным, так как ввиду производственных необходимости, он может слегка измениться.

\*\* A DISPOSIZIONE SOLO SU RICHIESTA. TEMPI DI CONSEGNA: 30GG.

Available upon request only. Delivery terms: 30 days.

Disponible seulement sur requête. Délais de livraison: 30 jours.

Verfügbar auf Anfrage. Lieferzeit: 30 Tage.

Disponible sólo bajo pedido. Plazo de entrega: 30 días.

Изготавливается только по специальной заявке. Срок поставки: 30 дней.



# LE PIETRE D'EUROPA

INDOOR - Wall: Lux Dark 50x100 (20"x40") Nat. Ret. / Floor: Lux Fumo 100x100 (40"x40") Nat. Ret.

GRES PORCELLANATO COLORATO IN MASSA . COLORED BODY PORCELAIN STONEWARE  
GRÈS CÉRAME COLORÉ DANS LA MASSE . EINGEFÄRBTES FEINSTEINZEUG  
GRES PORCELÁNICO COLOREADO EN MASA . КЕРАМОГРАНИТ ОКРАШЕННЫЙ В МАССЕ  
ISO 13006 - G - B1a (E ≤ 0,5%) - UNI EN 14411 - G

100% DESIGN AND PRODUCTION OF ITALY

V2 SHADE SPECTRUM MODERATE

## INDOOR

R10-B

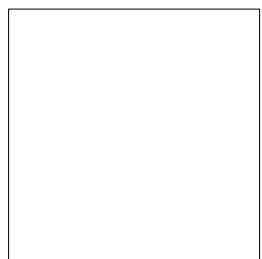

100x100 . 40"x40"  
Nat. Ret.

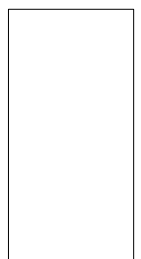

50x100 . 20"x40"  
Nat. Ret.

10 mm

modular system

## OUTDOOR

R11-C

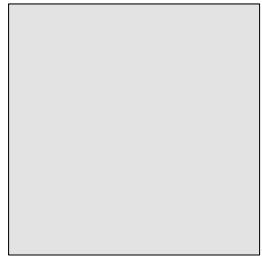

100x100 . 40"x40"  
Nat. Ret.

10 mm

R11-C

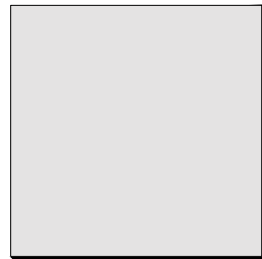

100x100 . 40"x40"  
Nat. Ret.

20 mm

SVILUPPO GRAFICO PER FORMATO Pattern by size Développement graphique par format Grafischer Entwurf für Format Desarrollo gráfico por formato Варианты графики для каждого формата	100x100 10 mm 20 mm	50x100 10 mm 20
	10	20

# LE PIETRE D'EUROPA

## LUX DARK

INDOOR



**151003**  
**100x100** . 40"x40"  
Nat. Ret.



**151013**  
**50x100** . 20"x40"  
Nat. Ret.

10 mm R10-B

modular system

## LUX FUMO

INDOOR



**151002**  
**100x100** . 40"x40"  
Nat. Ret.



**151012**  
**50x100** . 20"x40"  
Nat. Ret.

10 mm R10-B

modular system

OUTDOOR

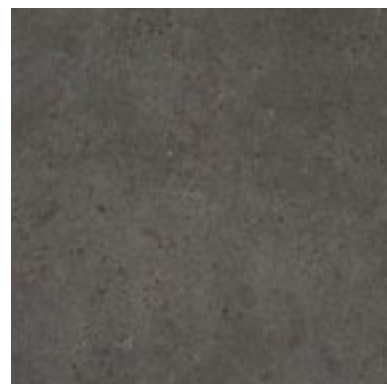

**151033**  
**100x100** . 40"x40"  
Nat. Ret.

10 mm R11-C

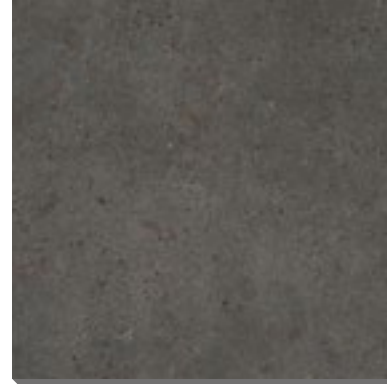

**151043**  
**100x100** . 40"x40"  
Nat. Ret.

20 mm R11-C

OUTDOOR

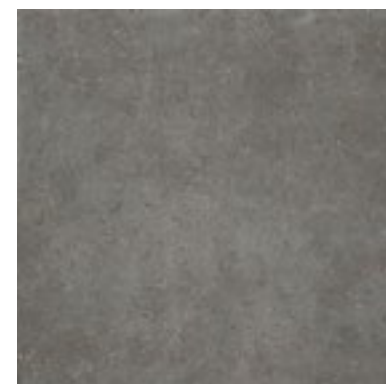

**151032**  
**100x100** . 40"x40"  
Nat. Ret.

10 mm R11-C



**151042**  
**100x100** . 40"x40"  
Nat. Ret.

20 mm R11-C

# LE PIETRE D'EUROPA

## JURA

INDOOR



151001  
100x100 . 40"x40"  
Nat. Ret.

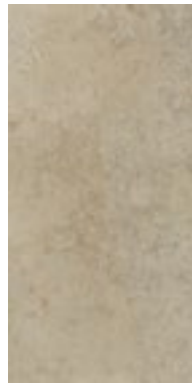

151011  
50x100 . 20"x40"  
Nat. Ret.

10 mm R10-B

modular system

OUTDOOR

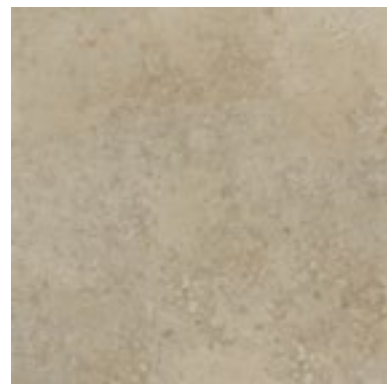

151031  
100x100 . 40"x40"  
Nat. Ret.

10 mm R11-C

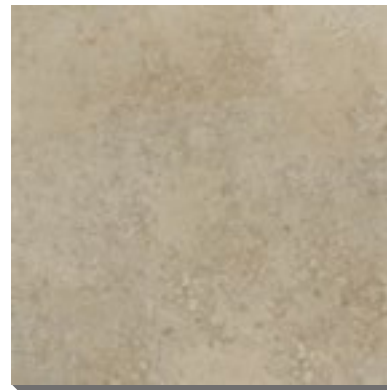

151041  
100x100 . 40"x40"  
Nat. Ret.

20 mm R11-C















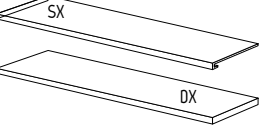

Floor  
Jura 100x100 (40"x40") Nat. Ret. R11





# LE PIETRE D'EUROPA

10 mm R10-B

		modular system				
						
	<b>100x100</b> 40"x40" Nat. Ret.	<b>50x100</b> 20"x40" Nat. Ret.	<b>7x100</b> 3"x40" Nat. Ret.	<b>33x100x3,2h</b> 13"x40"x1 1/4" Nat. Ret.	<b>33x100x3,2h</b> 13"x40"x1 1/4" Nat. Ret.	
LUX DARK 	151003	151013	151103	151203	151215 SX 151209 DX	
LUX FUMO 	151002	151012	151102	151202	151214 SX 151208 DX	
JURA 	151001	151011	151101	151201	151213 SX 151207 DX	
PREZZO PRICE	€ 46,00 m <sup>2</sup>	€ 48,00 m <sup>2</sup>	€ 8,00 PZ/PCE	€ 140,00 PZ/PCE	€ 152,00 PZ/PCE	
CODICE PREZZO PRICE CODE	M109	M113	P029	P207	P219	
	<b>Pallet Spec. con sponde</b> 103x103x60h	<b>Pallet Spec. senza sponde</b> 103x123	<b>Pallet</b> 103x123	<b>Pallet</b> 103x123	<b>Pallet</b> 103x123	
IMBALLO cm h. PACKING cm h.	75	65	-	-	-	
 x 	2	3	6	2	1	
m <sup>2</sup> x 	2	1,5	-	-	-	
Kg x 	40,75	30,56	9,00	14,00	9,00	
 x 	24	33	-	-	-	
m <sup>2</sup> x 	48,00	49,50	-	-	-	
Kg x 	1.023	1.035	-	-	-	











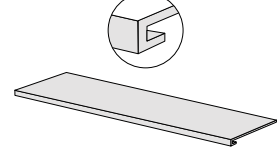
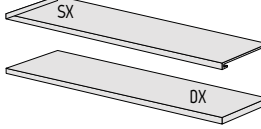

\*\* A DISPOSIZIONE SOLO SU RICHIESTA. TEMPI DI CONSEGNA: 30GG.

Available upon request only. Delivery terms: 30 days.  
Disponible seulement sur requête. Délais de livraison: 30 jours.  
Verfügbar auf Anfrage. Lieferzeit: 30 Tage.  
Disponibile sólo bajo pedido. Plazo de entrega: 30 días.  
Изготавливается только по специальной заявке. Срок поставки: 30 дней.

PER IL GRADINO NON SI GARANTISCE LA STESSA TONALITÀ DEL FONDO.

We cannot guarantee that the shade of the stair tile will be the same as the background tile.  
Pour la marche, nous ne garantissons pas la même tonalité du fond.  
Für die Stufe wird nicht der gleiche Farbton der Grundfliese garantiert.  
Para el peldaño no se garantiza el mismo tono del fondo.  
Для ступени не гарантирована одинаковость тона с фоном.











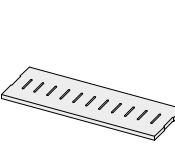
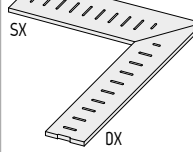
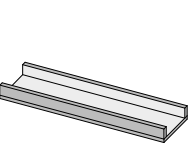
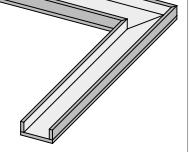
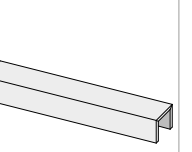
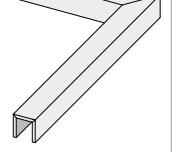
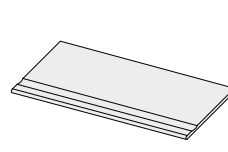
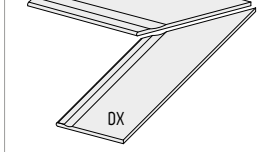
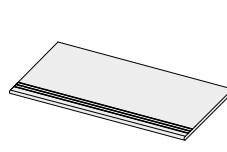
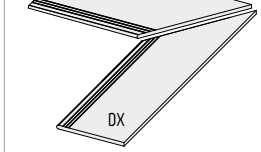
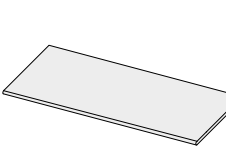
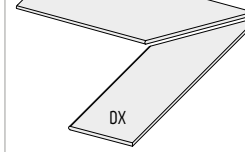

























10 mm R11-C

				ANSI A - 137.1: 2012 WET DYNAMIC COEFFICIENT OF FRICTION	
				DCOF ≥ 0,42	
	<b>100x100</b> 40"x40" Nat. Ret.	<b>33x100x3,2h</b> 13"x40"x1 1/4" Nat. Ret.	<b>33x100x3,2h</b> 13"x40"x1 1/4" Nat. Ret.		
LUX DARK 	151033	151239	151251 SX 151245 DX		
LUX FUMO 	151032	151238	151250 SX 151244 DX		
JURA 	151031	151237	151249 SX 151243 DX		
PREZZO PRICE	€ 46,00 m <sup>2</sup>	€ 140,00 PZ/PCE	€ 152,00 PZ/PCE		
CODICE PREZZO PRICE CODE	M109	P207	P219		
	<b>Pallet Spec. con sponde</b> 103x103x60h	<b>Pallet</b> 103x123	<b>Pallet</b> 103x123		
IMBALLO cm h. PACKING cm h.	75	-	-		
 x 	2	2	1		
m <sup>2</sup> x 	2	-	-		
Kg x 	40,75	14,00	9,00		
 x 	24	-	-		
m <sup>2</sup> x 	48,00	-	-		
Kg x 	1.023	-	-		

# LE PIETRE D'EUROPA

20 mm RII-C

ANSI A - 137.1: 2012  
WET DYNAMIC COEFFICIENT OF FRICTION | DCOF ≥ 0,42

	Griglia 20 Drainage grid 20	Griglia 20 Angolo SX / DX Drainage grid 20 Corner SX / DX	Canalina Channel	Canalina Angolo SX / DX Channel Corner SX / DX	Cordolo U-Border	Cordolo Angolo SX / DX U-Border Corner SX / DX		Gradone bordo svasato Large step with rounded border	Gradone bordo svasato Angolo SX / DX Large step with rounded border Corner SX / DX	Gradone bordo 50 grip Large step 50 with anti-slip border	Gradone bordo 50 grip Angolo SX / DX Large step 50 with anti-slip border Corner SX / DX	Gradone bordo 50 Large step 50	Gradone bordo 50 Angolo SX / DX Large step 50 Corner SX / DX							
	 100x100 40"x40" Nat. Ret.	 20x100 8"x40"	 20x100 8"x40"	 20x100x8h 8"x40"x3"h	 20x100x8h 8"x40"x3"h	 13x100x13h 5"x40"x5"h	 13x100x13h 5"x40"x5"h		 50x100 20"x40"	 50x100 20"x40"	 50x100 20"x40"	 50x100 20"x40"	 50x100 20"x40"	 50x100 20"x40"						
	 	 	 	 	 	 		 	 	 	 	 	 							
LUX DARK 	151043	151448	151454 SX 151451 DX	151439	151445 SX 151442 DX	151457	151463 SX 151460 DX		151493	151484	151499 SX 151496 DX	151490 SX 151487 DX	151475	151466	151481 SX 151478 DX	151472 SX 151469 DX	151412	151403	151418 SX 151415 DX	151409 SX 151406 DX
LUX FUMO 	151042	151447	151453 SX 151450 DX	151438	151444 SX 151441 DX	151456	151462 SX 151459 DX		151492	151483	151498 SX 151495 DX	151489 SX 151486 DX	151474	151465	151480 SX 151477 DX	151471 SX 151468 DX	151411	151402	151417 SX 151414 DX	151408 SX 151405 DX
JURA 	151041	151446	151452 SX 151449 DX	151437	151443 SX 151440 DX	151455	151461 SX 151458 DX		151491	151482	151497 SX 151494 DX	151488 SX 151485 DX	151473	151464	151479 SX 151476 DX	151470 SX 151467 DX	151410	151401	151416 SX 151413 DX	151407 SX 151404 DX
PREZZO PRICE	€ 76,00 m <sup>2</sup>	€ 248,00 PZ/PCE	€ 248,00 PZ/PCE	€ 188,00 PZ/PCE	€ 208,00 PZ/PCE	€ 248,00 PZ/PCE	€ 272,00 PZ/PCE		€ 288,00 PZ/PCE	€ 256,00 PZ/PCE	€ 308,00 PZ/PCE	€ 276,00 PZ/PCE	€ 160,00 PZ/PCE	€ 140,00 PZ/PCE	€ 178,00 PZ/PCE	€ 158,00 PZ/PCE	€ 136,00 PZ/PCE	€ 118,00 PZ/PCE	€ 154,00 PZ/PCE	€ 136,00 PZ/PCE
CODICE PREZZO PRICE CODE	M143	P291	P291	P255	P271	P291	P303		P311	P295	P321	P305	P227	P207	P245	P225	P203	P185	P221	P203
	Pallet 103x103	Pallet 103x103	Pallet 103x103	Pallet 103x103	Pallet 103x103	Pallet 103x103	Pallet 103x103		Pallet 103x103	Pallet 103x103	Pallet 103x103	Pallet 103x103	Pallet 103x103	Pallet 103x103	Pallet 103x103	Pallet 103x103	Pallet 103x103	Pallet 103x103	Pallet 103x103	Pallet 103x103
IMBALLO cm h. PACKING cm h.	73	-	-	-	-	-	-		-	-	-	-	-	-	-	-	-	-	-	-
 x 	1	1	1	1	1	1	1		1	1	1	1	1	1	1	1	1	1	1	1
m <sup>2</sup> x 	1	-	-	-	-	-	-		-	-	-	-	-	-	-	-	-	-	-	-
Kg x 	39,95	8,00	8,00	12,00	12,00	15,00	15,00		15,00	15,00	15,00	15,00	15,00	15,00	15,00	15,00	15,00	15,00	15,00	15,00
 x 	24	-	-	-	-	-	-		-	-	-	-	-	-	-	-	-	-	-	-
m <sup>2</sup> x 	24,00	-	-	-	-	-	-		-	-	-	-	-	-	-	-	-	-	-	-
Kg x 	976	-	-	-	-	-	-		-	-	-	-	-	-	-	-	-	-	-	-

IL PESO DEI PEZZI SPECIALI 20 MM INDICATO IN TABELLA SI RIFERISCE AL PESO DEL SINGOLO PEZZO. PER CALCOLARE IL PESO COMPLESSIVO DEL MATERIALE IMBALLATO OCCORRERÀ AGGIUNGERE AL PESO IN TABELLA IL PESO DELL'IMBALLO E DELLA PALETTA (PESO VARIABILE DA 10 A 30 KG IN FUNZIONE DELLA QUANTITÀ E DELLA TIPOLOGIA DEI PEZZI SPECIALI RICHIESTI).

The weight of the 20 mm TRIMS stated in the table refers to the weight of each trim. To calculate the total weight of the packed material, you will need to add the combined weight of the packing materials and the pallet (weight ranging from 10 to 30kg depending on the quantity and the type of the TRIMS required) to the weight stated in the table.

Le poids des PIÈCES SPECIALES 20 mm indique dans le tableau se réfère au poids individuel de chaque pièce. Pour calculer le poids total du matériel emballé, il faudra ajouter au poids indiqué dans le tableau le poids de l'emballage et de la palette (poids variable de 10 à 30 kg en fonction de la quantité et du type de PIÈCES SPECIALES demandées).

Das in der Tabelle angegebene Gewicht der 20 mm-SONDERTEILE bezieht sich auf das Gewicht des Einzelteils. Zur Berechnung des Gesamtgewichts des verpackten Materials muss zum in der Tabelle aufgeführten Wert das Gewicht der Verpackung und der Palette (von 10 bis 30 kg variierbar in Abhängigkeit von der Menge und Art der gewünschten SONDERTEILE) dazugerechnet werden.

El peso de las PIEZAS ESPECIALES 20 mm indicado en la tabla se refiere al peso de cada pieza singularmente considerada. Para calcular el peso total del material embalado se deberá agregar al peso según la tabla, el peso del embalaje y del palet (peso variable entre 10 y 30 kg en función de la cantidad y tipo de las PIEZAS ESPECIALES requeridas).

Указанный в таблице вес СПЕЦИАЛЬНЫХ ИЗДЕЛИЙ 20 мм - это вес каждого отдельного изделия. Для расчета общего веса упакованного материала необходимо добавить к указанному в таблице значению вес упаковки и поддона (вес может составлять от 10 до 30 кг, в зависимости от количества и типа заказанных СПЕЦИАЛЬНЫХ ИЗДЕЛИЙ)



**Costa toro.**  
Bullnose edge.  
Bord boudin.  
Abgerundete Kante.  
Canto redondo  
Закругленная кромка



**Costa retta.**  
Straight edge.  
Bord droit.  
Gerade Kante.  
Canto recto  
Прямоугольная кромка

**ATTENZIONE:** Per particolari installazioni potrebbero essere necessari articoli ed accessori specifici non presenti in questo catalogo. Per queste esigenze prego riferirsi direttamente al referente commerciale La Fabbrica.

N.B. Particular items and accessories not listed in this catalogue may be required for certain laying methods. For these needs, please contact the La Fabbrica sales sales directly.

ATTENTION : Pour les installations particulières, certains articles et accessoires particuliers qui ne sont pas indiqués dans ce catalogue pourraient être nécessaires. Dans ces cas-là, nous vous prions de vous référer directement à la référence commerciale La Fabbrica.

ACHTUNG: Für besondere Installationen können besondere Artikel oder Sonderzubehör notwendig sein, die nicht im vorliegenden Katalog aufgeführt sind. Wenden Sie sich bitte in diesen Fällen direkt an den Vertrieb von La Fabbrica.

ATENCIÓN: para instalaciones particulares podrían requerirse artículos y accesorios específicos que no están presentes en este catálogo. Para tales casos rogamos contactar directamente al representante comercial de La Fabbrica.

ВНИМАНИЕ: Для особых применений могут быть необходимы специальные артикулы и аксессуары, не представленные в данном каталоге. По поводу этих вопросов просим вас обращаться непосредственно к менеджеру коммерческого отдела компании La Fabbrica.

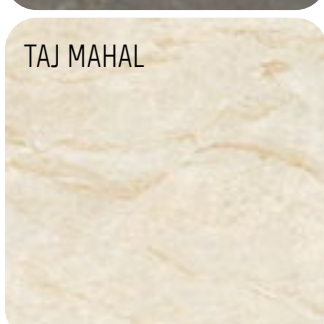
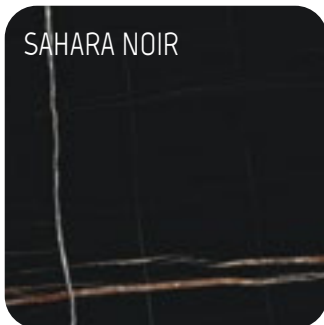

Wall: Flower Sahara Noir 60x120 (24"x48") Lap. Ret. | Floor: Sahara Noir 60x120 (24"x48") Lap. Ret.

# MARMI

GRES PORCELLANATO COLORATO IN MASSA . COLORED BODY PORCELAIN STONEWARE  
GRÈS CÉRAME COLORÉ DANS LA MASSE . EINGEFÄRBTES FEINSTEINZEUG  
GRES PORCELÁNICO COLOREADO EN MASA . КЕРАМОГРАНИТ ОКРАШЕННЫЙ В МАССЕ  
ISO 13006 - G - B1a (E ≤ 0,5%) - UNI EN 14411 - G

100% DESIGN  
AND PRODUCTION  
OF ITALY

V2  
SHADE SPECTRUM  
MODERATE

## INDOOR

RI0-A (naturale)

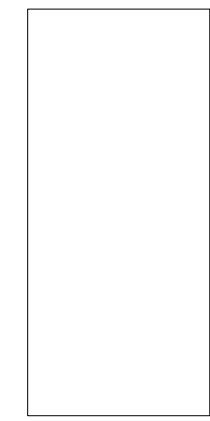

80x180 . 31 1/2"x71"  
Lap. Ret.

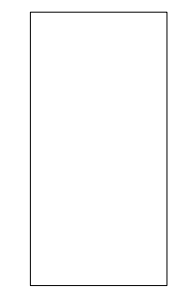

60x120 . 24"x48"  
Nat. Ret.  
60x120 . 24"x48"  
Lap. Ret.



20x120 . 8"x48"  
Nat. Ret.  
20x120 . 8"x48"  
Lap. Ret.

10 mm

— modular system —

SVILUPPO GRAFICO PER FORMATO  
Different patterns (based on size)  
Différents graphismes par format  
Je nach Format verschiedene Grafiken  
Gráficas diferentes según formato  
Кол. Вариантов графики для каждого формата

80x180	60x120	20x120
10 mm	10 mm	10 mm
11	13	39

# MARMI

10 mm



Wall  
Flower Sahara Noir 60x120 (24"x48") Lap. Ret.

Floor  
Sahara Noir 60x120 (24"x48") Lap. Ret.

# MARMI

10 mm RIO-A (naturale)



Floor  
Covelano 60x120 (24"x48") Nat. Ret.



Wall  
Tavolo/Table cucina/Backsplash AVA Extraordinary Size Marmi Bronze Amani  
320x160 (126"x63") Lap. Ret.

Floor  
Bronze Amani 80x180 (31 1/2"x71") Lap. Ret.

# MARMI

## SAHARA NOIR

INDOOR

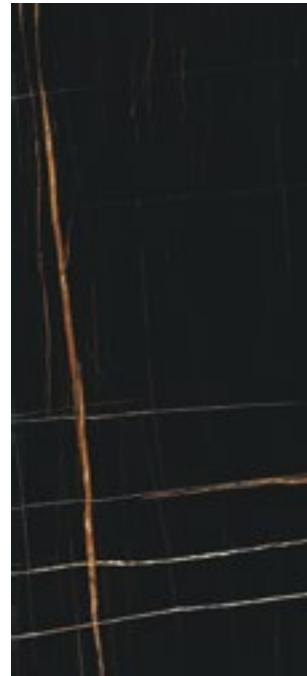

10 mm

**I35051**  
80x180 . 31 1/2"x71"  
Lap. Ret.

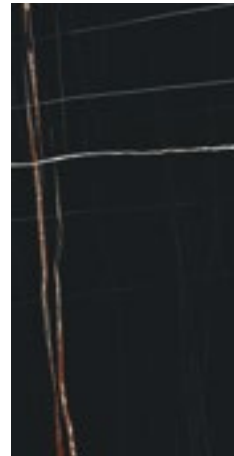

**I35061**  
60x120 . 24"x48"  
Lap. Ret.

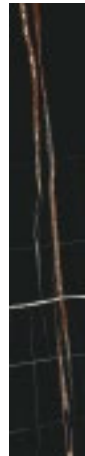

**I35075**  
20x120 . 8"x48"  
Lap. Ret.



**I35101**  
Flower (da rivestimento)  
60x120 . 24"x48"  
Lap. Ret.

modular system

## COVELANO

INDOOR

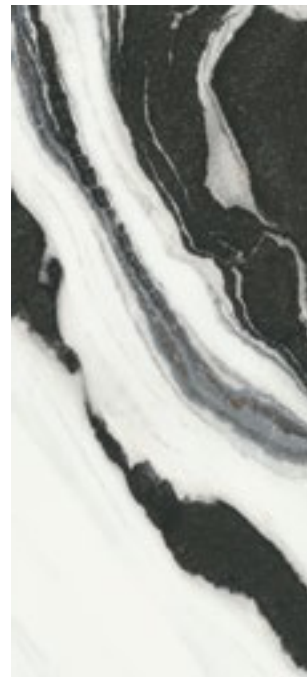

10 mm R10-A (naturale)

**I35056**  
80x180 . 31 1/2"x71"  
Lap. Ret.



**I35067**  
60x120 . 24"x48"  
Nat. Ret.



**I35081**  
20x120 . 8"x48"  
Nat. Ret.



**I35104**  
Liberty (da rivestimento)  
60x120 . 24"x48"  
Lap. Ret.

**I35066**  
60x120 . 24"x48"  
Lap. Ret.

**I35080**  
20x120 . 8"x48"  
Lap. Ret.

modular system

## ARABESQUE NERO

INDOOR



10 mm R10-A (naturale)

**I35052**  
80x180 . 31 1/2"x71"  
Lap. Ret.

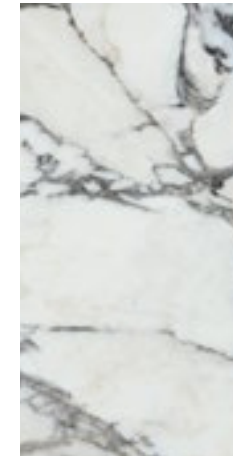

**I35063**  
60x120 . 24"x48"  
Nat. Ret.



**I35077**  
20x120 . 8"x48"  
Nat. Ret.

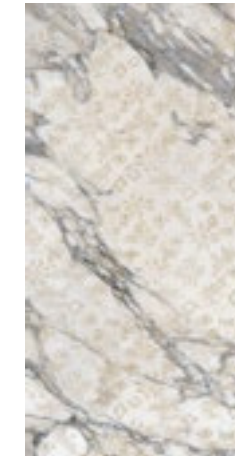

**I35105**  
Japan (da rivestimento)  
60x120 . 24"x48"  
Lap. Ret.

**I35062**  
60x120 . 24"x48"  
Lap. Ret.

**I35076**  
20x120 . 8"x48"  
Lap. Ret.

modular system

## INVISIBLE GREY

INDOOR

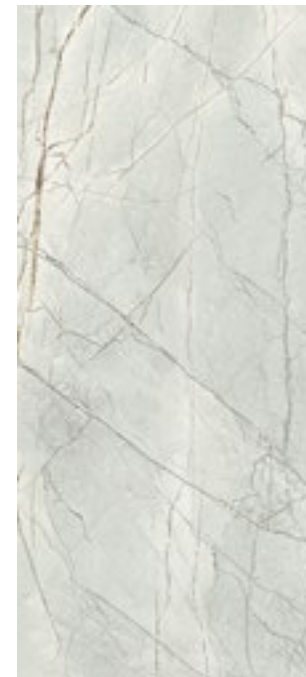

10 mm R10-A (naturale)

**I35054**  
80x180 . 31 1/2"x71"  
Lap. Ret.



**I35065**  
60x120 . 24"x48"  
Nat. Ret.



**I35079**  
20x120 . 8"x48"  
Nat. Ret.

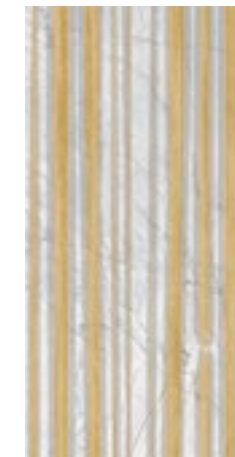

**I35102**  
Conceptual (da rivestimento)  
60x120 . 24"x48"  
Lap. Ret.

**I35064**  
60x120 . 24"x48"  
Lap. Ret.

**I35078**  
20x120 . 8"x48"  
Lap. Ret.

modular system

# MARMI

## BRONZE AMANI

INDOOR



**135060**  
**80x180** . 31 1/2"x71"  
Lap. Ret.

**10 mm** RIO-A (naturale)



**135071**  
**60x120** . 24"x48"  
Nat. Ret.

**135070**  
**60x120** . 24"x48"  
Lap. Ret.



**135085**  
**20x120** . 8"x48"  
Nat. Ret.

**135084**  
**20x120** . 8"x48"  
Lap. Ret.



**135107**  
Rombi (da rivestimento)  
**60x120** . 24"x48"  
Lap. Ret.

modular system

### LA SERIE BRONZE AMANI SI COMPLETA CON LE GRANDI LASTRE DEL CATALOGO AVA

The Bronze Amani series is completed with the large slabs which can be seen in the AVA

La série Bronze Amani est complétée par les grandes dalles du catalogue AVA

Die Serie Bronze Amani wird durch die großen Platten des Katalogs AVA auf Seite 94 ergänzt.

La serie Bronze Amani se completa con las grandes planchas del catálogo AVA

Серия Bronze Amani дополняется большими плитами из каталога Ava

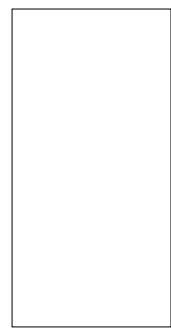

**320x160** . 126"x63"

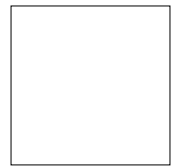

**160x160** . 63"x63"



**160x80** . 63"x31 1/2"



**80x80** . 31 1/2"x31 1/2"

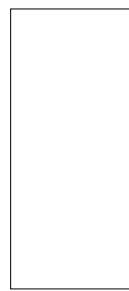

**280x120** . 110"x48"

**6 mm**

modular system

### I VETTORIALI DELLE GRANDI LASTRE NON SONO IN SCALA CON QUELLI DI LA FABBRICA

The vector images of the large slabs are not in scale with the La Fabbrica images.

Les vecteurs des grandes dalles ne sont pas à l'échelle avec ceux de La Fabbrica.

Die Vektorbilder der großen Platten sind nicht maßstabsgetreu zu denen von La Fabbrica.

Los vectoriales de las grandes planchas no están a escala con aquellos de La Fabbrica.

Масштаб векторных изображений больших плит не совпадает с масштабом векторных изображений La Fabbrica.

## TAJ MAHAL

INDOOR

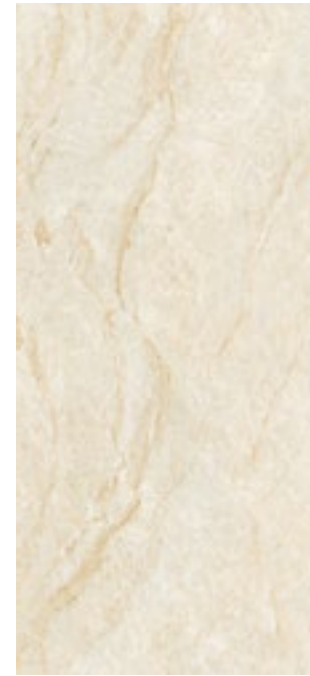

**135058**  
**80x180** . 31 1/2"x71"  
Lap. Ret.

**10 mm** RIO-A (naturale)

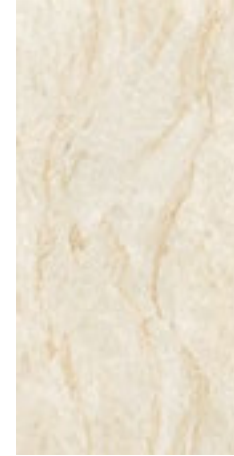

**135069**  
**60x120** . 24"x48"  
Nat. Ret.

**135068**  
**60x120** . 24"x48"  
Lap. Ret.



**135083**  
**20x120** . 8"x48"  
Nat. Ret.

**135082**  
**20x120** . 8"x48"  
Lap. Ret.

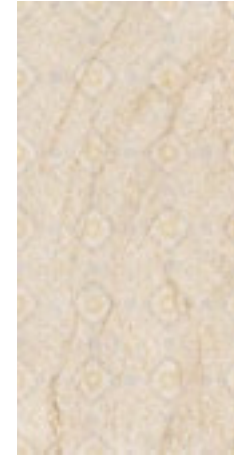

**135106**  
Jaquard (da rivestimento)  
**60x120** . 24"x48"  
Lap. Ret.

modular system

### LA SERIE TAJ MAHAL SI COMPLETA CON LE GRANDI LASTRE DEL CATALOGO AVA

The Taj Mahal series is completed with the large slabs which can be seen in the AVA

La série Taj Mahal est complétée par les grandes dalles du catalogue AVA

Die Serie Taj Mahal wird durch die großen Platten des Katalogs AVA

La serie Taj Mahal se completa con las grandes planchas del catálogo AVA

Серия Taj Mahal дополняется большими плитами из каталога Ava

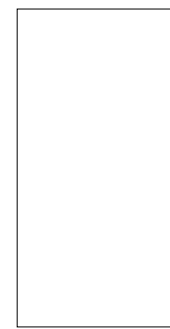

**320x160** . 126"x63"



**160x160** . 63"x63"



**160x80** . 63"x31 1/2"



**80x80** . 31 1/2"x31 1/2"



**280x120** . 110"x48"

**6 mm**

modular system

### I VETTORIALI DELLE GRANDI LASTRE NON SONO IN SCALA CON QUELLI DI LA FABBRICA

The vector images of the large slabs are not in scale with the La Fabbrica images.

Les vecteurs des grandes dalles ne sont pas à l'échelle avec ceux de La Fabbrica.

Die Vektorbilder der großen Platten sind nicht maßstabsgetreu zu denen von La Fabbrica.

Los vectoriales de las grandes planchas no están a escala con aquellos de La Fabbrica.

Масштаб векторных изображений больших плит не совпадает с масштабом векторных изображений La Fabbrica.

# MARMI

10 mm RIO-A

Solo superficie naturale  
Only natural surface

ANSI A - 137.1: 2012  
WET DYNAMIC COEFFICIENT OF FRICTION | DCOF ≥ 0,42

		modular system								Decoro Flower Flower decorative tile **	Decoro Liberty Liberty decorative tile **	Decoro Japan Japan decorative tile **		Decoro Conceptual Conceptual decorative tile **	Decoro Rombi Rombi decorative tile **	Decoro Jaquard Jaquard decorative tile **	Battiscopa Skirting	Gradino costa retta Straight-edge step **	Gradino costa retta - Angolo SX / DX Straight-edge step - LH/RH corner **		
		80x180 31 1/2"x71" Lap. Ret.	60x120 24"x48" Nat. Ret.	60x120 24"x48" Lap. Ret.	20x120 8"x48" Nat. Ret.	20x120 8"x48" Lap. Ret.	60x120 24"x48" Lap. Ret.	60x120 24"x48" Lap. Ret.	60x120 24"x48" Lap. Ret.	60x120 24"x48" Lap. Ret.	60x120 24"x48" Lap. Ret.	60x120 24"x48" Lap. Ret.	60x120 24"x48" Lap. Ret.	60x120 24"x48" Lap. Ret.	6,5x120 2 1/2"x48" Nat. Ret.	6,5x120 2 1/2"x48" Lap. Ret.	33x120x3,2h 13"x48"x1 1/4"h Nat. Ret.	33x120x3,2h 13"x48"x1 1/4"h Lap. Ret.	33x120x3,2h 13"x48"x1 1/4"h Nat. Ret.	33x80x3,2h 13"x31 1/2"x1 1/4"h Lap. Ret.	
SAHARA NOIR	135051	-	135061	-	135075	135101	-	-	-	-	-	-	-	-	-	135201	-	135331	-	135333 SX 135332 DX	
COVELANO	135056	135067	135066	135081	135080	-	135104	-	-	-	-	-	-	-	135207	135206	135310	135340	135312 SX 135311 DX	135342 SX 135341 DX	
ARABESQUE NERO	135052	135063	135062	135077	135076	-	-	135105	-	-	-	-	-	-	135203	135202	135304	135334	135306 SX 135305 DX	135336 SX 135335 DX	
INVISIBLE GREY	135054	135065	135064	135079	135078	-	-	-	135102	-	-	-	-	-	135205	135204	135307	135337	135309 SX 135308 DX	135339 SX 135338 DX	
BRONZE AMANI	135060	135071	135070	135085	135084	-	-	-	-	-	-	-	135107	-	135211	135210	135316	135346	135318 SX 135317 DX	135348 SX 135347 DX	
TAJ MAHAL	135058	135069	135068	135083	135082	-	-	-	-	-	-	-	-	135106	135209	135208	135313	135343	135315 SX 135314 DX	135345 SX 135344 DX	
PREZZO PRICE	SAHARA NOIR € 84,00 m <sup>2</sup>	€ 76,00 m <sup>2</sup>	€ 46,00 m <sup>2</sup>	SAHARA NOIR € 66,00 m <sup>2</sup>	€ 58,00 m <sup>2</sup>	€ 48,00 m <sup>2</sup>	SAHARA NOIR € 70,00 m <sup>2</sup>	€ 62,00 m <sup>2</sup>	€ 518,00 SET 3 PZ/PCES	€ 174,00 PZ/PCE	€ 174,00 PZ/PCE		€ 518,00 SET 3 PZ/PCES	€ 174,00 PZ/PCE	€ 174,00 PZ/PCE	€ 8,00 PZ/PCE	€ 9,00 PZ/PCE	€ 140,00 PZ/PCE	€ 148,00 PZ/PCE	€ 164,00 PZ/PCE	€ 176,00 PZ/PCE
CODICE PREZZO PRICE CODE	MI51	MI43	MI09	MI33	MI25	MI13	MI37	MI29	P423	P241	P241		P423	P241	P241	P029	P033	P207	P215	P231	P243
		Pallet con sponde 97x188	Epil 80x120	Epil 80x120	Epil 80x120	Epil 80x120	Epil 80x120	Epil 80x120	Epil 80x120	Epil 80x120	Epil 80x120	Epil 80x120	Epil 80x120	Epil 80x120	Epil 80x120	Epil 80x120	Epil 80x120	Epil 80x120	Epil 80x120	Epil 80x120	
IMBALLO cm h. PACKING cm h.	95	75	55	-	-	-	-	-	-	-	-	-	-	-	-	-	-	-	-	-	
□ x □	2	2	6	3	1	1	3	1	1	6	2	1	1	6	2	1	1	2	1	1	
m <sup>2</sup> x □	2,88	1,44	1,44	2,16	0,72	0,72	2,16	0,72	0,72	-	-	-	-	-	-	-	-	-	-	-	
Kg x □	69,12	33,12	31,68	47,50	15,84	15,84	47,50	15,84	15,84	11,00	23,00	12,00	-	-	-	-	-	-	-	-	
□ x □	20	30	24	-	-	-	-	-	-	-	-	-	-	-	-	-	-	-	-	-	
m <sup>2</sup> x □	57,60	43,20	34,56	-	-	-	-	-	-	-	-	-	-	-	-	-	-	-	-	-	
Kg x □	1.412	1.013	780	-	-	-	-	-	-	-	-	-	-	-	-	-	-	-	-	-	

\*\* A DISPOSIZIONE SOLO SU RICHIESTA. TEMPI DI CONSEGNA: 30GG.

Available upon request only. Delivery terms: 30 days.  
Disponible seulement sur requête. Délais de livraison: 30 jours.  
Verfügbar auf Anfrage. Lieferzeit: 30 Tage.  
Disponibile sólo bajo pedido. Plazo de entrega: 30 días.  
Изготавливается только по специальной заявке. Срок поставки: 30 дней.

PER IL GRADINO NON SI GARANTISCE LA STESSA TONALITÀ DEL FONDO.

We cannot guarantee that the shade of the stair tile will be the same as the background tile.  
Pour la marche, nous ne garantissons pas la même tonalité du fond.  
Für die Stufe wird nicht der gleiche Farbton der Grundfliese garantiert.  
Para el peldaño no se garantiza el mismo tono del fondo.  
Для ступени не гарантирована одинаковость тона с фоном.



CHENONCEAU

CHEVERNY

CHAMBORD

FONTAINEBLEAU

USSÉ

# PIERRES DES CHATEAUX

Floor: Chenonceau 60x100 (24"x40") Nat. Ret. R11 20 mm

GRES PORCELLANATO COLORATO IN MASSA . COLORED BODY PORCELAIN STONEWARE  
GRÈS CÉRAMÉ COLORÉ DANS LA MASSE . EINGEFÄRBTES FEINSTEINZEUG  
GRES PORCELÁNICO COLOREADO EN MASA . КЕРАМОГРАНИТ ОКРАШЕННЫЙ В МАССЕ  
ISO 13006 - G - B1a (E ≤ 0,5%) - UNI EN 14411 - G

100% DESIGN  
AND PRODUCTION  
OF ITALY

V3  
SHADE SPECTRUM  
HIGH

## INDOOR R10-B

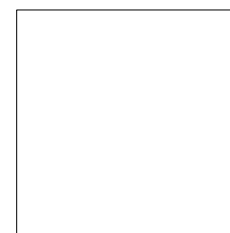

100x100 . 40x40"  
Nat. Ret.



60x120 . 24"x48"  
Nat. Ret.

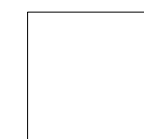

60x60 . 24"x24"  
Nat. Ret.



30x60 . 12"x24"  
Nat. Ret.



10x30 . 4"x12"  
Nat. Ret.

8,8 mm

modular system

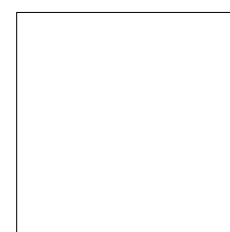

Decoro Rose  
100x100 . 40x40"  
Nat. Ret.



Mosaico  
30x30 . 12"x12"  
Nat. Ret.



Spina di pesce  
30x30 . 12"x12"  
Nat. Ret.



Decoro  
30x26 . 12"x10 1/4"  
Nat. Ret.

8,8 mm

## OUTDOOR R11-C

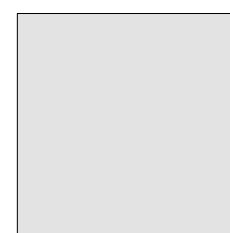

100x100 . 40x40"  
Nat. Ret.

8,8 mm

### R11-C



60x100 . 24"x40"  
Nat. Ret.

20 mm

### SVILUPPO GRAFICO PER FORMATO

Pattern by size  
Développement graphique par format  
Grafischer Entwurf für Format  
Desarrollo gráfico por formato  
Варианты графики для каждого формата

100x100	60x120	60x60	30x60	10x30	60x100
8,8 mm	8,8 mm	8,8 mm	8,8 mm	8,8 mm	20 mm

15	30	16	32	190	15
----	----	----	----	-----	----

# PIERRES DES CHÂTEAUX

8,8 mm RI0-B



Wall  
Chenonceau 30x60 (12"x24") Nat. Ret.

Floor  
Chenonceau 100x100 (40"x40") Nat. Ret.

Floor  
Fontainebleau 100x100 (40"x40") Nat. Ret.

# PIERRES DES CHÂTEAUX

## CHENONCEAU

INDOOR



**158005**  
100x100 . 40"x40"  
Nat. Ret.



**158045**  
60x120 . 24"x48"  
Nat. Ret.

8,8 mm RIO-B



**158015**  
60x60 . 24"x24"  
Nat. Ret.



**158025**  
30x60 . 12"x24"  
Nat. Ret.



**158030**  
10x30 . 4"x12"  
Nat. Ret.

modular system

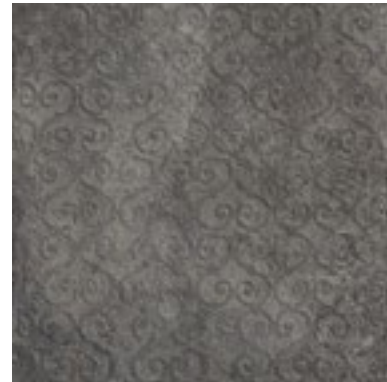

**158055**  
Decoro Rose Chenonceau  
100x100 . 40"x40"  
Nat. Ret.

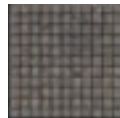

**158305**  
Mosaico  
30x30 . 12"x12"  
Nat. Ret.



**158314**  
Spina di pesce  
30x30 . 12"x12"  
Nat. Ret.



**MOSCP06**  
Dec. Champagne black  
30x26 . 12"x10 1/4"  
Nat. Ret.

OUTDOOR



20 mm RII-C

**158035**  
60x100 . 24"x40"  
Nat. Ret.

## CHEVERNY

INDOOR

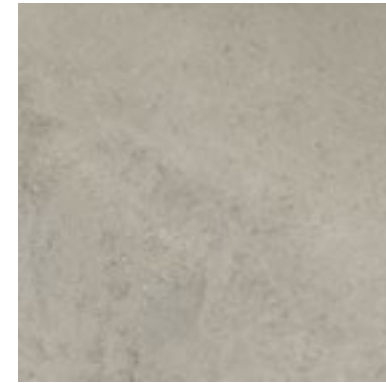

**158001**  
100x100 . 40"x40"  
Nat. Ret.

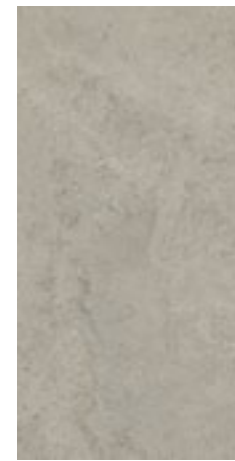

**158041**  
60x120 . 24"x48"  
Nat. Ret.

8,8 mm RIO-B

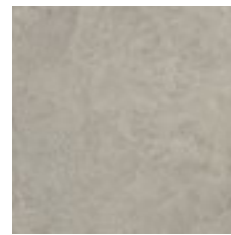

**158011**  
60x60 . 24"x24"  
Nat. Ret.



**158021**  
30x60 . 12"x24"  
Nat. Ret.



**158026**  
10x30 . 4"x12"  
Nat. Ret.

modular system



**158051**  
Decoro Rose Cheverny  
100x100 . 40"x40"  
Nat. Ret.

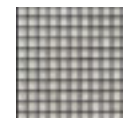

**158301**  
Mosaico  
30x30 . 12"x12"  
Nat. Ret.



**158310**  
Spina di pesce  
30x30 . 12"x12"  
Nat. Ret.



**MOSCP05**  
Dec. Champagne grey  
30x26 . 12"x10 1/4"  
Nat. Ret.

OUTDOOR



8,8 mm RII-C

**158006**  
100x100 . 40"x40"  
Nat. Ret.

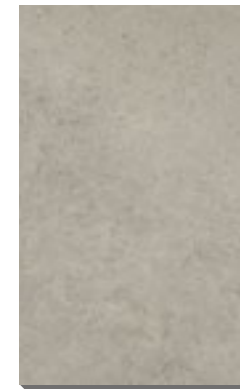

20 mm RII-C

**158031**  
60x100 . 24"x40"  
Nat. Ret.

# PIERRES DES CHÂTEAUX

## CHAMBORD

INDOOR



**I58002**  
100x100 . 40"x40"  
Nat. Ret.



**I58042**  
60x120 . 24"x48"  
Nat. Ret.

8,8 mm RIO-B



**I58012**  
60x60 . 24"x24"  
Nat. Ret.



**I58022**  
30x60 . 12"x24"  
Nat. Ret.

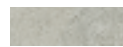

**I58027**  
10x30 . 4"x12"  
Nat. Ret.

modular system



**I58052**  
Decoro Rose Chambord  
100x100 . 40"x40"  
Nat. Ret.

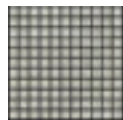

**I58302**  
Mosaico  
30x30 . 12"x12"  
Nat. Ret.



**I58311**  
Spina di pesce  
30x30 . 12"x12"  
Nat. Ret.



**MOSCP03**  
Dec. Amaranone brown  
30x26 . 12"x10 1/4"  
Nat. Ret.

OUTDOOR



**I58007**  
100x100 . 40"x40"  
Nat. Ret.

8,8 mm RII-C

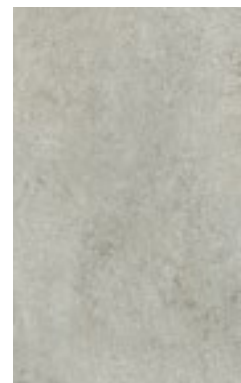

**I58032**  
60x100 . 24"x40"  
Nat. Ret.

20 mm RII-C

## FONTAINEBLEAU

INDOOR



**I58004**  
100x100 . 40"x40"  
Nat. Ret.

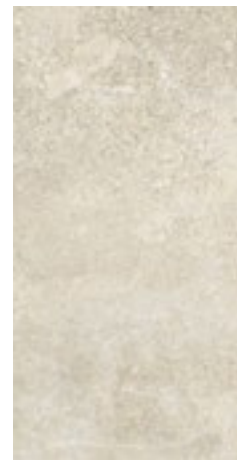

**I58044**  
60x120 . 24"x48"  
Nat. Ret.

8,8 mm RIO-B

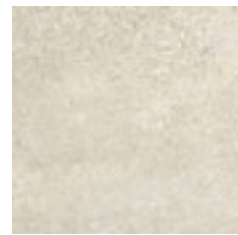

**I58014**  
60x60 . 24"x24"  
Nat. Ret.

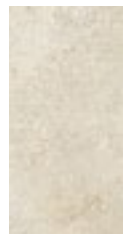

**I58024**  
30x60 . 12"x24"  
Nat. Ret.



**I58029**  
10x30 . 4"x12"  
Nat. Ret.

modular system



**I58054**  
Decoro Rose Fontainebleau  
100x100 . 40"x40"  
Nat. Ret.



**I58304**  
Mosaico  
30x30 . 12"x12"  
Nat. Ret.



**I58313**  
Spina di pesce  
30x30 . 12"x12"  
Nat. Ret.



**MOSCP02**  
Dec. Chardonnay beige  
30x26 . 12"x10 1/4"  
Nat. Ret.

OUTDOOR



**I58009**  
100x100 . 40"x40"  
Nat. Ret.

8,8 mm RII-C

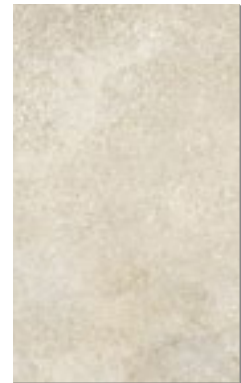

**I58034**  
60x100 . 24"x40"  
Nat. Ret.

20 mm RII-C

# PIERRES DES CHÂTEAUX

## USSÉ

INDOOR

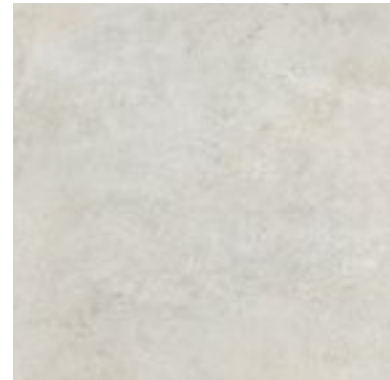

**158003**  
100x100 . 40"x40"  
Nat. Ret.

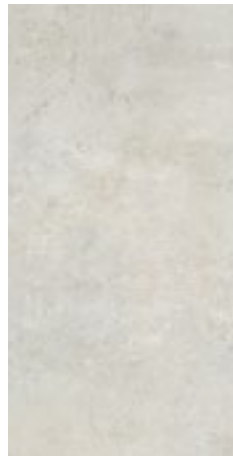

**158043**  
60x120 . 24"x48"  
Nat. Ret.

**8,8 mm** R10-B

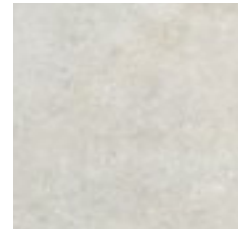

**158013**  
60x60 . 24"x24"  
Nat. Ret.



**158023**  
30x60 . 12"x24"  
Nat. Ret.



**158028**  
10x30 . 4"x12"  
Nat. Ret.

modular system



**158053**  
Decoro Rose Ussé  
100x100 . 40"x40"  
Nat. Ret.

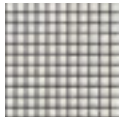

**158303**  
Mosaico  
30x30 . 12"x12"  
Nat. Ret.



**158312**  
Spina di pesce  
30x30 . 12"x12"  
Nat. Ret.



**MOSCP04**  
Dec. Champagne white  
30x26 . 12"x10 1/4"  
Nat. Ret.



**MOSCP01**  
Dec. Pinot grigio white  
30x26 . 12"x10 1/4"  
Nat. Ret.

OUTDOOR

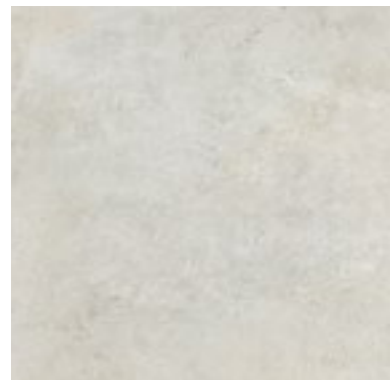

**158008**  
100x100 . 40"x40"  
Nat. Ret.

**8,8 mm** R11-C

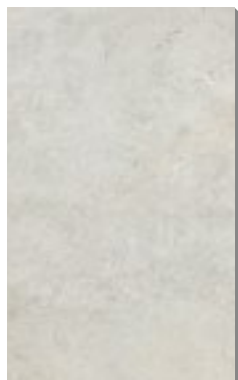

**158033**  
60x100 . 24"x40"  
Nat. Ret.

**20 mm** R11-C











INDOOR  
Wall  
Ussé 100x100 (40"x40") Nat. Ret.

Floor  
Ussé 100x100 (40"x40") Nat. Ret.

# PIERRES DES CHÂTEAUX

8,8 mm RI0-B

ANSI A - 137.1: 2012  
WET DYNAMIC COEFFICIENT OF FRICTION | DCOF ≥ 0,42

	modular system					Decoro Rose Decorative tile Rose	Mosaico Mosaic	Decoro Spina di pesce Decorative tile Spina di pesce	Decoro Decorative tile	Battiscopa Skirting	Gradino costa retta Straight-edge step **	Gradino costa retta - Angolo SX / DX Straight-edge step - LH/RH corner **	
	100x100 40"x40" Nat. Ret.	60x120 24"x48" Nat. Ret.	60x60 24"x24" Nat. Ret.	30x60 12"x24" Nat. Ret.	10x30 4"x12" Nat. Ret.	100x100 40"x40" Nat. Ret.	30x30 12"x12" Nat. Ret.	33,5x30 13"x12" Nat. Ret.	30x26 12"x10 1/4" Nat. Ret.	7x100 3"x40" Nat. Ret.	7x60 3"x24" Nat. Ret.	33x60x3,2h 13"x24"x1 1/4"h Nat. Ret.	33x60x3,2h 13"x24"x1 1/4"h Nat. Ret.
CHENONCEAU	158005	158045	158015	158025	158030	158055	158305	158314	MOSCP06	158105	158115	158205	158225 SX 158215 DX
CHEVERNY	158001	158041	158011	158021	158026	158051	158301	158310	MOSCP05	158101	158111	158201	158221 SX 158211 DX
CHAMBORD	158002	158042	158012	158022	158027	158052	158302	158311	MOSCP03	158102	158112	158202	158222 SX 158212 DX
FONTAINEBLEAU	158004	158044	158014	158024	158029	158054	158304	158313	MOSCP02	158104	158114	158204	158224 SX 158214 DX
USSÉ	158003	158043	158013	158023	158028	158053	158303	158312	MOSCP04 MOSCP01	158103	158113	158203	158223 SX 158213 DX
PREZZO PRICE	€ 46,00 m <sup>2</sup>	€ 40,00 m <sup>2</sup>	€ 36,00 m <sup>2</sup>	€ 32,00 m <sup>2</sup>	€ 56,00 m <sup>2</sup>	€ 50,00 m <sup>2</sup>	€ 92,00 m <sup>2</sup>	€ 122,00 m <sup>2</sup>	€ 240,00 m <sup>2</sup>	€ 8,00 PZ/PCE	€ 5,00 PZ/PCE	€ 74,00 PZ/PCE	€ 102,00 PZ/PCE
CODICE PREZZO PRICE CODE	M109	M097	M089	M081	M123	M117	M159	M189	M287	P029	P017	PI41	PI69
	Pallet speciale con sponde 103x123x60H	Epal 80x120	Epal 80x120	Epal 80x120	Epal 80x120	Pallet speciale con sponde 103x123x60H	Epal 80x120	Epal 80x120	Epal 80x120	Epal 80x120	Epal 80x120	Epal 80x120	Epal 80x120
IMBALLO cm h. PACKING cm h.	75	75	75	75	81	75	81	81	75	-	-	-	-
 x 	2	2	3	6	19	2	6	6	6	6	15	4	2
m <sup>2</sup> x 	2	1,44	1,08	1,08	0,57	2	0,54	0,54	0,47	0,42	0,63	-	-
Kg x 	36,68	29,82	25,54	22,64	12,05	36,68	11,32	11,32	10,74	8,10	13,284	20,70	10,80
 x 	24	32	40	48	72	24	60	60	60	-	-	-	-
m <sup>2</sup> x 	48,00	46,08	43,20	51,84	41,04	48,00	32,4	32,4	28,20	-	-	-	-
Kg x 	925	974	1042	1107	868	925	679	679	664,4	-	-	-	-

TRA I FONDI DI SPESSORE 8,8 E 20 MM NON SI GARANTISCE L'ABBINABILITÀ.

We cannot guarantee tonal matches between the same background tiles with different thickness (8,8 or 20 mm).

Les assortiments des tons ne sont pas garantis pour les fonds d'une épaisseur de 8,8 et 20 mm.

Bei Bodenfliesen mit einer Stärke von 8,8 und 20 mm wird keine Einheitlichkeit der Farbtöne garantiert.

Para los fondos de espesor 8,8 y 20 mm no se garantiza la combinabilidad de tonalidades.

Для фоновой плитки толщиной 8,8 и 20 мм не гарантирована цветовая сочетаемость.

\*\* A DISPOSIZIONE SOLO SU RICHIESTA. TEMPI DI CONSEGNA: 30GG.

Available upon request only. Delivery terms: 30 days.

Disponible seulement sur requête. Délais de livraison: 30 jours.

Verfügbar auf Anfrage. Lieferzeit: 30 Tage.

Disponibile sólo bajo pedido. Plazo de entrega: 30 días.

Изготавливается только по специальной заявке. Срок поставки: 30 дней.

PER IL GRADINO NON SI GARANTISCE LA STESSA TONALITÀ DEL FONDO.

We cannot guarantee that the shade of the stair tile will be the same as the background tile.

Pour la marche, nous ne garantissons pas la même tonalité du fond.

Für die Stufe wird nicht der gleiche Farbton der Grundfliese garantiert.

Para el peldaño no se garantiza el mismo tono del fondo.

Для ступени не гарантирована одинаковость тона с фоном.

# PIERRES DES CHÂTEAUX

8,8 mm RII-C

ANSI A - 137.1: 2012  
WET DYNAMIC COEFFICIENT OF FRICTION | DCOF ≥ 0,42



100x100  
40"x40"  
Nat. Ret.

CHENONCEAU		-
CHEVERNY		158006
CHAMBORD		158007
FONTAINEBLEAU		158009
USSÉ		158008
PREZZO PRICE		€ 46,00 m <sup>2</sup>
CODICE PREZZO PRICE CODE		M109
		<b>Pallet speciale con sponde 103x123x60H</b>
IMBALLO cm h. PACKING cm h.		75
	x	2
m <sup>2</sup>	x	2
Kg	x	36,68
	x	24
m <sup>2</sup>	x	48,00
Kg	x	925













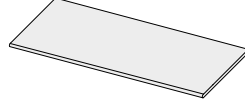



INDOOR  
Floor  
Chambord 100x100 (40"x40") Nat. Ret.

OUTDOOR  
Floor  
Chambord 60x100 (24"x40") Nat. Ret. RII 20 mm

# PIERRES DES CHÂTEAUX

20 mm RII-C

ANSI A - 137.1: 2012  
WET DYNAMIC COEFFICIENT OF FRICTION | DCOF ≥ 0,42

		60x100 24"x40" Nat. Ret.	
		60x100 24"x40" C	Gradone bordo 60 Large step 60
CHENONCEAU		I58035	I58405
CHEVERNY		I58031	I58401
CHAMBORD		I58032	I58402
FONTAINEBLEAU		I58034	I58404
USSÉ		I58033	I58403
	PREZZO PRICE	€ 68,00 m <sup>2</sup>	€ 116,00 PZ/PCE
	CODICE PREZZO PRICE CODE	M135	P183
		Pallet special senza sponde 103x123	Pallet special senza sponde 103x123
	IMBALLO cm h. PACKING cm h.	75	-
	 x 	1	1
	m <sup>2</sup> x 	0,6	-
	Kg x 	22,01	22,01
	 x 	48	-
	m <sup>2</sup> x 	28,8	-
	Kg x 	1091	-

  
Costa toro.  
Bullnose edge.  
Bord boudin.  
Abgerundete Kante.  
Canto redondo  
Закругленная кромка



ATTENZIONE: PER PARTICOLARI INSTALLAZIONI POTREBBERO ESSERE NECESSARI ARTICOLI ED ACCESSORI SPECIFICI NON PRESENTI IN QUESTO CATALOGO. PER QUESTE ESIGENZE PREGO RIFERIRSI DIRETTAMENTE AL REFERENTE COMMERCIALE LA FABBRICA.

N.B. Particular items and accessories not listed in this catalogue may be required for certain laying methods. For these needs, please contact the La Fabbrica sale sales directly.

ATTENTION: Pour les installations particulières, certains articles et accessoires particuliers qui ne sont pas indiqués dans ce catalogue pourraient être nécessaires. Dans ces cas-là, nous vous prions de vous référer directement à la référence commerciale La Fabbrica.

ACHTUNG: Für besondere Installationen können besondere Artikel oder Sonderzubehör notwendig sein, die nicht im vorliegenden Katalog aufgeführt sind. Wenden Sie sich bitte in diesen Fällen direkt an den Vertrieb von La Fabbrica.

ATENCIÓN: para instalaciones particulares podrían requerirse artículos y accesorios específicos que no están presentes en este catálogo. Para tales casos rogamos contactar directamente al representante comercial de La Fabbrica.

ВНИМАНИЕ: Для особых применений могут быть необходимы специальные артикулы и аксессуары, не представленные в данном каталоге. По поводу этих вопросов просим вас обращаться непосредственно к менеджеру коммерческого отдела компании La Fabbrica.

Fontainebleau 60x100 (24"x40") Nat. Ret. RII 20 mm

Floor





Wall: Decoro Perso Muretto Gryphea 24,5x49 (9 1/2"x19 1/2") Lap. Ret. | Floor: Gryphea 60x60 (24"x24") Lap. Ret.

# PIETRA LAVICA

GRES PORCELLANATO COLORATO IN MASSA . COLORED BODY PORCELAIN STONEWARE  
 GRÈS CÉRAMÉ COLORÉ DANS LA MASSE . EINGEFÄRBTES FEINSTEINZEUG  
 GRES PORCELÁNICO COLOREADO EN MASA . КЕРАМОГРАНИТ ОКРАШЕННЫЙ В МАССЕ  
 ISO 13006 - G - B1a (E ≤ 0,5%) - UNI EN 14411 - G

FLOOR TILE OF THE YEAR 2013

100% DESIGN AND PRODUCTION OF ITALY

V2 SHADE SPECTRUM MODERATE

## INDOOR

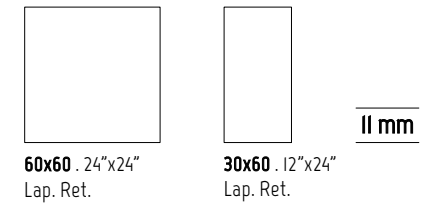

— modular system —

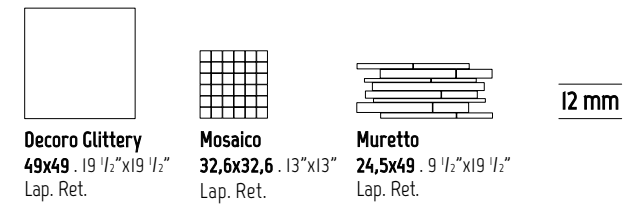

SVILUPPO GRAFICO PER FORMATO Pattern by size Développement graphique par format Grafischer Entwurf für Format Desarrollo gráfico por formato Варианты графики для каждого формата	60x60 11 mm	30x60 11 mm
	1	2

# PIETRA LAVICA

## GRYPHEA

INDOOR

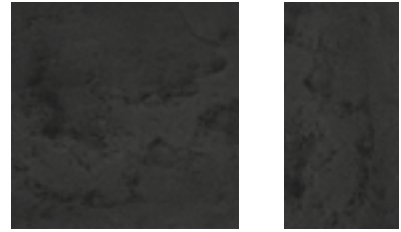

11 mm

**6L84**  
60x60 . 24"x24"  
Lap. Ret.

**VL84**  
30x60 . 12"x24"  
Lap. Ret.

modular system



12 mm

**9324**  
Mosaico  
32,6x32,6 . 13"x13"  
Lap. Ret.

**L811**  
Muretto Gryphea  
24,5x49 . 9 1/2"x19 1/2"  
Lap. Ret.

## DANAE

INDOOR

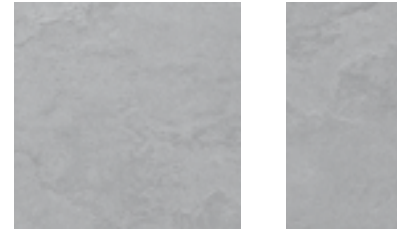

11 mm

**6L85**  
60x60 . 24"x24"  
Lap. Ret.

**VL85**  
30x60 . 12"x24"  
Lap. Ret.

modular system

## EOS

INDOOR



11 mm

**6L81**  
60x60 . 24"x24"  
Lap. Ret.

**VL81**  
30x60 . 12"x24"  
Lap. Ret.

## NEBULA

INDOOR

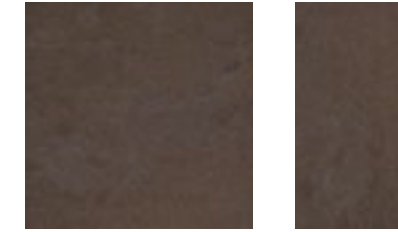

11 mm

**6L82**  
60x60 . 24"x24"  
Lap. Ret.

**VL82**  
30x60 . 12"x24"  
Lap. Ret.

modular system

## FULIGO

INDOOR

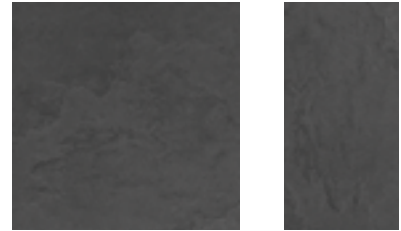

11 mm

**6L83**  
60x60 . 24"x24"  
Lap. Ret.

**VL83**  
30x60 . 12"x24"  
Lap. Ret.

modular system

## ARCADIA

INDOOR



11 mm

**6L86**  
60x60 . 24"x24"  
Lap. Ret.

**VL86**  
30x60 . 12"x24"  
Lap. Ret.

modular system

## ARENAL

INDOOR

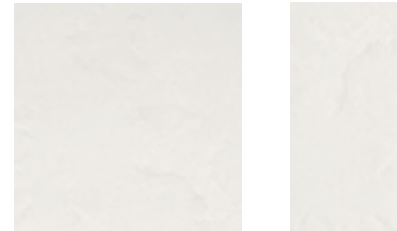

11 mm

**6L80**  
60x60 . 24"x24"  
Lap. Ret.

**VL80**  
30x60 . 12"x24"  
Lap. Ret.

modular system



12 mm

**9320**  
Mosaico  
32,6x32,6 . 13"x13"  
Lap. Ret.

**L807**  
Muretto Arenal  
24,5x49 . 9 1/2"x19 1/2"  
Lap. Ret.

## DECORO GLITTERY

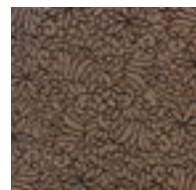

















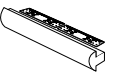
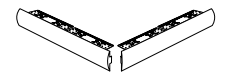
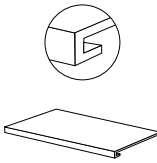
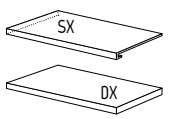



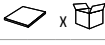

12 mm

**L650**  
Diamond Glittery  
49x49 . 19 1/2"x19 1/2"  
Lap. Ret.

# PIETRA LAVICA

11 mm

ANSI A - 137.1: 2012  
WET DYNAMIC COEFFICIENT OF FRICTION | DCOF ≥ 0,42

	modular system		Decoro Diamond Glittery Diamond Glittery decorative tile	Mosaico Mosaic	Muretto Brick-effect mosaic	Battiscopa Skirting	Torello per gradino Bullnose for step/stair	Torello per angolo gradino Bullnose for step/stair	Gradino costa retta Straight-edge step **	Gradino costa retta - Angolo SX / DX Straight-edge step - LH/RH corner **	
	 60x60 24"x24" Lap. Ret.	 30x60 12"x24" Lap. Ret.	 49x49 19 1/2"x19 1/2" Lap. Liscia Ret. 12 mm	 30x30 12"x12" Lap. Ret. 12 mm	 24,5x49 9 1/2"x19 1/2" Lap. Ret. 12 mm	 9,5x60 3 3/4"x24" Lap. Ret.	 4x60 1 1/2"x24" Lap. Ret.	 4x60 1 1/2"x24" Lap. Ret.	 33x60x3,2h 13"x24"x1 1/4"h Lap. Ret.	 33x60x3,2h 13"x24"x1 1/4"h Lap. Ret.	
GRYPHEA 	6L84	VL84	L650	9324	L811	BL84	K614		J614	K57L10A	J57L10S SX J57L100 DX
FULIGO 	6L83	VL83		-	-	BL83	K613		J613	K57L08A	J57L08S SX J57L080 DX
ARCADIA 	6L86	VL86		-	-	BL87	K616		5616	K57L12A	J57L12S SX J57L120 DX
DANEA 	6L85	VL85		-	-	BL85	K615		5615	K57L11A	J57L11S SX J57L110 DX
EOS 	6L81	VL81		-	-	BL81	K611		J611	K57L04A	J57L04S SX J57L040 DX
ARENAL 	6L80	VL80		9320	L807	BL80	K610		J610	K57L02A	J57L02S SX J57L020 DX
NEBULA 	6L82	VL82		-	-	BL82	K612		J612	K57L06A	J57L06S SX J57L060 DX
PREZZO PRICE	€ 64,00 m <sup>2</sup>	€ 64,00 m <sup>2</sup>	€ 120,00 m <sup>2</sup>	€ 120,00 m <sup>2</sup>	€ 134,00 m <sup>2</sup>	€ 6,00 PZ/PCE	€ 40,00 PZ/PCE		€ 90,00 PZ/PCE	€ 76,00 PZ/PCE	€ 106,00 PZ/PCE
CODICE PREZZO PRICE CODE	M131	M131	P187	M187	M201	P021	P097		P157	P143	P173
	<b>Epal</b> 80x120	<b>Epal</b> 80x120	<b>Epal</b> 80x120	<b>Epal</b> 80x120	<b>Epal</b> 80x120	<b>Epal</b> 80x120	<b>Epal</b> 80x120		<b>Epal</b> 80x120	<b>Epal</b> 80x120	<b>Epal</b> 80x120
IMBALLO cm h. PACKING cm h.	75	75	-	75	65	-	-		-	-	-
 x 	3	6	2	5	4	12	4		2	4	4
m <sup>2</sup> x 	1,08	1,08	-	0,53	0,48	-	-		-	-	-
Kg x 	26,00	27,00	12	12,70	6,00	18,00	3,00		3,00	24,00	26,00
 x 	32	40	-	60	50	-	-		-	-	-
m <sup>2</sup> x 	34,56	43,20	-	31,80	24,00	-	-		-	-	-
Kg x 	841	1.100	-	782	320	-	-		-	-	-

SI CONSIGLIA FORTEMENTE DI PULIRE BENE LA SUPERFICIE DELLE PIASTRELLE STRUTTURATE IMMEDIATAMENTE DOPO AVER FUGATO IL PAVIMENTO. QUESTA OPERAZIONE EVITERÀ AL MATERIALE USATO PER LA FUGA DI SOLIDIFICARSI ALL'INTERNO DELLE CAVITÀ PRESENTI NELLA SUPERFICIE DELLA PIASTRELLA.

We strongly recommend you thoroughly clean the surface of textured floor tiles immediately after filling the joints. This will prevent the filler solidifying in the cavities found in the tiles' surface.

Il est vivement recommandé de bien nettoyer la surface des carreaux structurés, immédiatement après le jointoyage. Cette opération empêchera le matériel utilisé pour le jointoyage de se solidifier à l'intérieur des cavités présentes à la surface des carreaux.

Es wird dringend geraten, die Oberfläche der strukturierten Fliesen sofort nach dem Verfugen des Bodenbelags gut zu reinigen. Dieser Vorgang verhindert, dass das zum Verfugen verwendete Material innerhalb der in der Fliesenoberfläche vorhandenen Hohlräume aushärten kann.

Настоятельно рекомендуем хорошо очистить поверхность структурированной плитки сразу же после заделки швов на полу. Таким образом, используемый для заделки швов материал не отвердеет в неровностях, имеющихся на поверхности плитки.

ATTENZIONE: LE ZONE PIÙ SCUERE/CHIARE (FOTO) SONO DERIVATE DALLA LUCIDATURA DELLE CRESTE E SONO UN EFFETTO VOLUTO MIRANTE AD ESALTARNE LA PARTICOLARITÀ DELLA STRUTTURA.

N.B. Polishing generates lighter/darker areas (photo); this is an intentional effect to enhance the particular features of the structure.

ATTENTION: Les zones plus foncées/clairées (photo) sont dues au polissage des crêtes; cet effet voulu a pour but d'exalter la particularité de la structure.

ACHTUNG: Diese helleren/dunkleren Bereiche (Foto) entstehen beim Polieren der Wülste und sind ein erwünschter Effekt, durch den die Besonderheit der Struktur hervorgehoben werden soll.

ATENCIÓN: Las zonas más oscuras/claras (foto) son consecuencia del abrillantado de las crestas y se obtienen como efecto deliberado tendiente a destacar la particularidad de la estructura.

ВНИМАНИЕ: Более светлые и темные части (см. фотографию) образуются в результате полировки выступов, и они специально создаются для подчеркивания особенности структуры.

\*\* A DISPOSIZIONE SOLO SU RICHIESTA. TEMPI DI CONSEGNA: 30GG.

Available upon request only. Delivery terms: 30 days.

Disponible seulement sur requête. Délais de livraison: 30 jours.

Verfügbar auf Anfrage. Lieferzeit: 30 Tage.

Disponible sólo bajo pedido. Plazo de entrega: 30 días.

Изготавливается только по специальной заявке. Срок поставки: 30 дней.

PER IL GRADINO NON SI GARANTISCE LA STESSA TONALITÀ DEL FONDO.

We cannot guarantee that the shade of the stair tile will be the same as the background tile.

Pour la marche, nous ne garantissons pas la même tonalité du fond.

Für die Stufe wird nicht der gleiche Farbton der Grundfliese garantiert.

Para el peldaño no se garantiza el mismo tono del fondo.

Для ступени не гарантирована одинаковость тона с фоном.



GOLD



INDOOR - Wall: Mosaico Gold 30x30 (12"x12") Nat.Ret. / Floor: Gold 60x120 (24"x48") Nat.Ret. - Gold 60x60 (24"x24") Nat.Ret. - Gold 30x60 (12"x24") Nat.Ret.

GRES PORCELLANATO COLORATO IN MASSA . COLORED BODY PORCELAIN STONEWARE  
 GRÈS CÉRAMÉ COLORÉ DANS LA MASSE . EINGEFÄRBTES FEINSTEINZEUG  
 GRES PORCELÁNICO COLOREADO EN MASA . КЕРАМОГРАНИТ ОКРАШЕННЫЙ В МАССЕ  
 ISO 13006 - G - B1a (E ≤ 0,5%) - UNI EN 14411 - G

100% DESIGN  
AND PRODUCTION  
OF ITALY



INDOOR

R10-A

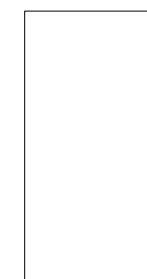

60x120 . 24"x48"  
Nat. Ret.



60x60 . 24"x24"  
Nat. Ret.

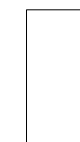

30x60 . 12"x24"  
Nat. Ret.

30,5x60,5 . 12"x24"  
Nat.



Mosaico  
30x30 . 12"x12"  
Nat. Ret.

10 mm

modular system

OUTDOOR

R11-C



60x60 . 24"x24"  
Nat. Ret.

20 mm

SVILUPPO GRAFICO PER FORMATO  
 Pattern by size  
 Développement graphique par format  
 Grafischer Entwurf für Format  
 Desarrollo gráfico por formato  
 Варианты графики для каждого формата

60x120	60x60	30x60	30,5x60,5
10 mm	10 mm 20 mm	10 mm	10 mm
20	40	78	78

# ROYAL STONE

## GOLD

INDOOR

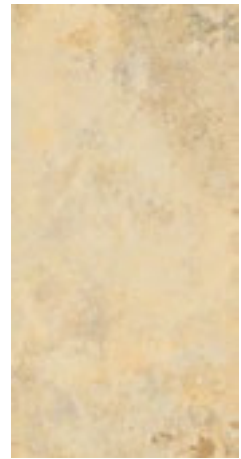

10 mm R10-A

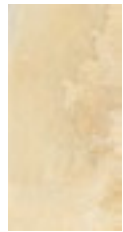
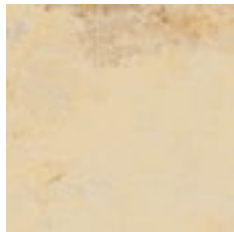

**I22001**  
60x120 . 24"x48"  
Nat. Ret.

**I22005**  
60x60 . 24"x24"  
Nat. Ret.

**I22010**  
30x60 . 12"x24"  
Nat. Ret.

**I22015**  
Mosaico  
30x30 . 12"x12"  
Nat. Ret.

**I22008**  
30,5x60,5 . 12"x24"  
Nat.

modular system

## OUTDOOR

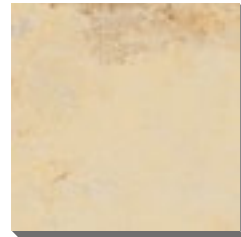

20 mm R11-C

**I22007**  
60x60 . 24"x24"  
Nat. Ret.

















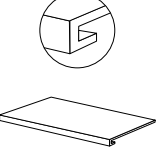
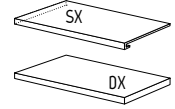

Wall  
Mosaico Gold 30x30 (12"x12") Nat. Ret.

Floor  
Gold 60x120 (24"x48") Nat. Ret.  
Gold 60x60 (24"x24") Nat. Ret.  
Gold 30x60 (12"x24") Nat. Ret.

# ROYAL STONE

10 mm RIO-A

ANSI A - 137.1: 2012  
WET DYNAMIC COEFFICIENT OF FRICTION | DCOF ≥ 0,42

	modular system				Mosaico Mosaic	Battiscopa Skirting	Gradino costa retta Straight-edge step **	Gradino costa retta - Angolo SX / DX Straight-edge step - LH/RH corner **
	 60x120* 24"x48" Nat. Ret.	 60x60 24"x24" Nat. Ret.	 30x60 12"x24" Nat. Ret.	 30,5x60,5 12"x24" Nat.	 30x30 12"x12" Nat. Ret.	 9,5x60 2 1/2"x48" Nat. Ret.	 33x60x3,2h 13"x24"xl 1/4" Nat. Ret.	 33x60x3,2h 13"x24"xl 1/4" Nat. Ret.
GOLD 	I22001	I22005	I22010	I22008	I22015	I22020	I22030	I22032 SX I22031 DX
PREZZO PRICE	€ 40,00 m <sup>2</sup>	€ 33,00 m <sup>2</sup>	€ 32,00 m <sup>2</sup>	€ 24,00 m <sup>2</sup>	€ 68,00 m <sup>2</sup>	€ 5,00 PZ/PCE	€ 68,00 PZ/PCE	€ 84,00 PZ/PCE
CODICE PREZZO PRICE CODE	M097	M083	M081	M065	M135	P017	P135	P151
	<b>Epal</b> 80x120	<b>Epal</b> 80x120	<b>Epal</b> 80x120	<b>Epal</b> 80x120	<b>Epal</b> 80x120	<b>Epal</b> 80x120	<b>Epal</b> 80x120	<b>Epal</b> 80x120
IMBALLO cm h. PACKING cm h.	75	75	75	75	75	-	-	-
 x 	2	3	6	8	6	12	4	2
m <sup>2</sup> x 	1,44	1,08	1,08	1,48	0,54	-	-	-
Kg x 	30,96	22,68	21,60	33,00	12,15	14,50	23,00	13,00
 x 	32	40	40	32	54	-	-	-
m <sup>2</sup> x 	46,08	43,20	43,20	47,36	23,16	-	-	-
Kg x 	1.011	927	884	1.076	676	-	-	-

Floor  
Gold 60x120 (24"x48") Nat. Ret.



\* NUOVA PALLETIZZAZIONE DISPONIBILE (AD ESAURIMENTO DELLO STOCK ESISTENTE).  
New pallet configuration (once current stock fully exhausted). -  
Nouvelle palettisation disponible (jusqu'à épuisement du stock existant).  
Neue Palettierung verfügbar (solange der Vorrat reicht). - Nueva paletización disponible (al agotarse las actuales existencias).  
Новые поддоны будут доступны (после расходования существующих запасов).









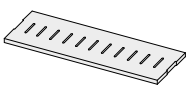
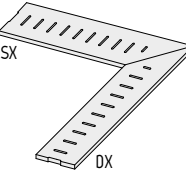
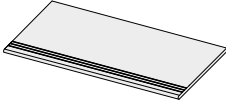
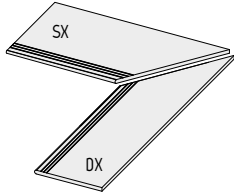
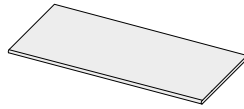
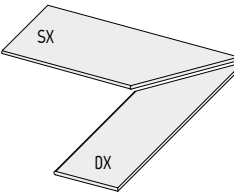

\*\* A DISPOSIZIONE SOLO SU RICHIESTA. TEMPI DI CONSEGNA: 30GG.  
Available upon request only. Delivery terms: 30 days.  
Disponible seulement sur requête. Délais de livraison: 30 jours.  
Verfügbar auf Anfrage. Lieferzeit: 30 Tage.  
Disponibile sólo bajo pedido. Plazo de entrega: 30 días.  
Изготавливается только по специальной заявке. Срок поставки: 30 дней.

PER IL GRADINO NON SI GARANTISCE LA STESSA TONALITÀ DEL FONDO.  
We cannot guarantee that the shade of the stair tile will be the same as the background tile.  
Pour la marche, nous ne garantissons pas la même tonalité du fond.  
Für die Stufe wird nicht der gleiche Farbton der Grundfliese garantiert.  
Para el peldaño no se garantiza el mismo tono del fondo.  
Для ступени не гарантирована одинаковость тона с фоном.

# ROYAL STONE

20 mm RII-C

ANSI A - 137.1: 2012  
WET DYNAMIC COEFFICIENT OF FRICTION | DCOF ≥ 0,42

																			
	60x60 24"x24" Nat. Ret.	15x60 6"x24"	30x60 12"x24"	15x60 6"x24"	30x60 12"x24"	30x60 12"x24"	30x60 12"x24"	30x60 12"x24"	15x60 6"x24"	30x60 12"x24"	30x60 12"x24"	30x60 12"x24"	15x60 6"x24"	30x60 12"x24"	30x60 12"x24"	30x60 12"x24"			
																			
	PREZZO PRICE	€ 50,00 m <sup>2</sup>	€ 128,00 PZ/PCE	€ 150,00 PZ/PCE	€ 128,00 PZ/PCE	€ 150,00 PZ/PCE	€ 70,00 PZ/PCE	€ 60,00 PZ/PCE	€ 90,00 PZ/PCE	€ 78,00 PZ/PCE	€ 60,00 PZ/PCE	€ 50,00 PZ/PCE	€ 60,00 PZ/PCE	€ 50,00 PZ/PCE	€ 78,00 PZ/PCE	€ 70,00 PZ/PCE	€ 78,00 PZ/PCE	€ 70,00 PZ/PCE	
	CODICE PREZZO PRICE CODE	M117	P195	P217	P195	P217	P137	P127	P157	P145	P127	P117	P127	P117	P145	P137	P145	P137	
	Imballo Epal 80x120																		
	IMBALLO cm h. PACKING cm h.	75	-	-	-	-	-	-	-	-	-	-	-	-	-	-	-	-	
	 x 	2	1	1	1	1	1	1	1	1	1	1	1	1	1	1	1	1	
	m <sup>2</sup> x 	0,72	-	-	-	-	-	-	-	-	-	-	-	-	-	-	-	-	
	Kg x 	31,00	4,20	8,40	3,60	7,20	9,00	6,60	4,50	9,00	3,80	6,60	3,80	6,60	3,80	6,60	3,80		
	 x 	30	-	-	-	-	-	-	-	-	-	-	-	-	-	-	-	-	
	m <sup>2</sup> x 	21,60	-	-	-	-	-	-	-	-	-	-	-	-	-	-	-	-	
	Kg x 	938	-	-	-	-	-	-	-	-	-	-	-	-	-	-	-	-	

IL PESO DEI PEZZI SPECIALI 20 MM INDICATO IN TABELLA SI RIFERISCE AL PESO DEL SINGOLO PEZZO. PER CALCOLARE IL PESO COMPLESSIVO DEL MATERIALE IMBALLATO OCCORRERÀ AGGIUNGERE AL PESO IN TABELLA IL PESO DELL'IMBALLO E DELLA PALETTA (PESO VARIABILE DA 10 A 30 KG IN FUNZIONE DELLA QUANTITÀ E DELLA TIPOLOGIA DEI PEZZI SPECIALI RICHIESTI).

The weight of the 20 mm TRIMS stated in the table refers to the weight of each trim. To calculate the total weight of the packed material, you will need to add the combined weight of the packing materials and the pallet (weight ranging from 10 to 30kg depending on the quantity and the type of the TRIMS required) to the weight stated in the table.

Le poids des PIÈCES SPÉCIALES 20 mm indique dans le tableau se réfère au poids individuel de chaque pièce. Pour calculer le poids total du matériel emballé, il faudra ajouter au poids indiqué dans le tableau le poids de l'emballage et de la palette (poids variable de 10 à 30 kg en fonction de la quantité et du type de PIÈCES SPÉCIALES demandées).

Das in der Tabelle angegebene Gewicht der 20 mm-SONDERTEILE bezieht sich auf das Gewicht des Einzelteils. Zur Berechnung des Gesamtgewichts des verpackten Materials muss zum in der Tabelle aufgeführten Wert das Gewicht der Verpackung und der Palette (von 10 bis 30 kg variierbar in Abhängigkeit von der Menge und Art der gewünschten SONDERTEILE) dazugerechnet werden.

El peso de las PIEZAS ESPECIALES 20 mm indicado en la tabla se refiere al peso de cada pieza singularmente considerada. Para calcular el peso total del material embalado se deberá agregar al peso según la tabla, el peso del embalaje y del palet (peso variable entre 10 y 30 kg en función de la cantidad y tipo de las PIEZAS ESPECIALES requeridas).

Указанный в таблице вес СПЕЦИАЛЬНЫХ ИЗДЕЛИЙ 20 мм - это вес каждого отдельного изделия. Для расчета общего веса упакованного материала необходимо добавить к указанному в таблице значению вес упаковки и поддона (вес может составлять от 10 до 30 кг, в зависимости от количества и типа заказанных СПЕЦИАЛЬНЫХ ИЗДЕЛИЙ).



**Costa toro.**  
Bullnose edge.  
Bord boudin.  
Abgerundete Kante.  
Canto redondo  
Закругленная кромка



**Costa retta.**  
Straight edge.  
Bord droit.  
Gerade Kante.  
Canto recto  
Прямоугольная кромка

**ATTENZIONE:** Per particolari installazioni potrebbero essere necessari articoli ed accessori specifici non presenti in questo catalogo. Per queste esigenze prego riferirsi direttamente al referente commerciale La Fabbrica.

N.B. Particular items and accessories not listed in this catalogue may be required for certain laying methods. For these needs, please contact the La Fabbrica sales directly.

ATTENTION : Pour les installations particulières, certains articles et accessoires particuliers qui ne sont pas indiqués dans ce catalogue pourraient être nécessaires. Dans ces cas-là, nous vous prions de vous référer directement à la référence commerciale La Fabbrica.

ACHTUNG: Für besondere Installationen können besondere Artikel oder Sonderzubehör notwendig sein, die nicht im vorliegenden Katalog aufgeführt sind. Wenden Sie sich bitte in diesen Fällen direkt an den Vertrieb von La Fabbrica.

ATENCIÓN: para instalaciones particulares podrían requerirse artículos y accesorios específicos que no están presentes en este catálogo. Para tales casos rogamos contactar directamente al representante comercial de La Fabbrica.

ВНИМАНИЕ: Для особых применений могут быть необходимы специальные артикулы и аксессуары, не представленные в данном каталоге. По поводу этих вопросов просим вас обращаться непосредственно к менеджеру коммерческого отдела компании La Fabbrica.

# ROYAL STONE

20 mm RII-C

ANSI A - 137.1: 2012  
WET DYNAMIC COEFFICIENT OF FRICTION | DCOF ≥ 0,42

	Gradone bordo svasato Large step with rounded border		Gradone bordo svasato - Angolo SX / DX Large step with rounded border - Corner SX / DX		Canalina Channel	Canalina - Angolo SX / DX Channel - Corner SX / DX	Cordolo U-Border	Cordolo - Angolo SX / DX U-Border - Corner SX / DX
	30x60 12"x24"	30x60 12"x24"	30x60 12"x24"	30x60 12"x24"	15x60x8h 6"x24"x3"h	15x60x8h 6"x24"x3"h	15x60x15h 6"x24"x6"h	15x60x15h 6"x24"x6"h
GOLD	I22258	I22253	I22257 SX I22256 DX	I22255 SX I22254 DX	I22232	I22234 SX I22233 DX	I22201	I22203 SX I22202 DX
PREZZO PRICE	€ 130,00 PZ/PCE	€ 114,00 PZ/PCE	€ 152,00 PZ/PCE	€ 138,00 PZ/PCE	€ 90,00 PZ/PCE	€ 108,00 PZ/PCE	€ 110,00 PZ/PCE	€ 134,00 PZ/PCE
CODICE PREZZO PRICE CODE	P197	P181	P219	P205	P157	P175	P177	P201
	Epal 80x120		Epal 80x120		Epal 80x120	Epal 80x120	Epal 80x120	Epal 80x120
IMBALLO cm h. PACKING cm h.	-		-		-	-	-	-
	1		1		1	1	1	1
m <sup>2</sup> x	-		-		-	-	-	-
Kg x	9,00		6,60		8,00	7,00	13,50	11,80
	-		-		-	-	-	-
m <sup>2</sup> x	-		-		-	-	-	-
Kg x	-		-		-	-	-	-

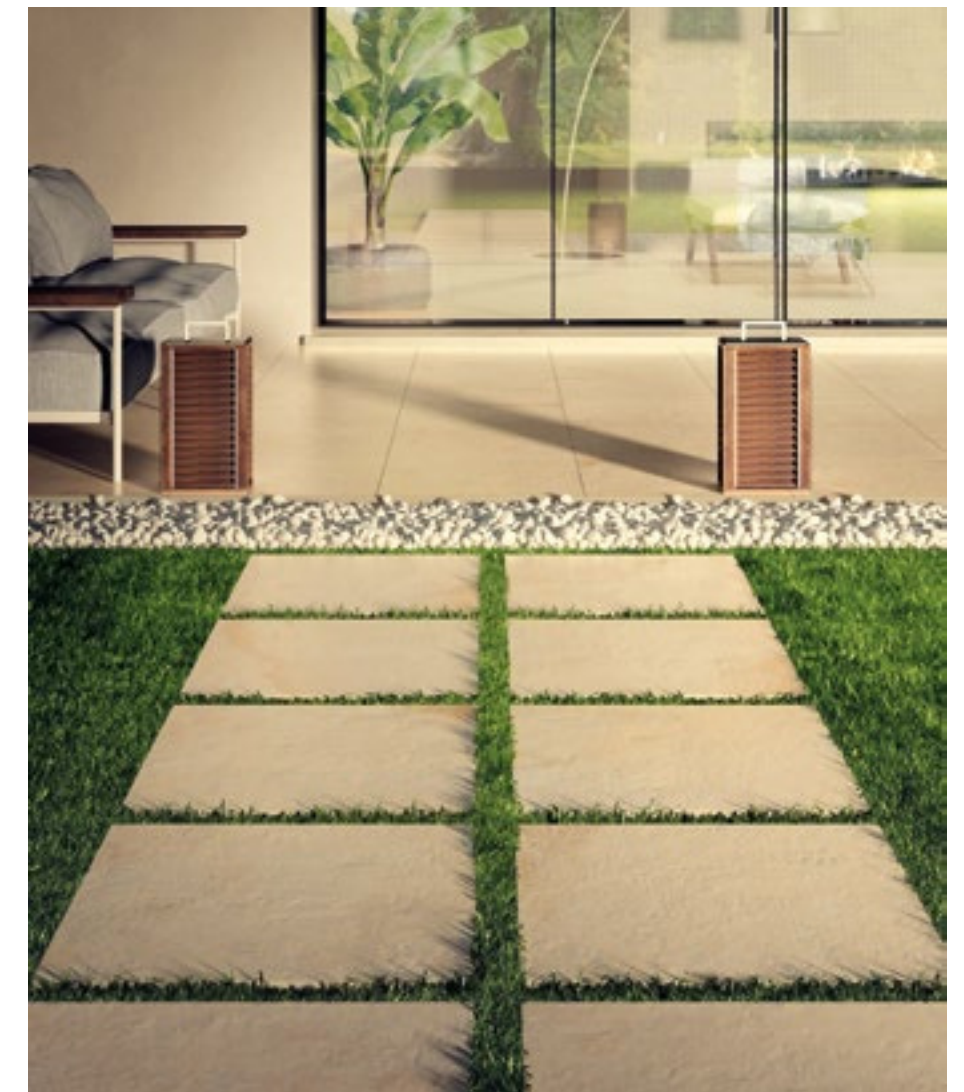

Floor  
Gold 60x60 (24"x24") Nat. Ret. RII 20 mm

IL PESO DEI PEZZI SPECIALI 20 MM INDICATO IN TABELLA SI RIFERISCE AL PESO DEL SINGOLO PEZZO. PER CALCOLARE IL PESO COMPLESSIVO DEL MATERIALE IMBALLATO OCCORRERÀ AGGIUNGERE AL PESO IN TABELLA IL PESO DELL'IMBALLO E DELLA PALETTA (PESO VARIABILE DA 10 A 30 KG IN FUNZIONE DELLA QUANTITÀ E DELLA TIPOLOGIA DEI PEZZI SPECIALI RICHIESTI).

The weight of the 20 mm TRIMS stated in the table refers to the weight of each trim. To calculate the total weight of the packed material, you will need to add the combined weight of the packing materials and the pallet (weight ranging from 10 to 30kg depending on the quantity and the type of the TRIMS required) to the weight stated in the table.

Le poids des PIÈCES SPECIALES 20 mm indiqué dans le tableau se réfère au poids individuel de chaque pièce. Pour calculer le poids total du matériel emballé, il faudra ajouter au poids indiqué dans le tableau le poids de l'emballage et de la palette (poids variable de 10 à 30 kg en fonction de la quantité et du type de PIÈCES SPECIALES demandées).

Das in der Tabelle angegebene Gewicht der 20 mm-SONDERTEILE bezieht sich auf das Gewicht des Einzeiteils. Zur Berechnung des Gesamtgewichts des verpackten Materials muss zum in der Tabelle aufgeführten Wert das Gewicht der Verpackung und der Palette (von 10 bis 30 kg variierbar in Abhängigkeit von der Menge und Art der gewünschten SONDERTEILE) dazugerechnet werden.

El peso de las PIEZAS ESPECIALES 20 mm indicado en la tabla se refiere al peso de cada pieza singularmente considerada. Para calcular el peso total del material embalado se deberá agregar al peso según la tabla, el peso del embalaje y del palet (peso variable entre 10 y 30 kg en función de la cantidad y tipo de las PIEZAS ESPECIALES requeridas).

Указанный в таблице вес СПЕЦИАЛЬНЫХ ИЗДЕЛИЙ 20 мм - это вес каждого отдельного изделия. Для расчета общего веса упакованного материала необходимо добавить к указанному в таблице значению вес упаковки и поддона (вес может составлять от 10 до 30 кг, в зависимости от количества и типа заказанных СПЕЦИАЛЬНЫХ ИЗДЕЛИЙ).



**Costa toro.**  
Bullnose edge.  
Bord boudin.  
Abgerundete Kante.  
Canto redondo  
Закругленная кромка



**Costa retta.**  
Straight edge.  
Bord droit.  
Gerade Kante.  
Canto recto  
Прямоугольная кромка

**ATTENZIONE:** Per particolari installazioni potrebbero essere necessari articoli ed accessori specifici non presenti in questo catalogo. Per queste esigenze prego riferirsi direttamente al referente commerciale La Fabbrica.

N.B. Particular items and accessories not listed in this catalogue may be required for certain laying methods. For these needs, please contact the La Fabbrica sales directly.

ATTENTION : Pour les installations particulières, certains articles et accessoires particuliers qui ne sont pas indiqués dans ce catalogue pourraient être nécessaires. Dans ces cas-là, nous vous prions de vous référer directement à la référence commerciale La Fabbrica.

ACHTUNG: Für besondere Installationen können besondere Artikel oder Sonderzubehör notwendig sein, die nicht im vorliegenden Katalog aufgeführt sind. Wenden Sie sich bitte in diesen Fällen direkt an den Vertrieb von La Fabbrica.

ATENCIÓN: para instalaciones particulares podrían requerirse artículos y accesorios específicos que no están presentes en este catálogo. Para tales casos rogamos contactar directamente al representante comercial de La Fabbrica.

ВНИМАНИЕ: Для особых применений могут быть необходимы специальные артикулы и аксессуары, не представленные в данном каталоге. По поводу этих вопросов просим вас обращаться непосредственно к менеджеру коммерческого отдела компании La Fabbrica.





INDOOR - Wall: Salt Mosaico 30x30 (12"x12") Nat. Ret. / Floor: Salt 80x80 (31 1/2"x31 1/2") Nat. Ret.  
OUTDOOR - Floor: Salt 80x80 (31 1/2"x31 1/2") 20 mm Nat. Ret. Ret. RII

GRES PORCELLANATO COLORATO IN MASSA . COLORED BODY PORCELAIN STONEWARE  
GRÈS CÉRAMÉ COLORÉ DANS LA MASSE . EINGEFÄRBTES FEINSTEINZEUG  
GRES PORCELÁNICO COLOREADO EN MASA . КЕРАМОГРАНИТ ОКРАШЕННЫЙ В МАССЕ  
ISO 13006 - G - B1a (E ≤ 0,5%) - UNI EN 14411 - G

100% DESIGN  
AND PRODUCTION  
OF ITALY

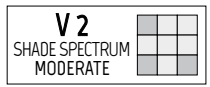

INDOOR

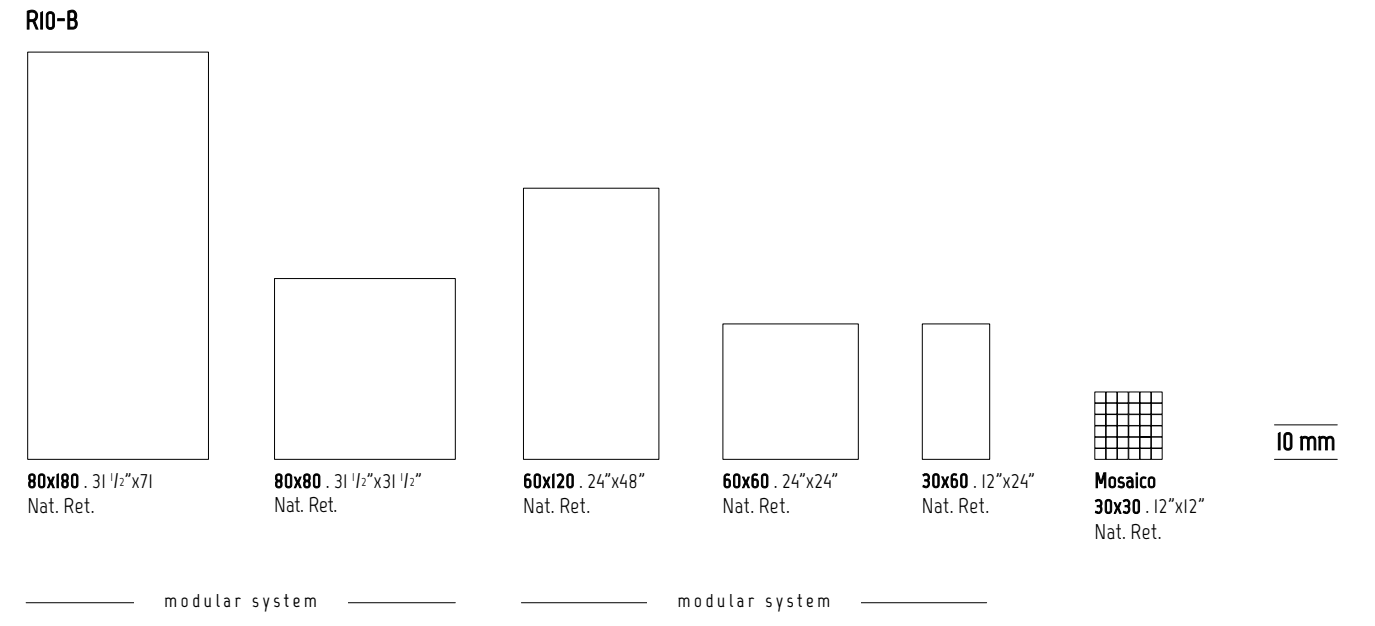

OUTDOOR

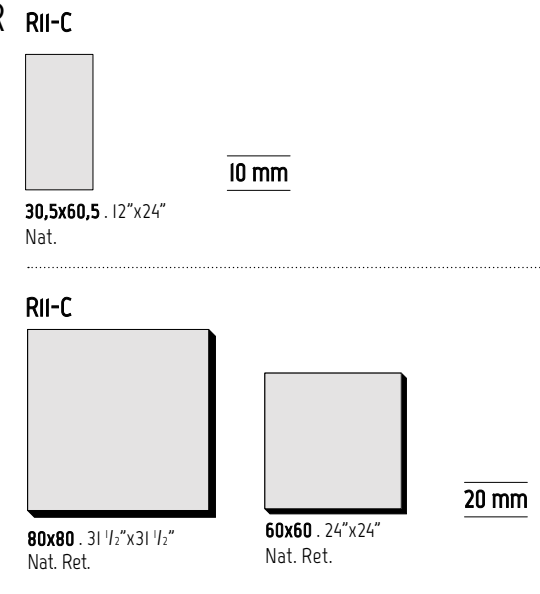

SVILUPPO GRAFICO PER FORMATO Pattern by size Développement graphique par format Grafischer Entwurf für Format Desarrollo gráfico por formato Варианты графики для каждого формата	80x180 10 mm	60x120 10 mm	60x60 10 mm 20 mm	30x60 10 mm	30,5x60,5 10 mm	80x80 10 mm 20 mm
	12	24	52	76	76	24

# STORM

## DARK

INDOOR

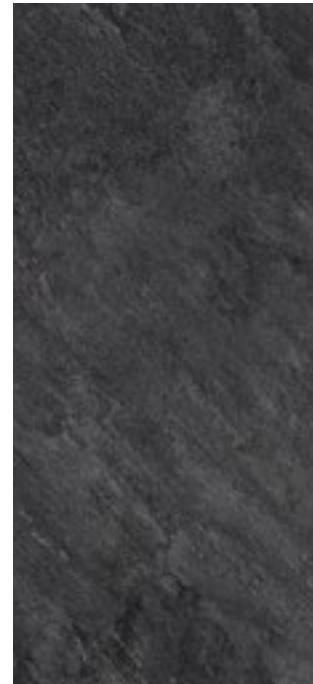

10 mm R10-B

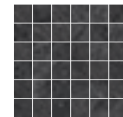
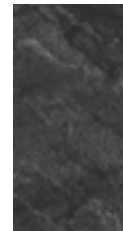
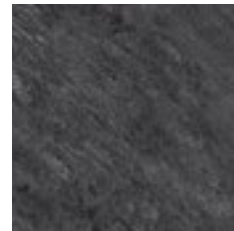

117004  
80x180 . 31 1/2"x71"  
Nat. Ret.

117021  
80x80 . 31 1/2"x31 1/2"  
Nat. Ret.

117013  
60x120 . 24"x48"  
Nat. Ret.

117046  
60x60 . 24"x24"  
Nat. Ret.

117071  
30x60 . 12"x24"  
Nat. Ret.

117093  
Mosaico  
30x30 . 12"x12"  
Nat. Ret.

modular system

modular system

## FOG

INDOOR

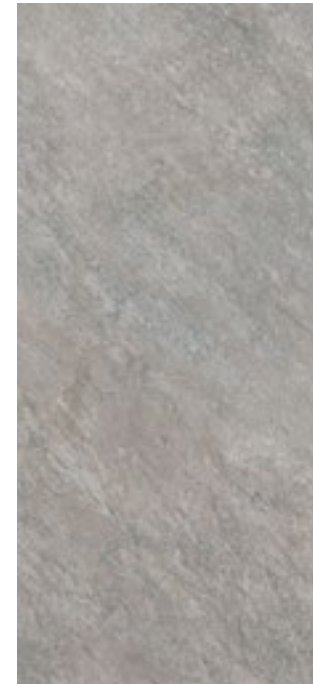

10 mm R10-B

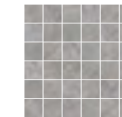
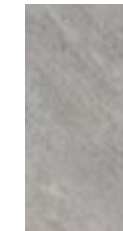
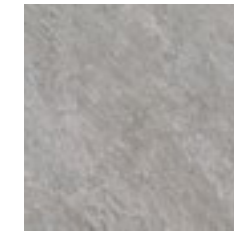
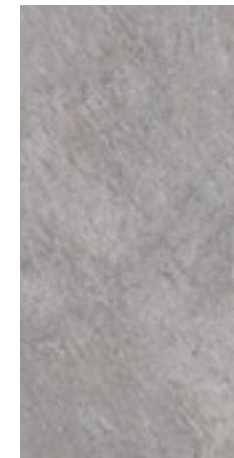
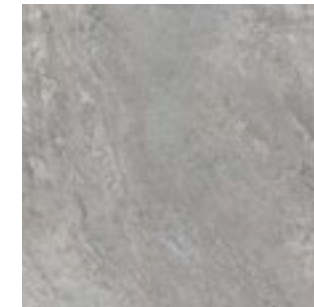

117003  
80x180 . 31 1/2"x71"  
Nat. Ret.

117020  
80x80 . 31 1/2"x31 1/2"  
Nat. Ret.

117012  
60x120 . 24"x48"  
Nat. Ret.

117045  
60x60 . 24"x24"  
Nat. Ret.

117070  
30x60 . 12"x24"  
Nat. Ret.

117092  
Mosaico  
30x30 . 12"x12"  
Nat. Ret.

modular system

modular system

## OUTDOOR

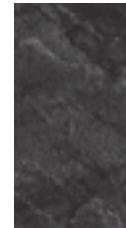

10 mm R11-C

117063  
30,5x60,5 . 12"x24"  
Nat.

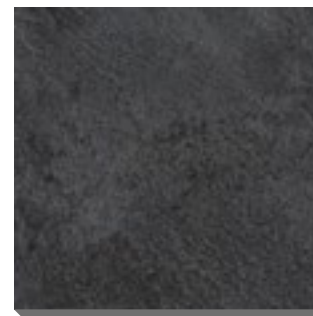

20 mm R11-C

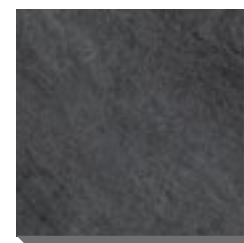

117026  
80x80 . 31 1/2"x31 1/2"  
Nat. Ret.

117051  
60x60 . 24"x24"  
Nat. Ret.

## OUTDOOR



10 mm R11-C

117062  
30,5x60,5 . 12"x24"  
Nat.

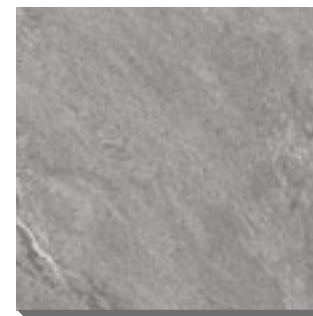

20 mm R11-C

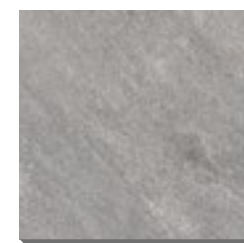

117025  
80x80 . 31 1/2"x31 1/2"  
Nat. Ret.

117050  
60x60 . 24"x24"  
Nat. Ret.

# STORM

## SALT

INDOOR



10 mm R10-B

**117001**  
80x180 . 31 1/2"x71"  
Nat. Ret.



**117018**  
80x80 . 31 1/2"x31 1/2"  
Nat. Ret.

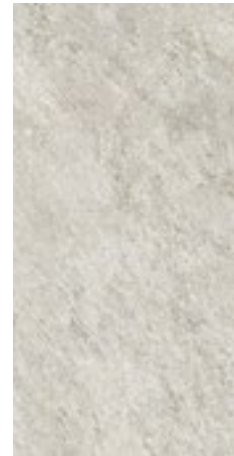

**117010**  
60x120 . 24"x48"  
Nat. Ret.

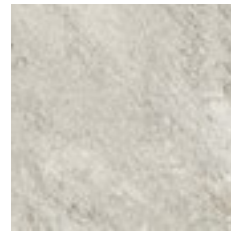

**117043**  
60x60 . 24"x24"  
Nat. Ret.



**117068**  
30x60 . 12"x24"  
Nat. Ret.



**117090**  
Mosaico  
30x30 . 12"x12"  
Nat. Ret.

modular system

modular system

## SAND

INDOOR

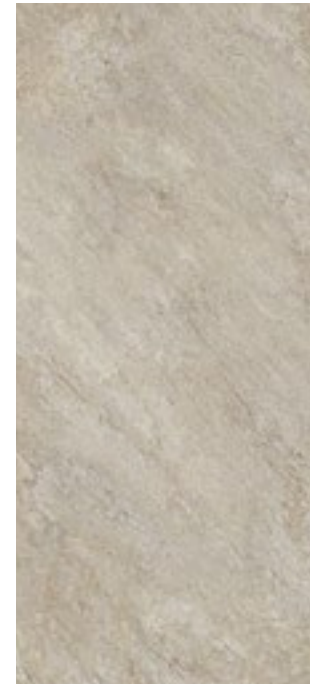

10 mm R10-B

**117002**  
80x180 . 31 1/2"x71"  
Nat. Ret.



**117019**  
80x80 . 31 1/2"x31 1/2"  
Nat. Ret.

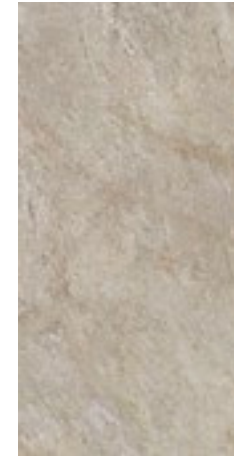

**117011**  
60x120 . 24"x48"  
Nat. Ret.

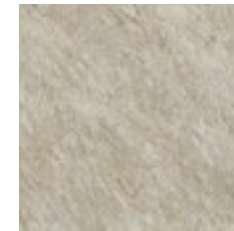

**117044**  
60x60 . 24"x24"  
Nat. Ret.

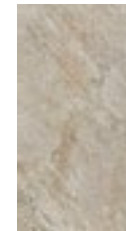

**117069**  
30x60 . 12"x24"  
Nat. Ret.

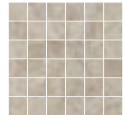

**117091**  
Mosaico  
30x30 . 12"x12"  
Nat. Ret.

modular system

modular system

## OUTDOOR



10 mm R11-C

**117060**  
30,5x60,5 . 12"x24"  
Nat.

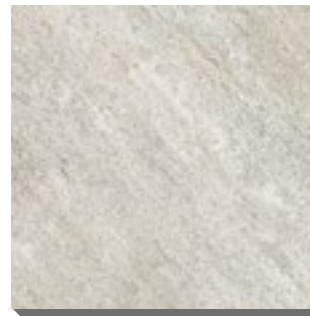

20 mm R11-C

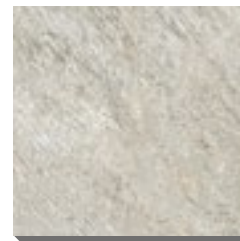

**117023**  
80x80 . 31 1/2"x31 1/2"  
Nat. Ret.

**117048**  
60x60 . 24"x24"  
Nat. Ret.

## OUTDOOR

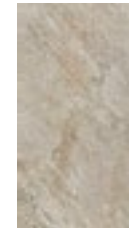

10 mm R11-C

**117061**  
30,5x60,5 . 12"x24"  
Nat.

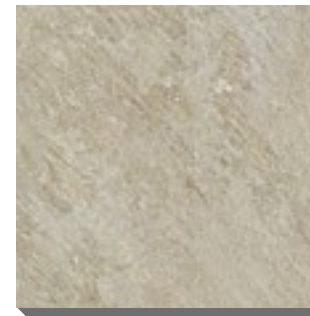

20 mm R11-C

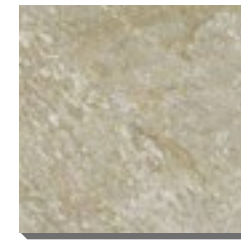











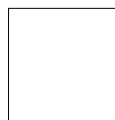
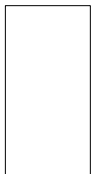



**117024**  
80x80 . 31 1/2"x31 1/2"  
Nat. Ret.

**117049**  
60x60 . 24"x24"  
Nat. Ret.

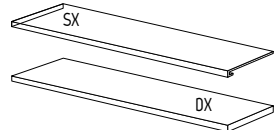
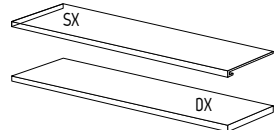
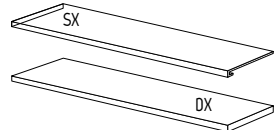
# STORM

10 mm RIO-B

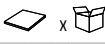
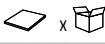
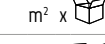
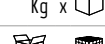
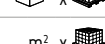
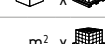
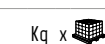
ANSI A - 137.1: 2012  
WET DYNAMIC COEFFICIENT OF FRICTION | DCOF ≥ 0,42

	modular system					Mosaico Mosaic	Battiscopa Skirting	Gradino costa retta Straight-edge step **			Gradino costa retta - Angolo SX / DX Straight-edge step - L/RH corner **				
															
	80x180 31 1/2"x71" Nat. Ret.	80x80 31 1/2"x31 1/2" Nat. Ret.	60x120* 24"x48" Nat. Ret.	60x60 24"x24" Nat. Ret.	30x60 12"x24" Nat. Ret.	30x30 12"x12" Nat. Ret.	6,5x120 2 1/2"x48" Nat. Ret.	7x60 3"x24" Nat. Ret.	33x120x3,2h 13"x48"x1 1/4" Nat. Ret.	33x80x3,2h 13"x31 1/2"x1 1/4" Nat. Ret.	33x60x3,2h 13"x24"x1 1/4" Nat. Ret.	33x120x3,2h 13"x48"x1 1/4" Nat. Ret.	33x80x3,2h 13"x31 1/2"x1 1/4" Nat. Ret.	33x60x3,2h 13"x24"x1 1/4" Nat. Ret.	
DARK 	I17004	I17021	I17013	I17046	I17071	I17093	I17098	I17104	I17210	I17222	I17234	I17212 SX I17211 DX	I17224 SX I17223 DX	I17236 SX I17235 DX	
FOG 	I17003	I17020	I17012	I17045	I17070	I17092	I17097	I17103	I17207	I17219	I17231	I17209 SX I17208 DX	I17221 SX I17220 DX	I17233 SX I17232 DX	
SALT 	I17001	I17018	I17010	I17043	I17068	I17090	I17095	I17101	I17201	I17213	I17225	I17203 SX I17202 DX	I17215 SX I17214 DX	I17227 SX I17226 DX	
SAND 	I17002	I17019	I17011	I17044	I17069	I17091	I17096	I17102	I17204	I17216	I17228	I17206 SX I17205 DX	I17218 SX I17217 DX	I17230 SX I17229 DX	
PREZZO PRICE	€ 58,00 m <sup>2</sup>	€ 36,00 m <sup>2</sup>	€ 40,00 m <sup>2</sup>	€ 33,00 m <sup>2</sup>	€ 32,00 m <sup>2</sup>	€ 68,00 m <sup>2</sup>	€ 8,00 PZ/PCE	€ 5,00 PZ/PCE	€ 140,00 PZ/PCE	€ 100,00 PZ/PCE	€ 68,00 PZ/PCE	€ 152,00 PZ/PCE	€ 112,00 PZ/PCE	€ 84,00 PZ/PCE	
CODICE PREZZO PRICE CODE	M125	M089	M097	M083	M081	M135	P029	P017	P207	P167	P135	P219	P179	P151	
	Pallet con sponde 97x188	Epal 80x120	Epal 80x120	Epal 80x120	Epal 80x120	Epal 80x120	Epal 80x120	Epal 80x120	Epal 80x120	Epal 80x120	Epal 80x120	Epal 80x120	Epal 80x120	Epal 80x120	Epal 80x120
IMBALLO cm h. PACKING cm h.	95	95	75	75	75	-	-	-	-	-	-	-	-	-	-
 x 	2	2	2	3	6	6	6	15	2	2	4	1	1	2	
m <sup>2</sup> x 	2,88	1,28	1,44	1,08	1,08	0,54	-	-	-	-	-	-	-	-	
Kg x 	71,28	30,14	33,12	25,30	25,06	12,15	11,00	14,76	23,00	16,00	23,00	12,00	8,50	12,00	
 x 	20	40	32	40	40	-	-	-	-	-	-	-	-	-	
m <sup>2</sup> x 	57,60	51,20	46,08	43,20	43,20	-	-	-	-	-	-	-	-	-	
Kg x 	1.456	1.226	1.080	1.032	1.022	-	-	-	-	-	-	-	-	-	

\* NUOVA PALLETIZZAZIONE DISPONIBILE (AD ESAURIMENTO DELLO STOCK ESISTENTE).  
New pallet configuration (once current stock fully exhausted). -  
Nouvelle palettisation disponible (jusqu'à épuisement du stock existant).  
Neue Palettierung verfügbar (solange der Vorrat reicht). - Nueva paletización disponible (al agotarse las actuales existencias).  
Новые поддоны будут доступны (после расходования существующих запасов).















\*\* A DISPOSIZIONE SOLO SU RICHIESTA. TEMPI DI CONSEGNA: 30GG.  
Available upon request only. Delivery terms: 30 days.  
Disponible seulement sur requête. Délais de livraison: 30 jours.  
Verfügbar auf Anfrage. Lieferzeit: 30 Tage.  
Disponibile sólo bajo pedido. Plazo de entrega: 30 días.  
Изготавливается только по специальной заявке. Срок поставки: 30 дней.

PER IL GRADINO NON SI GARANTISCE LA STESSA TONALITÀ DEL FONDO.  
We cannot guarantee that the shade of the stair tile will be the same as the background tile.  
Pour la marche, nous ne garantissons pas la même tonalité du fond.  
Für die Stufe wird nicht der gleiche Farbton der Grundfliese garantiert.  
Para el peldaño no se garantiza el mismo tono del fondo.  
Для ступени не гарантирована одинаковость тона с фоном.

# STORM

10 mm RII-C

ANSI A - 137.1: 2012  
WET DYNAMIC COEFFICIENT OF FRICTION | DCOF ≥ 0,42

		<b>30,5x60,5</b> 12"x24" Nat.
DARK		I17063
FOG		I17062
SALT		I17060
SAND		I17061
PREZZO PRICE		€ 24,00 m <sup>2</sup>
CODICE PREZZO PRICE CODE		M065
		<b>Epat</b> 80x120
IMBALLO cm h. PACKING cm h.		75
	 x 	8
	m <sup>2</sup> x 	1,48
	Kg x 	33,65
	 x 	32
	m <sup>2</sup> x 	47,36
	Kg x 	1.097



Floor  
Salt 80x80 (31 1/2"x31 1/2") 20 mm Nat. Ret. RII



# STORM

20 mm RII-C

ANSI A - I37.1: 2012  
WET DYNAMIC COEFFICIENT OF FRICTION | COF ≥ 0,42

	Gradone bordo svasato Large step with rounded border				Gradone bordo svasato - Angolo SX / DX Large step with rounded border - Corner SX / DX				Canalina Channel	Canalina - Angolo SX / DX Channel - Corner SX / DX		Cordolo U-Border		Cordolo - Angolo SX / DX U-Border - Corner SX / DX		
	40x80 16"x31 1/2"		30x60 12"x24"		40x80 16"x31 1/2"		30x60 12"x24"		20x80x8h 8"x31 1/2"x3"h	15x60x8h 6"x24"x3"h	20x80x8h 8"x31 1/2"x3"h	15x60x8h 6"x24"x3"h	15x60x15h 6"x24"x6"h	13x80x13h 5"x31 1/2"x5"h	15x60x15h 6"x24"x6"h	13x80x13h 5"x31 1/2"x5"h
	C	E	C	E	C	E	C	E								
DARK	117395	117383	117554	117542	117403 SX 117399 DX	117391 SX 117387 DX	117562S SX 117558 DX	117550 SX 117683 DX	117347	117482	117355 SX 117351 DX	117490 SX 117486 DX	117458	117335	117466 SX 117462 DX	117343 SX 117339 DX
FOG	117394	117382	117553	117541	117402 SX 117398 DX	117390 SX 117386 DX	117561 SX 117557 DX	117549 SX 117682 DX	117346	117481	117354 SX 117350 DX	117489 SX 117485 DX	117457	117334	117465 SX 117461 DX	117342 SX 117338 DX
SALT	117392	117380	117551	117539	117401 SX 117396 DX	117388 SX 117384 DX	117559 SX 117555 DX	117547 SX 117680 DX	117344	117479	117352 SX 117348 DX	117487 SX 117483 DX	117455	117332	117463 SX 117459 DX	117340 SX 117336 DX
SAND	117393	117381	117552	117540	117400 SX 117397 DX	117389 SX 117385 DX	117560 SX 117556 DX	117548 SX 117681 DX	117345	117480	117353 SX 117349 DX	117488 SX 117484 DX	117456	117333	117464 SX 117460 DX	117341 SX 117337 DX
PREZZO PRICE	€ 190,00 PZ/PCE	€ 168,00 PZ/PCE	€ 130,00 PZ/PCE	€ 114,00 PZ/PCE	€ 208,00 PZ/PCE	€ 186,00 PZ/PCE	€ 152,00 PZ/PCE	€ 138,00 PZ/PCE	€ 122,00 PZ/PCE	€ 90,00 PZ/PCE	€ 150,00 PZ/PCE	€ 108,00 PZ/PCE	€ 110,00 PZ/PCE	€ 162,00 PZ/PCE	€ 134,00 PZ/PCE	€ 190,00 PZ/PCE
CODICE PREZZO PRICE CODE	P257	P235	P197	P181	P271	P253	P219	P205	P189	P157	P217	P175	P177	P229	P201	P257
	Epal 80x120		Epal 80x120		Epal 80x120		Epal 80x120		Epal 80x120	Epal 80x120	Epal 80x120	Epal 80x120	Epal 80x120	Epal 80x120	Epal 80x120	Epal 80x120
IMBALLO cm h. PACKING cm h.	-		-		-		-		-	-	-	-	-	-	-	-
x	1		1		1		1		1	1	1	1	1	1	1	1
m <sup>2</sup> x	-		-		-		-		-	-	-	-	-	-	-	-
Kg x	12,50		9,00		12,50		6,60		12,00	8,00	13,00	7,00	13,50	12,00	11,80	13,00
x	-		-		-		-		-	-	-	-	-	-	-	-
m <sup>2</sup> x	-		-		-		-		-	-	-	-	-	-	-	-
Kg x	-		-		-		-		-	-	-	-	-	-	-	-

IL PESO DEI PEZZI SPECIALI 20 MM INDICATO IN TABELLA SI RIFERISCE AL PESO DEL SINGOLO PEZZO. PER CALCOLARE IL PESO COMPLESSIVO DEL MATERIALE IMBALLATO OCCORRERÀ AGGIUNGERE AL PESO IN TABELLA IL PESO DELL'IMBALLO E DELLA PALETTA (PESO VARIABILE DA 10 A 30 KG IN FUNZIONE DELLA QUANTITÀ E DELLA TIPOLOGIA DEI PEZZI SPECIALI RICHIESTI).

The weight of the 20 mm TRIMS stated in the table refers to the weight of each trim. - To calculate the total weight of the packed material, you will need to add the combined weight of the packing materials and the pallet (weight ranging from 10 to 30kg depending on the quantity and the type of the trims required) to the weight stated in the table.

Le poids des PIÈCES SPECIALES 20 mm indiqué dans le tableau se réfère au poids individuel de chaque pièce. Pour calculer le poids total du matériel emballé, il faudra ajouter au poids indiqué dans le tableau le poids de l'emballage et de la palette (poids variable de 10 à 30 kg en fonction de la quantité et du type de PIÈCES SPECIALES demandées).

Das in der Tabelle angegebene Gewicht der 20 mm-SONDERTEILE bezieht sich auf das Gewicht des Einzelteils. Zur Berechnung des Gesamtgewichts des verpackten Materials muss zum in der Tabelle aufgeführten Wert das Gewicht der Verpackung und der Palette (von 10 bis 30 kg variierbar in Abhängigkeit von der Menge und Art der gewünschten SONDERTEILE) dazugerechnet werden.

El peso de las PIEZAS ESPECIALES 20 mm indicado en la tabla se refiere al peso de cada pieza singularmente considerada. Para calcular el peso total del material embalado se deberá agregar al peso según la tabla, el peso del embalaje y del palet (peso variable entre 10 y 30 kg en función de la cantidad y tipo de las PIEZAS ESPECIALES requeridas).

Указанный в таблице вес СПЕЦИАЛЬНЫХ ИЗДЕЛИЙ 20 мм - это вес каждого отдельного изделия. Для расчета общего веса упакованного материала необходимо добавить к указанному в таблице значению вес упаковки и поддона (вес может составлять от 10 до 30 кг, в зависимости от количества и типа заказанных СПЕЦИАЛЬНЫХ ИЗДЕЛИЙ).



**Costa toro.**  
Bullnose edge.  
Bord boudin.  
Abgerundete Kante.  
Canto redondo.  
Закругленная кромка.



**Costa retta.**  
Straight edge.  
Bord droit.  
Gerade Kante.  
Canto recto.  
Прямоугольная кромка.

**ATTENZIONE:** Per particolari installazioni potrebbero essere necessari articoli ed accessori specifici non presenti in questo catalogo. Per queste esigenze prego riferirsi direttamente al referente commerciale La Fabbrica.

N.B. Particular items and accessories not listed in this catalogue may be required for certain laying methods. For these needs, please contact the La Fabbrica sales sales directly.

ATTENTION : Pour les installations particulières, certains articles et accessoires particuliers qui ne sont pas indiqués dans ce catalogue pourraient être nécessaires. Dans ces cas-là, nous vous prions de vous référer directement à la référence commerciale La Fabbrica.

ACHTUNG: Für besondere Installationen können besondere Artikel oder Sonderzubehör notwendig sein, die nicht im vorliegenden Katalog aufgeführt sind. Wenden Sie sich bitte in diesen Fällen direkt an den Vertrieb von La Fabbrica.

ATENCIÓN: para instalaciones particulares podrían requerirse artículos y accesorios específicos que no están presentes en este catálogo. Para tales casos rogamos contactar directamente al representante comercial de La Fabbrica.

ВНИМАНИЕ: Для особых применений могут быть необходимы специальные артикулы и аксессуары, не представленные в данном каталоге. По поводу этих вопросов просим вас обращаться непосредственно к менеджеру коммерческого отдела компании La Fabbrica.



Civilization of Beauty

# MATERICO

Textured . Matièreque . Materisch . Matérico . Фактурная поверхность .

## INDOOR

AGGLOMERATE.....	256
ARTILE.....	268
BRUSH.....	280
COTTO DEL CASALE.....	288
FUSION.....	300
LASCAUX.....	308
RA-KU.....	318
RESINE.....	328
SPACE.....	336
STEELISTIC.....	350

## OUTDOOR RII-C

COTTO DEL CASALE.....	288
SPACE.....	336

## OUTDOOR 20 mm . RII-C

AGGLOMERATE.....	256
SPACE.....	336





Wall: Agate 120x120 (48"x48") Nat. Ret. - Decoro Fascia Tahiti 30x120 (12"x48") Lap. - Bacchetta di Metallo Ferro Goccia 0.8x120 (11"x48") / Floor: Tahiti 120x120 (48"x48") Nat. Ret. - Mosaico Freccia Agate 30x35 (12"x13 3/4") Nat. Lap.

# AGGLOMERATE

GRES PORCELLANATO COLORATO IN MASSA . COLORED BODY PORCELAIN STONEWARE  
GRÈS CÉRAME COLORÉ DANS LA MASSE . EINGEFÄRBTES FEINSTEINZEUG  
GRES PORCELÁNICO COLOREADO EN MASA . КЕРАМОГРАНИТ ОКРАШЕННЫЙ В МАССЕ  
ISO 13006 - G - B1a (E ≤ 0,5%) - UNI EN 14411 - G

100% DESIGN  
AND PRODUCTION  
OF ITALY

V2  
SHADE SPECTRUM  
MODERATE

## INDOOR

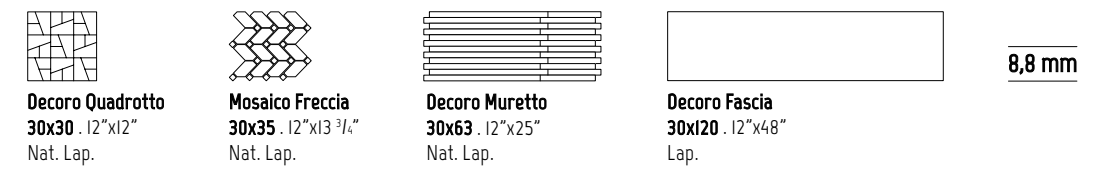
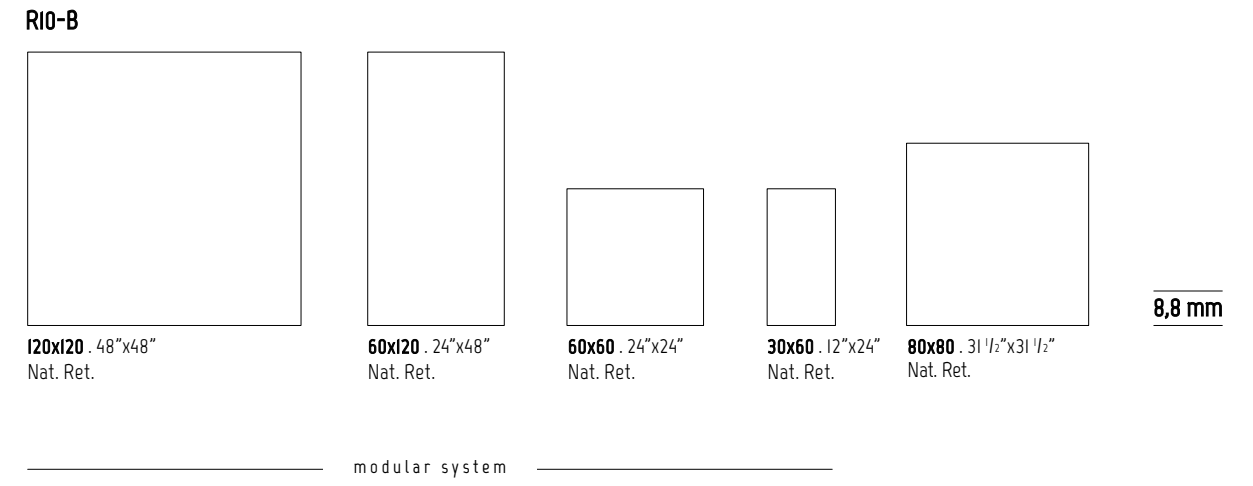

## OUTDOOR

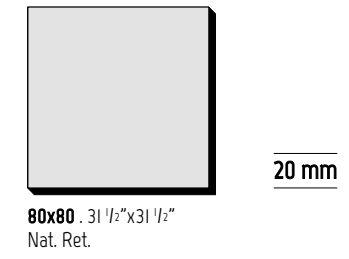

SVILUPPO GRAFICO PER FORMATO Pattern by size Développement graphique par format Grafischer Entwurf für Format Desarrollo gráfico por formato Варианты графики для каждого формата	120x120 8,8 mm	60x120 8,8 mm	80x80 8,8 mm	60x60 8,8 mm	30x60 8,8 mm	80x80 20 mm
	8	12	15	24	47	15

# AGGLOMERATE

8,8 mm R10-B



Wall  
Decoro Muretto Pearl 30x63 (12"x25") Nat. Lap.

Floor  
Pearl 60x120 (24"x48") Nat. Ret.  
Decoro Fascia Pearl 30x120 (12"x48") Lap.

Wall  
Pearl 30x60 (12"x24") Nat. Ret.  
Decoro Fascia Agate 30x120 (12"x48") Lap.  
Decoro Fascia Pearl 30x120 (12"x48") Lap.  
Bacchetta di Metallo Ferro Goccia 0,8x120 (1/2"x48")  
Decoro Muretto Agate 30x63 (12"x25") Nat. Lap.

Floor  
Agate 60x120 (24"x48") Nat. Ret.  
120x120 (48"x48") Nat. Ret.

# AGGLOMERATE

## TAHITI

INDOOR

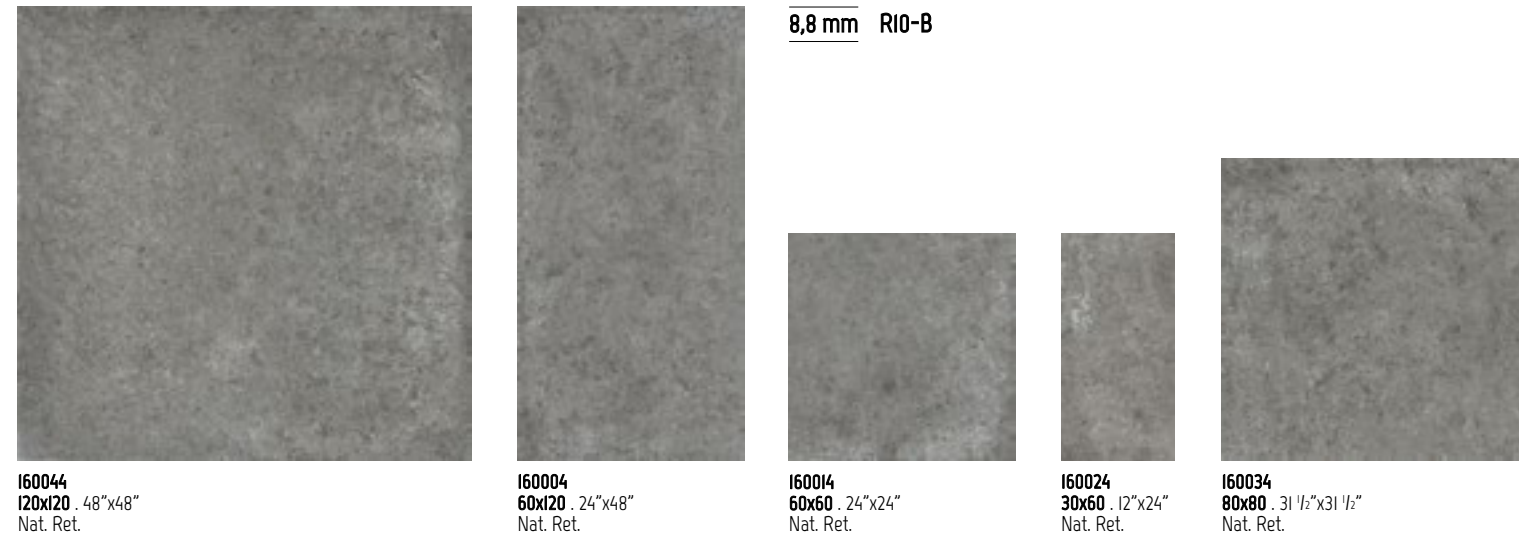

8,8 mm R10-B

**160044**  
120x120 . 48"x48"  
Nat. Ret.

**160004**  
60x120 . 24"x48"  
Nat. Ret.

**160014**  
60x60 . 24"x24"  
Nat. Ret.

**160024**  
30x60 . 12"x24"  
Nat. Ret.

**160034**  
80x80 . 31 1/2"x31 1/2"  
Nat. Ret.

modular system



**160064**  
Decoro Fascia Tahiti  
30x120 . 12"x48"  
Lap.

**160304**  
Mosaico Freccia  
30x35 . 12"x13 3/4"  
Nat. Lap.

**160314**  
Decoro Quadrotto  
30x30 . 12"x12"  
Nat. Lap.

**160324**  
Decoro Muretto  
30x63 . 12"x25"  
Nat. Lap.

**160601**  
Bacchetta di Metallo Ferro Goccia  
0,8x120 . 1/2"x48"

**160602**  
Bacchetta di metallo Corten  
0,8x120 . 1/2"x48"

**160603**  
Bacchetta di metallo Ferro battuto  
0,8x120 . 1/2"x48"

## OUTDOOR



20 mm R11-C

**160054**  
80x80 . 31 1/2"x31 1/2"  
Nat. Ret.

## AGATE

INDOOR



8,8 mm R10-B

**160043**  
120x120 . 48"x48"  
Nat. Ret.

**160003**  
60x120 . 24"x48"  
Nat. Ret.

**160013**  
60x60 . 24"x24"  
Nat. Ret.

**160023**  
30x60 . 12"x24"  
Nat. Ret.

**160033**  
80x80 . 31 1/2"x31 1/2"  
Nat. Ret.

modular system

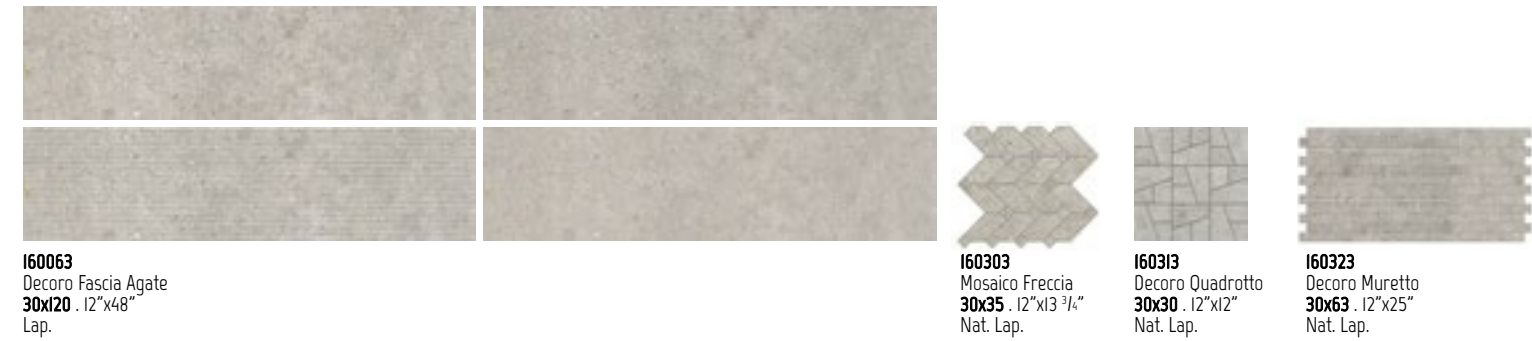

**160063**  
Decoro Fascia Agate  
30x120 . 12"x48"  
Lap.

**160303**  
Mosaico Freccia  
30x35 . 12"x13 3/4"  
Nat. Lap.

**160313**  
Decoro Quadrotto  
30x30 . 12"x12"  
Nat. Lap.

**160323**  
Decoro Muretto  
30x63 . 12"x25"  
Nat. Lap.

**160601**  
Bacchetta di Metallo Ferro Goccia  
0,8x120 . 1/2"x48"

**160602**  
Bacchetta di metallo Corten  
0,8x120 . 1/2"x48"

**160603**  
Bacchetta di metallo Ferro battuto  
0,8x120 . 1/2"x48"

## OUTDOOR

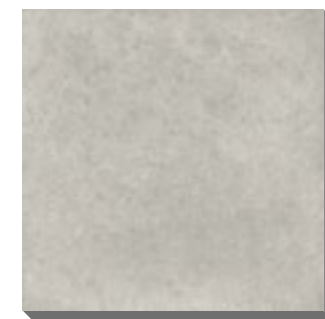

20 mm R11-C

**160053**  
80x80 . 31 1/2"x31 1/2"  
Nat. Ret.

# AGGLOMERATE

## PEARL

INDOOR

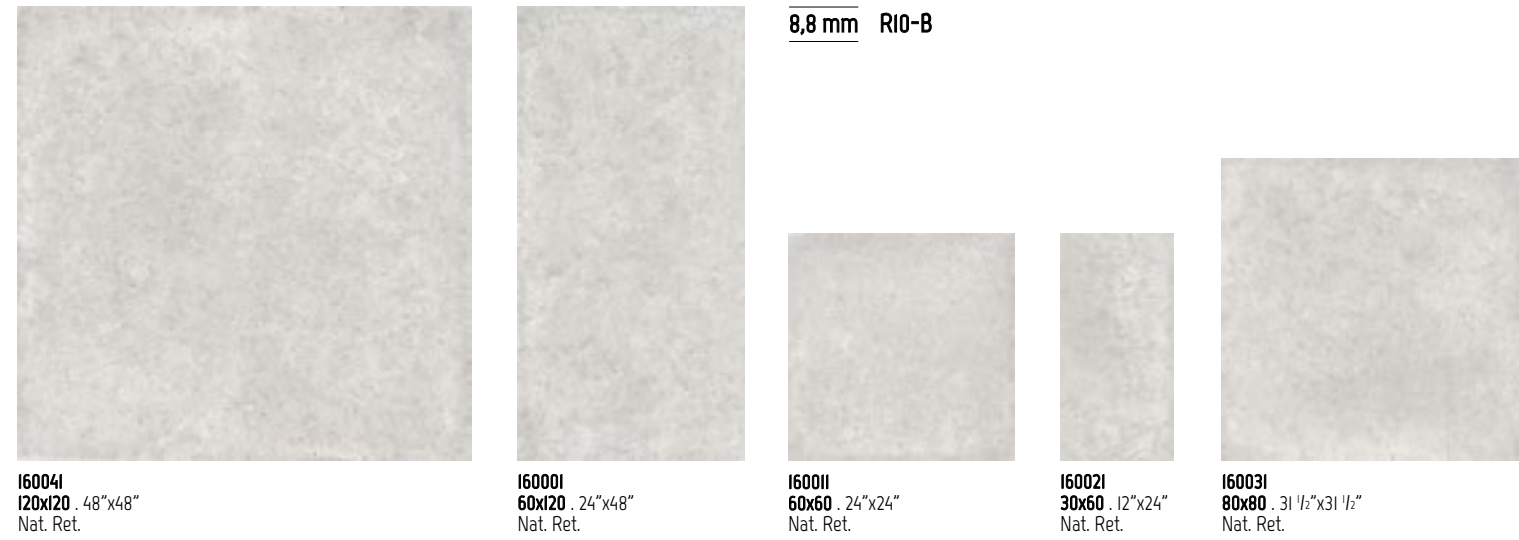

8,8 mm R10-B

**160041**  
120x120 . 48"x48"  
Nat. Ret.

**160001**  
60x120 . 24"x48"  
Nat. Ret.

**160011**  
60x60 . 24"x24"  
Nat. Ret.

**160021**  
30x60 . 12"x24"  
Nat. Ret.

**160031**  
80x80 . 31 1/2"x31 1/2"  
Nat. Ret.

modular system

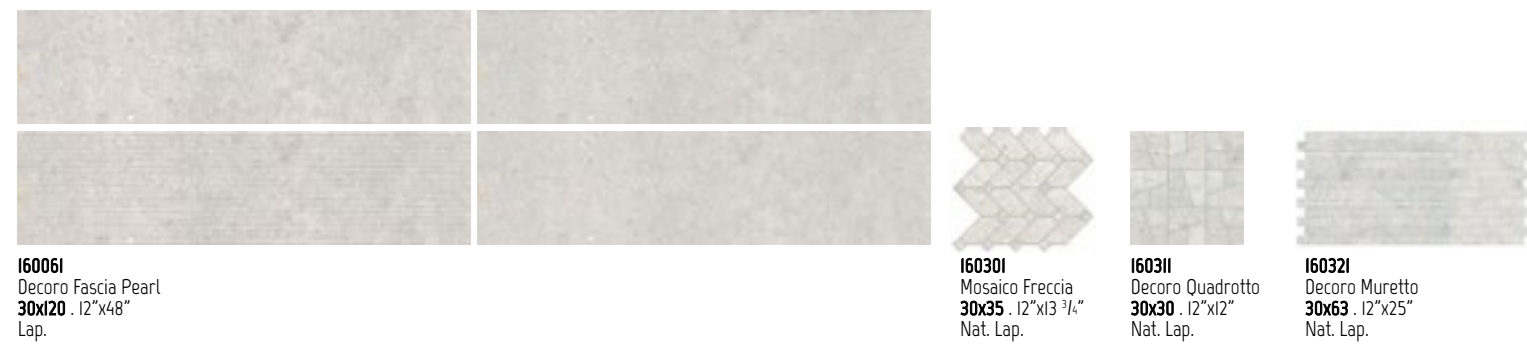

**160061**  
Decoro Fascia Pearl  
30x120 . 12"x48"  
Lap.

**160301**  
Mosaico Freccia  
30x35 . 12"x13 3/4"  
Nat. Lap.

**160311**  
Decoro Quadrotto  
30x30 . 12"x12"  
Nat. Lap.

**160321**  
Decoro Muretto  
30x63 . 12"x25"  
Nat. Lap.

**160601**  
Bacchetta di Metallo Ferro Goccia  
0,8x120 . 1/5"x48"

**160602**  
Bacchetta di metallo Corten  
0,8x120 . 1/5"x48"

**160603**  
Bacchetta di metallo Ferro battuto  
0,8x120 . 1/5"x48"

## OUTDOOR



20 mm R11-C

**160051**  
80x80 . 31 1/2"x31 1/2"  
Nat. Ret.

## SHELL

INDOOR

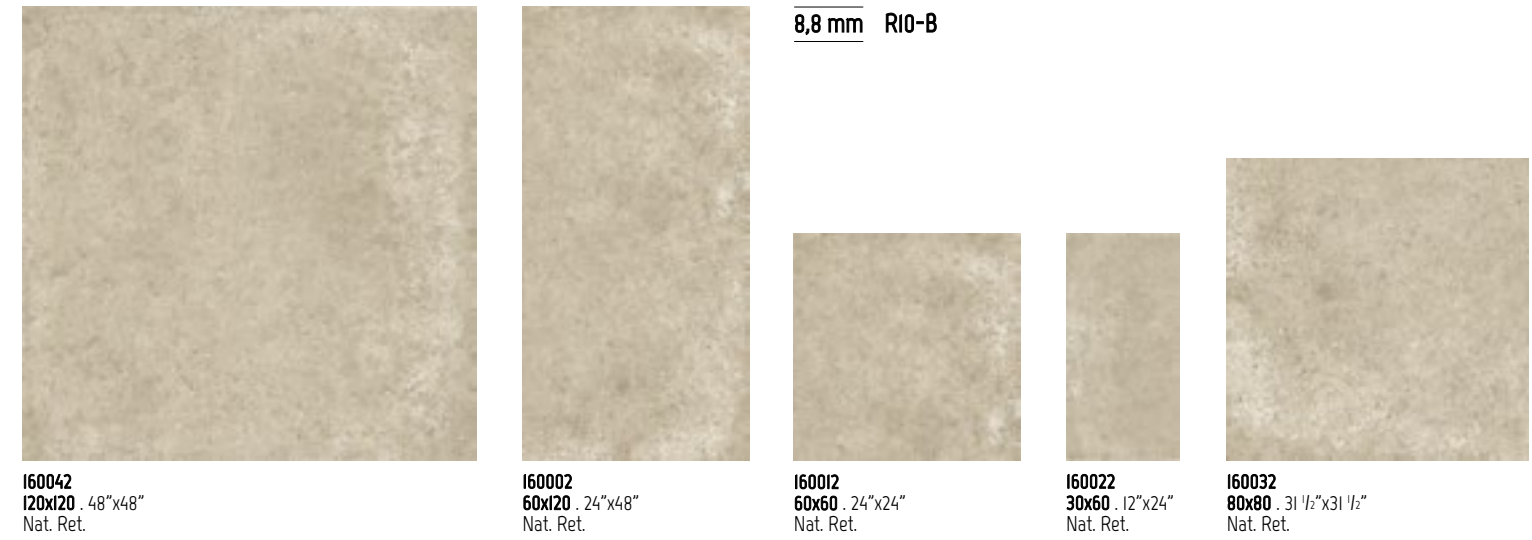

8,8 mm R10-B

**160042**  
120x120 . 48"x48"  
Nat. Ret.

**160002**  
60x120 . 24"x48"  
Nat. Ret.

**160012**  
60x60 . 24"x24"  
Nat. Ret.

**160022**  
30x60 . 12"x24"  
Nat. Ret.

**160032**  
80x80 . 31 1/2"x31 1/2"  
Nat. Ret.

modular system



**160062**  
Decoro Fascia Shell  
30x120 . 12"x48"  
Lap.

**160302**  
Mosaico Freccia  
30x35 . 12"x13 3/4"  
Nat. Lap.

**160312**  
Decoro Quadrotto  
30x30 . 12"x12"  
Nat. Lap.

**160322**  
Decoro Muretto  
30x63 . 12"x25"  
Nat. Lap.

**160601**  
Bacchetta di Metallo Ferro Goccia  
0,8x120 . 1/5"x48"

**160602**  
Bacchetta di metallo Corten  
0,8x120 . 1/5"x48"

**160603**  
Bacchetta di metallo Ferro battuto  
0,8x120 . 1/5"x48"

## OUTDOOR



20 mm R11-C









**160052**  
80x80 . 31 1/2"x31 1/2"  
Nat. Ret.

# AGGLOMERATE

8,8 mm RIO-B

Solo superficie naturale  
Only natural surface

ANSI A - 137.1: 2012  
WET DYNAMIC COEFFICIENT OF FRICTION | DCOF ≥ 0,42

	modular system					Decoro Fascia Band decorative tile *	Mosaico Freccia Freccia mosaic	Decoro Quadrotto Quadrotto decorative tile	Decoro Muretto Brick-effect mosaic decorative tile	Bacchetta di Metallo Ferro goccia Drop iron rod	Bacchetta di metallo Corten Corten steel rod	Bacchetta di Metallo Ferro battuto Wrought iron rod	Battiscopa Skirting	Gradino costa retta Straight-edge step **	Gradino costa retta - Angolo SX / DX Straight-edge step - LH/RH corner **	
	120x120 48"x48" Nat. Ret.	60x120 24"x48" Nat. Ret.	60x60 24"x24" Nat. Ret.	30x60 12"x24" Nat. Ret.	80x80 31 1/2"x31 1/2" Nat. Ret.	30x120 12"x48" Lap.	30x35 12"x13 3/4" Nat. Lap.	30x30 12"x12" Nat. Lap.	30x63 12"x25 " Nat. Lap.	0,8x120 1/3"x48"	0,8x120 1/3"x48"	0,8x120 1/3"x48"	8x80 3"x31 1/2" Nat. Ret.	7x60 3"x24" Nat. Ret.	33x120x3,2h 13"x48"x1 1/4"h Nat. Ret.	33x120x3,2h 13"x48"x1 1/4"h Nat. Ret.
TAHITI	160044	160004	160014	160024	160034	160064	160304	160314	160324	160601	160602	160603	160104	160114	160204	160224 SX 160214 DX
AGATE	160043	160003	160013	160023	160033	160063	160303	160313	160323				160103	160113	160203	160223 SX 160213 DX
PEARL	160041	160001	160011	160021	160031	160061	160301	160311	160321				160101	160111	160201	160221 SX 160211 DX
SHELL	160042	160002	160012	160022	160032	160062	160302	160312	160322				160102	160112	160202	160222 SX 160212 DX
PREZZO PRICE	€ 54,00 m²	€ 40,00 m²	€ 33,00 m²	€ 32,00 m²	€ 36,00 m²	€ 58,00 m²	€ 150,00 m²	€ 198,00 m²	€ 184,00 m²	€ 26,00 PZ/PCE	€ 31,00 PZ/PCE	€ 26,00 PZ/PCE	€ 7,00 PZ/PCE	€ 5,00 PZ/PCE	€ 140,00 PZ/PCE	€ 172,00 PZ/PCE
CODICE PREZZO PRICE CODE	M121	M097	M083	M081	M089	M125	M217	M265	M251	P069	P079	P069	P025	P017	P207	P239
	Pallet 143x123x55 h	Epal 80x120	Epal 80x120	Epal 80x120	Epal 80x120	Pallet 107x123x43 h	Epal 80x120	Epal 80x120	Epal 80x120	Epal 80x120	Epal 80x120	Epal 80x120	Epal 80x120	Epal 80x120	Epal 80x120	Epal 80x120
IMBALLO cm h. PACKING cm h.	70	75	75	75	95	43	-	-	60	-	-	-	-	-	-	-
 x 	2	2	3	6	2	4	6	6	5	6	6	6	11	15	2	1
m² x 	2,88	1,44	1,08	1,08	1,28	1,44	0,63	0,54	0,9	-	-	-	0,7	0,63	-	-
Kg x 	57,06	29,82	22,84	22,64	25,92	29,52	12,90	10,75	18,00	4,00	4,00	4,00	14,80	13,28	20,70	10,80
 x 	16	32	40	40	40	21	-	-	30	-	-	-	-	-	-	-
m² x 	46,08	46,08	43,20	43,20	51,20	30,24	-	-	27	-	-	-	-	-	-	-
Kg x 	958	974	934	926	1.057	640	-	-	540	-	-	-	-	-	-	-

\*\* A DISPOSIZIONE SOLO SU RICHIESTA. TEMPI DI CONSEGNA: 30GG.

Available upon request only. Delivery terms: 30 days.  
Disponible seulement sur requête. Délais de livraison: 30 jours.  
Verfügbar auf Anfrage. Lieferzeit: 30 Tage.  
Disponibile sólo bajo pedido. Plazo de entrega: 30 días.  
Изготавливается только по специальной заявке. Срок поставки: 30 дней.

PER IL GRADINO NON SI GARANTISCE LA STESSA TONALITÀ DEL FONDO.

We cannot guarantee that the shade of the stair tile will be the same as the background tile.  
Pour la marche, nous ne garantissons pas la même tonalité du fond.  
Für die Stufe wird nicht der gleiche Farbton der Grundfliese garantiert.  
Para el peldaño no se garantiza el mismo tono del fondo.  
Для ступени не гарантирована одинаковость тона с фоном.

ATTENZIONE: Per un risultato ottimale si consiglia di utilizzare durante la posa i cunei.

ATTENTION: For a perfect result, we recommend you use wedges during laying.  
ATTENTION: Nous conseillons d'utiliser les coins durant la pose pour un résultat optimal.  
WARNUNG: Für ein ausgezeichnetes Ergebnis wird empfohlen, bei der Verlegung die Keile zu verwenden.  
ATENCIÓN: Para obtener un resultado optimizado se aconseja utilizar las cuñas durante la colocación.  
ВНИМАНИЕ: Для получения оптимального результата рекомендуется использовать клинья во время укладки.

\* IN OGNI SCATOLA LA COMBINAZIONE DEI SOGGETTI È DEL TUTTO CASUALE. LO STESSO SOGGETTO POTREBBE ESSERE RIPETUTO OPPURE POTREBBE NON ESSERE PRESENTE NELLA SCATOLA.

Each box contains a random assortment of the designs available. The same design may be repeated and certain designs may not be included in the box.  
La combinaison des motifs à l'intérieur de chaque boîte est absolument fortuite. Le même motif pourrait être répété ou ne pas se trouver à l'intérieur de la boîte.  
Die Zusammenstellung der Motive ist in jedem Karton vollkommen zufällig. Das selbe Motiv könnte sich wiederholen oder nicht im Karton vorhanden sein.  
En cada caja la combinación de los temas es del todo casual. En una caja un tema puede estar repetido o estar ausente.  
Сочетание мотивов в каждой коробке является совершенно случайным. Один и тот же мотив может присутствовать в коробке несколько раз или, наоборот, отсутствовать.

ATTENZIONE: Si consiglia di mantenere una fuga di 3 mm per la posa in multiformato degli articoli rettificati.

ATTENTION: In the case of straightened-edge tiles, we recommend you keep a 3 mm joint when laying different-sized tiles together.  
ATTENTION: Il est recommandé de maintenir un joint de 3 mm pour la pose en multiformat des articles rectifiés.  
WARNUNG: Es wird geraten, eine Fuge von 3 mm bei der Verlegung der geschliffenen Artikel als Multiformat einzuhalten.  
ATENCIÓN: Se aconseja mantener una junta de 3 mm para la colocación en multiformato de los artículos rectificados.  
ВНИМАНИЕ: Рекомендуем оставлять шов 3 мм при укладке обрезной продукции нескольких форматов.

# AGGLOMERATE

20 mm RII-C

Solo superficie naturale  
Only natural surface

ANSI A - 137.1: 2012  
WET DYNAMIC COEFFICIENT OF FRICTION

DCOF ≥ 0,42

		<b>80x80</b> 31 1/2" x 31 1/2" Nat. Ret.		<b>40x80</b> 16" x 31 1/2" Nat. Ret. C
TAHITI		I60054	I60404	
AGATE		I60053	I60403	
PEARL		I60051	I60401	
SHELL		I60052	I60402	
PREZZO PRICE	€ 70,00 m <sup>2</sup>	€ 112,00 PZ/PCE		
CODICE PREZZO PRICE CODE	M137	P179		
	<b>Epal</b> 80x120	<b>Epal</b> 80x120		
IMBALLO cm h. PACKING cm h.	95	-		
 x 	1	1		
m <sup>2</sup> x 	0,64	-		
Kg x 	27,78	12,50		
 x 	45	-		
m <sup>2</sup> x 	28,88	-		
Kg x 	1.270	-		



## TRA I FONDI DI SPESSORE 8,8 E 20 MM NON SI GARANTISCE L'ABBINABILITÀ.

We cannot guarantee tonal matches between the same background tiles with different thickness (8,8 or 20 mm).  
Les assortiments des tons ne sont pas garantis pour les fonds d'une épaisseur de 8,8 et 20 mm.  
Bei Bodenfliesen mit einer Stärke von 8,8 und 20 mm wird keine Einheitlichkeit der Farbtöne garantiert.  
Para los fondos de espesor 8,8 y 20 mm no se garantiza la combinabilidad de tonalidades.  
Для фоновой плитки толщиной 8,8 и 20 мм не гарантирована цветовая сочетаемость.

## IL PESO DEI PEZZI SPECIALI 20 MM INDICATO IN TABELLA SI RIFERISCE AL PESO DEL SINGOLO PEZZO. PER CALCOLARE IL PESO COMPLESSIVO DEL MATERIALE IMBALLATO OCCORRERÀ AGGIUNGERE AL PESO IN TABELLA IL PESO DELL'IMBALLO E DELLA PALETTA (PESO VARIABILE DA 10 A 30 KG IN FUNZIONE DELLA QUANTITÀ E DELLA TIPOLOGIA DEI PEZZI SPECIALI RICHIESTI).

The weight of the 20 mm TRIMS stated in the table refers to the weight of each trim. - To calculate the total weight of the packed material, you will need to add the combined weight of the packing materials and the pallet (weight ranging from 10 to 30kg depending on the quantity and the type of the trims required) to the weight stated in the table.  
Le poids des PIÈCES SPECIALES 20 mm indiqué dans le tableau se réfère au poids individuel de chaque pièce. Pour calculer le poids total du matériel emballé, il faudra ajouter au poids indiqué dans le tableau le poids de l'emballage et de la palette (poids variable de 10 à 30 kg en fonction de la quantité et du type de PIÈCES SPECIALES demandées).  
Das in der Tabelle angegebene Gewicht der 20 mm-SONDERTEILE bezieht sich auf das Gewicht des Einzelteils. Zur Berechnung des Gesamtgewichts des verpackten Materials muss zum in der Tabelle aufgeführten Wert das Gewicht der Verpackung und der Palette (von 10 bis 30 kg variierbar in Abhängigkeit von der Menge und Art der gewünschten SONDERTEILE) dazugerechnet werden.  
El peso de las PIEZAS ESPECIALES 20 mm indicado en la tabla se refiere al peso de cada pieza singularmente considerada. Para calcular el peso total del material embalado se deberá agregar al peso según la tabla, el peso del embalaje y del palet (peso variable entre 10 y 30 kg en función de la cantidad y tipo de las PIEZAS ESPECIALES requeridas).  
Указанный в таблице вес СПЕЦИАЛЬНЫХ ИЗДЕЛИЙ 20 мм - это вес каждого отдельного изделия. Для расчета общего веса упакованного материала необходимо добавить к указанному в таблице значению вес упаковки и поддона (вес может составлять от 10 до 30 кг, в зависимости от количества и типа заказанных СПЕЦИАЛЬНЫХ ИЗДЕЛИЙ).

INDOOR

Wall

Rivestimento cucina e cappa / Wall tiles for kitchens and cooker hood area  
Decoro Muretto Tahiti 30x63 (12"x25v") Nat. Lap.

Floor

Shell 80x80 (31 1/2"x31 1/2") Nat. Ret.

OUTDOOR

Floor

Shell 80x80 (31 1/2"x31 1/2") Nat. Ret. RII 20mm



Costa toro.

Bullnose edge.  
Bord boudin.  
Abgerundete Kante.  
Canto redondo.  
Закругленная кромка.

ATTENZIONE: Per particolari installazioni potrebbero essere necessari articoli ed accessori specifici non presenti in questo catalogo. Per queste esigenze prego riferirsi direttamente al referente commerciale La Fabbrica.

N.B. Particular items and accessories not listed in this catalogue may be required for certain laying methods. For these needs, please contact the La Fabbrica sales directly.

ATTENTION: Pour les installations particulières, certains articles et accessoires particuliers qui ne sont pas indiqués dans ce catalogue pourraient être nécessaires. Dans ces cas-là, nous vous prions de vous référer directement à la référence commerciale La Fabbrica.

ACHTUNG: Für besondere Installationen können besondere Artikel oder Sonderzubehör notwendig sein, die nicht im vorliegenden Katalog aufgeführt sind. Wenden Sie sich bitte in diesen Fällen direkt an den Vertrieb von La Fabbrica.

ATENCIÓN: para instalaciones particulares podrían requerirse artículos y accesorios específicos que no están presentes en este catálogo. Para tales casos rogamos contactar directamente al representante comercial de La Fabbrica.

ВНИМАНИЕ: Для особых применений могут быть необходимы специальные артикулы и аксессуары, не представленные в данном каталоге. По поводу этих вопросов просим вас обращаться непосредственно к менеджеру коммерческого отдела компании La Fabbrica.



Wall: Ivory 20x120 (8"x48") Nat. Ret. / Floor: Black Gold 60x120 (24"x48") Nat. Ret.

# ARTILE

GRES PORCELLANATO COLORATO IN MASSA . COLORED BODY PORCELAIN STONEWARE  
GRES CÉRAMÉ COLORÉ DANS LA MASSE . EINGEFÄRBTES FEINSTEINZEUG  
GRES PORCELÁNICO COLOREADO EN MASA . КЕРАМОГРАНИТ ОКРАШЕННЫЙ В МАССЕ  
ISO 13006 - G - B1a (E ≤ 0,5%) - UNI EN 14411 - G

100% DESIGN  
AND PRODUCTION  
OF ITALY

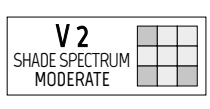

## INDOOR

RI0-B

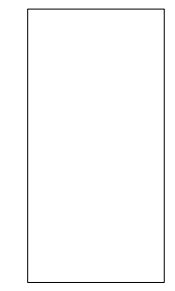

60x120 . 24"x48"  
Nat. Ret.

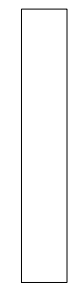

20x120 . 8"x48"  
Nat. Ret.

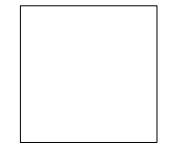

60x60 . 24"x24"  
Nat. Ret.

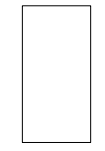

30x60 . 12"x24"  
Nat. Ret.

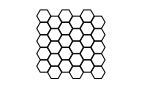

Esagona  
28x29 . 11"x11 1/2"  
Nat. Ret.



Spina di pesce  
27x25,5 . 10 1/2"x10"  
Nat. Ret.

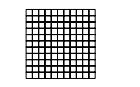

Mosaico  
30x30 . 12"x12"  
Nat. Ret.

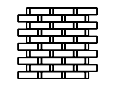

Muretto  
30x30 . 12"x12"  
Nat. Ret.

8,8 mm

modular system

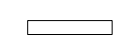

6,1x37 . 2 1/2"x14 1/2"  
Nat.

8 mm

SVILUPPO GRAFICO PER FORMATO  
Pattern by size  
Développement graphique par format  
Grafischer Entwurf für Format  
Desarrollo gráfico por formato  
Варианты графики для каждого формата

60x120	20x120	60x60	30x60	6,1x37
8,8 mm	8,8 mm	8,8 mm	8,8 mm	8 mm
18	12	36	18	54

# ARTILE

8,8 mm R10-B



Wall  
Ivory 30x60 (12"x24") Nat. Ret.  
Decoro Spina di pesce Ivory 27x25,5 (10 1/2"x10") Nat. Ret.  
Decoro Esagona Ivory 28x29 (11"x11 1/2") Nat. Ret.

Floor  
Ocean Blue 60x120 (24"x48") Nat. Ret.





Wall  
Ivory 60x120 (24"x48") Nat. Ret.

Floor  
Greige 60x120 (24"x48") Nat. Ret.

Wall  
Ivory 30x60 (12"x24") Nat. Ret.  
Decoro Mosaico Ivory 30x30 (12"x12") Nat. Ret.  
Decoro Muretto Ivory 30x30 (12"x12") Nat. Ret.

Floor  
Sage 20x120 (8"x48") Nat. Ret.

# ARTILE

## BLACK GOLD

INDOOR

**8,8 mm R10-B**

**I56006**  
60x120 . 24"x48"  
Nat. Ret.

**I56031**  
20x120 . 8"x48"  
Nat. Ret.

**I56011**  
60x60 . 24"x24"  
Nat. Ret.

**I56021**  
30x60 . 12"x24"  
Nat. Ret.

**I56331**  
Esagona  
28x29 . 11"x11 1/2"  
Nat. Ret.

**I56301**  
Spina di pesce  
27x25,5 . 10 1/2"x10"  
Nat. Ret.

**I56321**  
Mosaico  
30x30 . 12"x12"  
Nat. Ret.

**I56311**  
Muretto  
30x30 . 12"x12"  
Nat. Ret.

modular system

**8 mm R10-B**

**I56041**  
6,1x37 . 2 1/2"x14 1/2"  
Nat.

## SAGE

INDOOR

**8,8 mm R10-B**

**I56005**  
60x120 . 24"x48"  
Nat. Ret.

**I56035**  
20x120 . 8"x48"  
Nat. Ret.

**I56015**  
60x60 . 24"x24"  
Nat. Ret.

**I56025**  
30x60 . 12"x24"  
Nat. Ret.

**I56335**  
Esagona  
28x29 . 11"x11 1/2"  
Nat. Ret.

**I56305**  
Spina di pesce  
27x25,5 . 10 1/2"x10"  
Nat. Ret.

**I56325**  
Mosaico  
30x30 . 12"x12"  
Nat. Ret.

**I56315**  
Muretto  
30x30 . 12"x12"  
Nat. Ret.

modular system

**8 mm R10-B**

**I56045**  
6,1x37 . 2 1/2"x14 1/2"  
Nat.

## OCEAN BLUE

INDOOR

**8,8 mm R10-B**

**I56004**  
60x120 . 24"x48"  
Nat. Ret.

**I56036**  
20x120 . 8"x48"  
Nat. Ret.

**I56016**  
60x60 . 24"x24"  
Nat. Ret.

**I56026**  
30x60 . 12"x24"  
Nat. Ret.

**I56336**  
Esagona  
28x29 . 11"x11 1/2"  
Nat. Ret.

**I56306**  
Spina di pesce  
27x25,5 . 10 1/2"x10"  
Nat. Ret.

**I56326**  
Mosaico  
30x30 . 12"x12"  
Nat. Ret.

**I56316**  
Muretto  
30x30 . 12"x12"  
Nat. Ret.

modular system

**8 mm R10-B**

**I56046**  
6,1x37 . 2 1/2"x14 1/2"  
Nat.

## IVORY

INDOOR

**8,8 mm R10-B**

**I56001**  
60x120 . 24"x48"  
Nat. Ret.

**I56033**  
20x120 . 8"x48"  
Nat. Ret.

**I56013**  
60x60 . 24"x24"  
Nat. Ret.

**I56023**  
30x60 . 12"x24"  
Nat. Ret.

**I56333**  
Esagona  
28x29 . 11"x11 1/2"  
Nat. Ret.

**I56303**  
Spina di pesce  
27x25,5 . 10 1/2"x10"  
Nat. Ret.

**I56323**  
Mosaico  
30x30 . 12"x12"  
Nat. Ret.

**I56313**  
Muretto  
30x30 . 12"x12"  
Nat. Ret.

modular system

**8 mm R10-B**

**I56043**  
6,1x37 . 2 1/2"x14 1/2"  
Nat.

# ARTILE

## GREIGE

INDOOR



**I56002**  
60x120 . 24"x48"  
Nat. Ret.



**I56032**  
20x120 . 8"x48"  
Nat. Ret.

8,8 mm R10-B



**I56012**  
60x60 . 24"x24"  
Nat. Ret.



**I56022**  
30x60 . 12"x24"  
Nat. Ret.



**I56332**  
Esagona  
28x29 . 11"x11 1/2"  
Nat. Ret.



**I56302**  
Spina di pesce  
27x25,5 . 10 1/2"x10"  
Nat. Ret.



**I56322**  
Mosaico  
30x30 . 12"x12"  
Nat. Ret.



**I56312**  
Muretto  
30x30 . 12"x12"  
Nat. Ret.

modular system

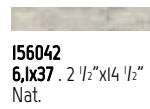

**I56042**  
6,1x37 . 2 1/2"x14 1/2"  
Nat.

8 mm R10-B

## COPPER

INDOOR



**I56003**  
60x120 . 24"x48"  
Nat. Ret.



**I56034**  
20x120 . 8"x48"  
Nat. Ret.

8,8 mm R10-B



**I56014**  
60x60 . 24"x24"  
Nat. Ret.



**I56024**  
30x60 . 12"x24"  
Nat. Ret.



**I56334**  
Esagona  
28x29 . 11"x11 1/2"  
Nat. Ret.



**I56304**  
Spina di pesce  
27x25,5 . 10 1/2"x10"  
Nat. Ret.

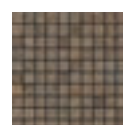

**I56324**  
Mosaico  
30x30 . 12"x12"  
Nat. Ret.



**I56314**  
Muretto  
30x30 . 12"x12"  
Nat. Ret.

modular system

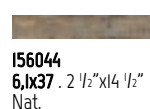

**I56044**  
6,1x37 . 2 1/2"x14 1/2"  
Nat.

8 mm R10-B











Wall  
Decoro Mosaico Copper 30x30 (12"x12") Nat. Ret.  
Copper 6,1x37 (2 1/2"x14 1/2") Nat.

Floor  
Greige 20x120 (8"x48") Nat. Ret.

# ARTILE

8,8 mm RIO-B

ANSI A - 137.1: 2012  
WET DYNAMIC COEFFICIENT OF FRICTION | DCOF ≥ 0,42

	modular system					Decoro Esagona Esagona decorative tile	Decoro Spina di pesce Spina di pesce decorative tile	Mosaico Mosaic	Muretto Brick-effect mosaic	Battiscopa Skirting	Gradino costa retta Straight-edge step **	Gradino costa retta - Angolo SX / DX Straight-edge step - LHRH corner **
	60x120 24"x48" Nat. Ret.	20x120 8"x48" Nat. Ret.	60x60 24"x24" Nat. Ret.	30x60 12"x24" Nat. Ret.	6,1x37 2 1/2"x14 1/2" Nat. 8 mm	28x29 11"x11 1/2" Nat. Ret.	30x30 12"x12" Nat. Ret.	30x30 12"x12" Nat. Ret.	7x60 3"x24" Nat. Ret.	33x120x3,2h 13"x48"x1 1/4"h Nat. Ret.	33x120x3,2h 13"x48"x1 1/4"h Nat. Ret.	
BLACK GOLD	I56006	I56031	I56011	I56021	I56041	I56331	I56301	I56321	I56311	I56101	I56201	I56221 SX I56211 DX
SAGE	I56005	I56035	I56015	I56025	I56045	I56335	I56305	I56325	I56315	I56105	I56205	I56225 SX I56215 DX
OCEAN BLUE	I56004	I56036	I56016	I56026	I56046	I56336	I56306	I56326	I56316	I56106	I56206	I56226 SX I56216 DX
IVORY	I56001	I56033	I56013	I56023	I56043	I56333	I56303	I56323	I56313	I56103	I56203	I56223 SX I56213 DX
GREIGE	I56002	I56032	I56012	I56022	I56042	I56332	I56302	I56322	I56312	I56102	I56202	I56222 SX I56212 DX
COPPER	I56003	I56034	I56014	I56024	I56044	I56334	I56304	I56324	I56314	I56104	I56204	I56224 SX I56214 DX
PREZZO PRICE	€ 46,00 m <sup>2</sup>	€ 46,00 m <sup>2</sup>	€ 38,00 m <sup>2</sup>	€ 34,00 m <sup>2</sup>	€ 37,00 m <sup>2</sup>	€ 272,00 m <sup>2</sup>	€ 110,00 m <sup>2</sup>	€ 126,00 m <sup>2</sup>	€ 132,00 m <sup>2</sup>	€ 5,00 PZ/PCE	€ 140,00 PZ/PCE	€ 164,00 PZ/PCE
CODICE PREZZO PRICE CODE	M109	M109	M093	M085	M091	M303	M177	M193	M199	P017	P207	P231
	<b>Epal</b> 80x120	<b>Epal</b> 80x120	<b>Epal</b> 80x120	<b>Epal</b> 80x120	<b>Epal</b> 80x120	<b>Epal</b> 80x120	<b>Epal</b> 80x120	<b>Epal</b> 80x120	<b>Epal</b> 80x120	<b>Epal</b> 80x120	<b>Epal</b> 80x120	<b>Epal</b> 80x120
IMBALLO cm h. PACKING cm h.	75	70	75	75	57	-	-	-	-	-	-	-
 x 	2	4	3	7	58	6	6	6	6	15	2	1
m <sup>2</sup> x 	1,44	0,96	1,08	1,26	1,8	0,48	0,42	0,54	0,54	0,63	-	-
Kg x 	33,12	18,40	25,38	24,00	17,4	9,41	8,7	10,36	10,36	13,28	23,00	12,00
 x 	32	60	40	48	60	60	60	60	60	-	-	-
m <sup>2</sup> x 	46,08	57,60	43,20	60,48	64,8	28,80	25,20	32,40	32,40	-	-	-
Kg x 	1.080	1.124	1.035	1.172	1.064	584,60	504,20	641,60	641,60	-	-	-

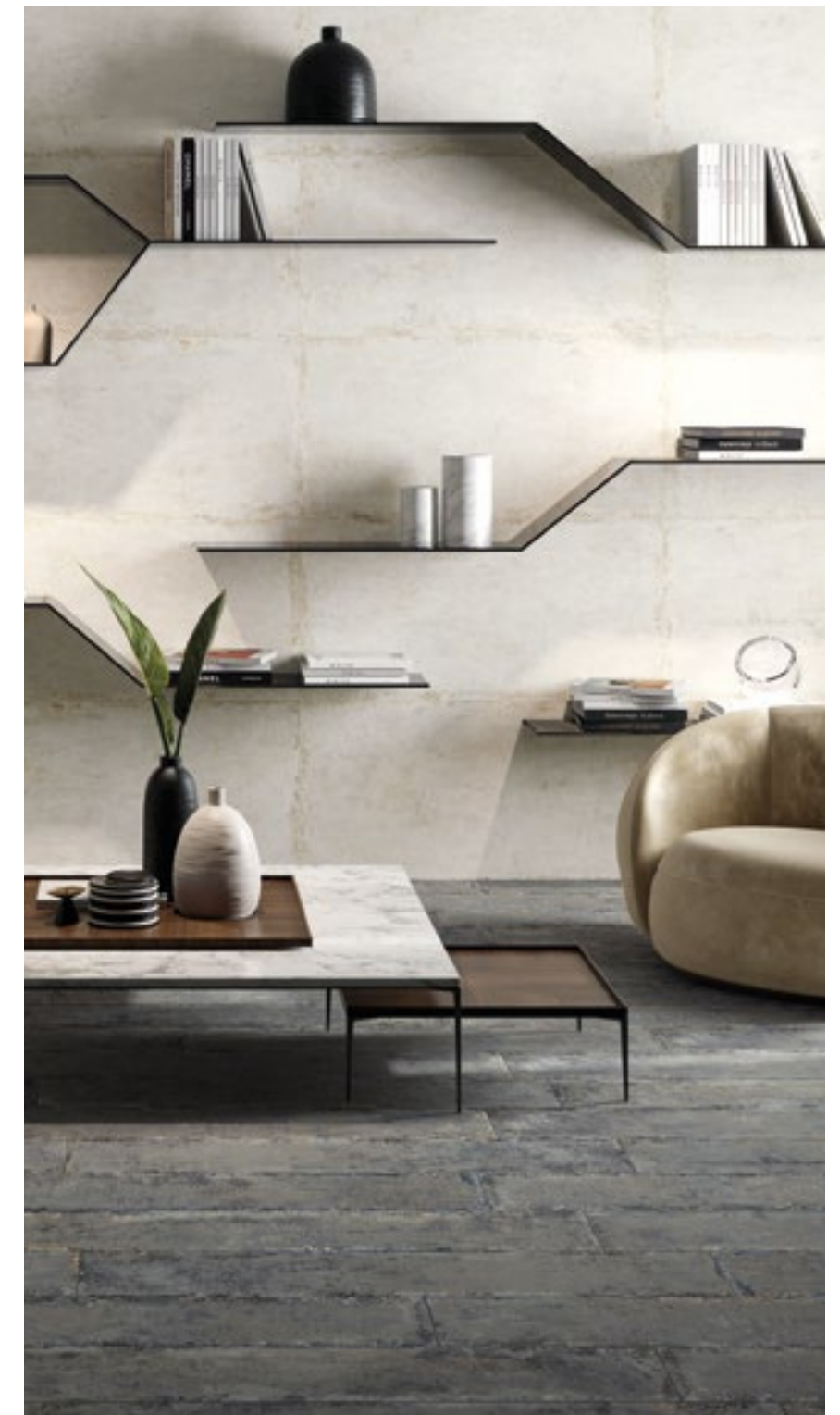

Wall  
Ivory 60x120 (24"x48") Nat. Ret.

Floor  
Sage 20x120 (8"x48") Nat. Ret.

\*\* A DISPOSIZIONE SOLO SU RICHIESTA. TEMPI DI CONSEGNA: 30GG.

Available upon request only. Delivery terms: 30 days.  
Disponible seulement sur requête. Délais de livraison: 30 jours.  
Verfügbar auf Anfrage. Lieferzeit: 30 Tage.  
Disponibile sólo bajo pedido. Plazo de entrega: 30 días.  
Изготавливается только по специальной заявке. Срок поставки: 30 дней.

PER IL GRADINO NON SI GARANTISCE LA STESSA TONALITÀ DEL FONDO.

We cannot guarantee that the shade of the stair tile will be the same as the background tile.  
Pour la marche, nous ne garantissons pas la même tonalité du fond.  
Für die Stufe wird nicht der gleiche Farbton der Grundfliese garantiert.  
Para el peldaño no se garantiza el mismo tono del fondo.  
Для ступени не гарантирована одинаковость тона с фоном.

ATTENZIONE: Per un risultato ottimale si consiglia di utilizzare durante la posa i cunei.

ATTENTION: For a perfect result, we recommend you use wedges during laying.  
ATTENTION: Nous conseillons d'utiliser les coins durant la pose pour un résultat optimal.  
WARNUNG: Für ein ausgezeichnetes Ergebnis wird empfohlen, bei der Verlegung die Keile zu verwenden.  
ATENCIÓN: Para obtener un resultado optimizado se aconseja utilizar las cuñas durante la colocación.  
ВНИМАНИЕ: Для получения оптимального результата рекомендуется использовать клинья во время укладки.

ATTENZIONE: Si consiglia di mantenere una fuga di 3 mm per la posa in multiformato degli articoli rettificati.

ATTENTION: In the case of straightened-edge tiles, we recommend you keep a 3 mm joint when laying different-sized tiles together.  
ATTENTION: Il est recommandé de maintenir un joint de 3 mm pour la pose en multiformat des articles rectifiés.  
WARNUNG: Es wird geraten, eine Fuge von 3 mm bei der Verlegung der geschliffenen Artikel als Multiformat einzuhalten.  
ATENCIÓN: Se aconseja mantener una junta de 3 mm para la colocación en multiformato de los artículos rectificados.  
ВНИМАНИЕ: Рекомендуем оставлять шов 3 мм при укладке обрезной продукции нескольких форматов.

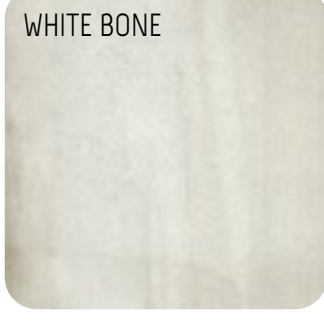
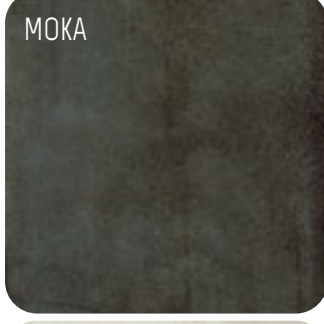

Wall: Teal 6,1x37 (2 1/2"x14 1/2") Nat. - White Dust 6,1x37 (2 1/2"x14 1/2") Nat. / Floor: Amazon Arara 20x20 (8"x8") Nat.Ret.



# BRUSH

GRES PORCELLANATO . PORCELAIN TILES  
GRES CÉRAMÉ . FEINSTEINZEUG  
GRES PORCELÁNICO . КЕРАМОГРАНИТ  
ISO 13006 - G - B1a (E ≤ 0,5%) - UNI EN 14411 - G

100% DESIGN  
AND PRODUCTION  
OF ITALY

V2  
SHADE SPECTRUM  
MODERATE

INDOOR

6,1x37 . 2 1/2"x14 1/2"  
Nat. 6 mm

SVILUPPO GRAFICO PER FORMATO  
Pattern by size  
Développement graphique par format  
Grafischer Entwurf für Format  
Desarrollo gráfico por formato  
Варианты графики для каждого формата

6,1x37  
6 mm  
28

# BRUSH

6 mm



Wall  
White Bone 6,ix37 (2 1/2"x14 1/2") Nat.  
Moka 6,ix37 (2 1/2"x14 1/2") Nat.

Floor  
High Line Chelsea 60x60 (24"x24") Lap. Ret.

Wall  
Brush White Dust 6,ix37 (2 1/2"x14 1/2") Nat.

Floor  
Space Cement 80x80 (31 1/2"x31 1/2") Nat. Ret.

# BRUSH

## DENIM

INDOOR



6 mm

I45006  
6,ix37 . 2 1/2"x14 1/2"  
Nat.

## TEAL

INDOOR



6 mm

I45004  
6,ix37 . 2 1/2"x14 1/2"  
Nat.

## MOKA

INDOOR



6 mm

I45002  
6,ix37 . 2 1/2"x14 1/2"  
Nat.

## WHITE FROST

INDOOR



6 mm

I45005  
6,ix37 . 2 1/2"x14 1/2"  
Nat.

## WHITE DUST

INDOOR



6 mm

I45003  
6,ix37 . 2 1/2"x14 1/2"  
Nat.

## WHITE BONE

INDOOR



6 mm

I45001  
6,ix37 . 2 1/2"x14 1/2"  
Nat.



Wall  
White Dust 6,ix37 (2 1/2"x14 1/2") Nat.  
Teal 6,ix37 (2 1/2"x14 1/2") Nat.

Floor  
Kauri Awanui 20x120 (8"x48") Lap. Ret.

# BRUSH

6 mm

ANSI A - 137.1: 2012  
WET DYNAMIC COEFFICIENT OF FRICTION | DCOF ≥ 0,42

			6,1x37 2 1/2"x14 1/2" Nat.
DENIM		I45006	
WHITE FROST		I45005	
TEAL		I45004	
WHITE DUST		I45003	
MOKA		I45002	
WHITE BONE		I45001	
	PREZZO PRICE	€ 37,00 m <sup>2</sup>	
	CODICE PREZZO PRICE CODE	M091	
			Epal 80x120
	IMBALLO cm h. PACKING cm h.	57	
	 x 	62	
	m <sup>2</sup> x 	1,40	
	Kg x 	22,54	
	 x 	60	
	m <sup>2</sup> x 	84	
	Kg x 	1.372	



Wall  
Denim 6,1x37 (2 1/2"x14 1/2") Nat.  
White Frost 6,1x37 (2 1/2"x14 1/2") Nat.

Floor  
Ca Foscari Lino 20x120 (8"x48") Nat. Ret.

SI CONSIGLIA DI MANTENERE UNA FUGA DI 2 MM.  
We recommend you keep a 2 mm joint.  
On conseille de préserver un joint de 2 mm.  
Es wird geraten, eine Fuge von 2 mm bei der Verlegung.  
Se aconseja mantener una junta de 2 mm.  
форматов. Рекомендуем оставлять межплиточный шов 2 мм.





Wall: Brush White Bone 6,1x37 (2 1/2"x41 1/2") Nat. | Floor: Bruno 40,6x40,6 (16"x16") Nat. - Bruno 20,3x20,3 (8"x8") Nat.



# COTTO DEL CASALE

GRES PORCELLANATO . PORCELAIN TILES  
GRES CÉRAMÉ . FEINSTEINZEUG  
GRES PORCELÁNICO . КЕРАМОГРАФИТ  
ISO 13006 - G - Bl-a (E ≤ 0,5%) - UNI EN 14411 - G

100% DESIGN  
AND PRODUCTION  
OF ITALY

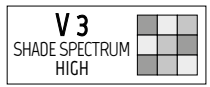

## INDOOR

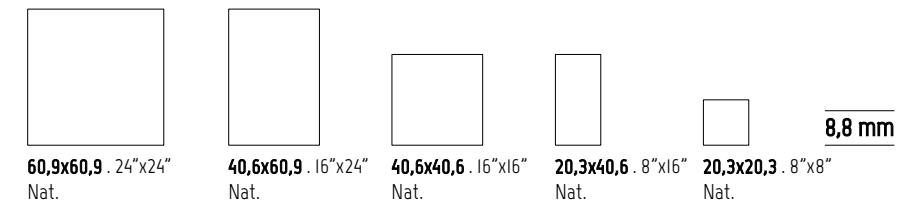

modular system



**Decoro Capri**  
20,3x20,3 . 8"x8"  
Luc.



**Decoro Pompei**  
20,3x20,3 . 8"x8"  
Sat.



**Decoro Pompei fascia**  
10x40,6 . 4"x16"  
Sat.

## OUTDOOR

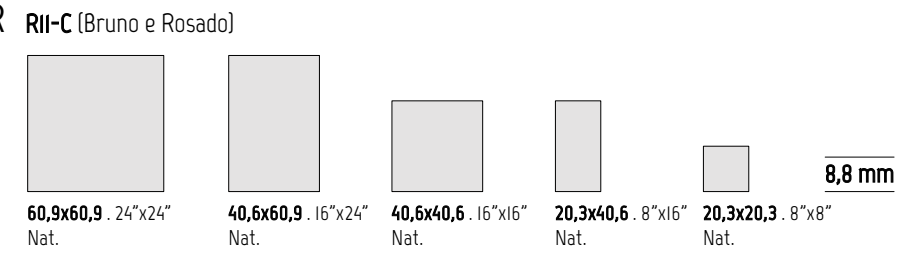

modular system

SVILUPPO GRAFICO PER FORMATO Pattern by size Développement graphique par format Grafischer Entwurf für Format Desarrollo gráfico por formato Варианты графики для каждого формата	60,9x60,9 8,8 mm	40,6x60,9 8,8 mm	40,6x40,6 8,8 mm	20,3x40,6 8,8 mm	20,3x20,3 8,8 mm
	16	27	35	55	55

# COTTO DEL CASALE

8,8 mm



Floor  
 Bruno 60,9x60,9 (24"x24") Nat.  
 40,6x40,6 (16"x16") Nat.  
 20,3x40,6 (8"x16") Nat.  
 20,3x20,3 (8"x8") Nat.  
 Decoro Pompei 20,3x20,3 (8"x8") Luc.

Wall  
 Brush White Frost 6,1x37 (2 1/2"x14 1/2") Nat.  
 Brush Denim 6,1x37 (2 1/2"x14 1/2") Nat.

Floor  
 Rosado 60,9x60,9 (24"x24") Nat.  
 40,6x40,6 (16"x16") Nat.  
 20,3x40,6 (8"x16") Nat.  
 20,3x20,3 (8"x8") Nat.  
 Decoro Pompei 20,3x20,3 (8"x8") Sat.

# COTTO DEL CASALE

## BRUNO

INDOOR

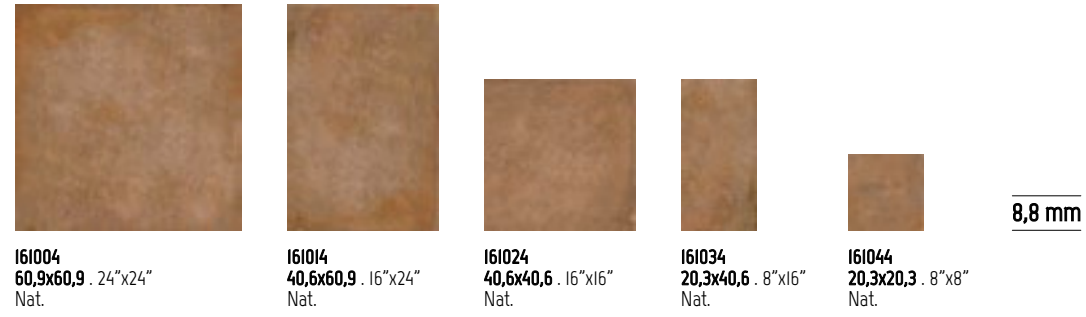

**161004**  
60,9x60,9 . 24"x24"  
Nat.

**161014**  
40,6x60,9 . 16"x24"  
Nat.

**161024**  
40,6x40,6 . 16"x16"  
Nat.

**161034**  
20,3x40,6 . 8"x16"  
Nat.

**161044**  
20,3x20,3 . 8"x8"  
Nat.

8,8 mm

modular system



**161302**  
Decoro Capri  
20,3x20,3 . 8"x8"  
Luc.

**161301**  
Decoro Pompei  
20,3x20,3 . 8"x8"  
Sat.

**161303**  
Pompei Fascia  
10x40 . 4"x16"  
Sat.

## OUTDOOR

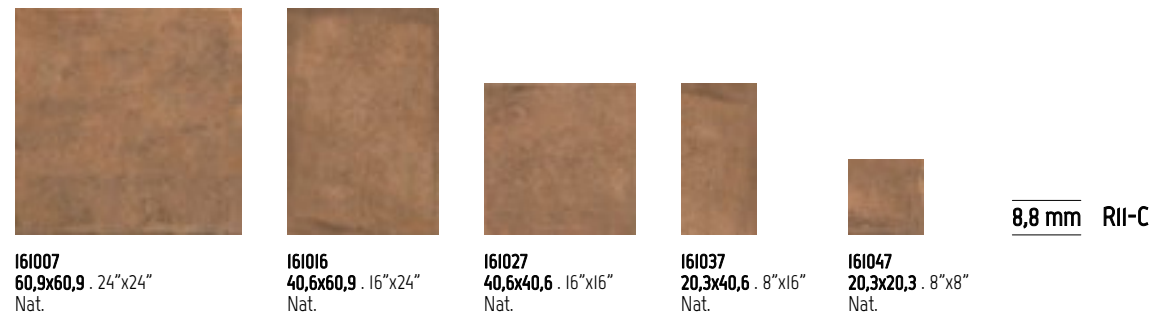

**161007**  
60,9x60,9 . 24"x24"  
Nat.

**161016**  
40,6x60,9 . 16"x24"  
Nat.

**161027**  
40,6x40,6 . 16"x16"  
Nat.

**161037**  
20,3x40,6 . 8"x16"  
Nat.

**161047**  
20,3x20,3 . 8"x8"  
Nat.

8,8 mm RII-C

modular system

## ROSADO

INDOOR

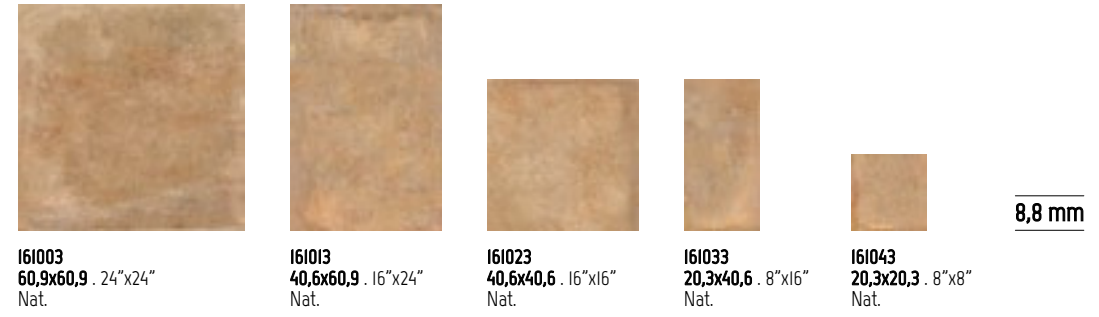

**161003**  
60,9x60,9 . 24"x24"  
Nat.

**161013**  
40,6x60,9 . 16"x24"  
Nat.

**161023**  
40,6x40,6 . 16"x16"  
Nat.

**161033**  
20,3x40,6 . 8"x16"  
Nat.

**161043**  
20,3x20,3 . 8"x8"  
Nat.

8,8 mm

modular system

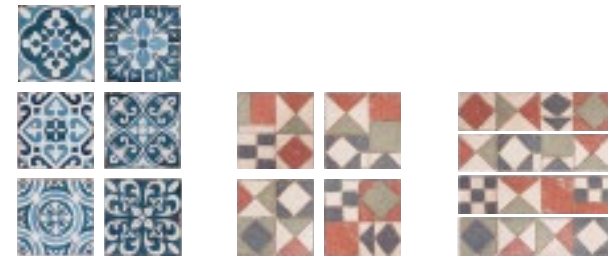

**161302**  
Decoro Capri  
20,3x20,3 . 8"x8"  
Luc.

**161301**  
Decoro Pompei  
20,3x20,3 . 8"x8"  
Sat.

**161303**  
Pompei Fascia  
10x40 . 4"x16"  
Sat.

## OUTDOOR

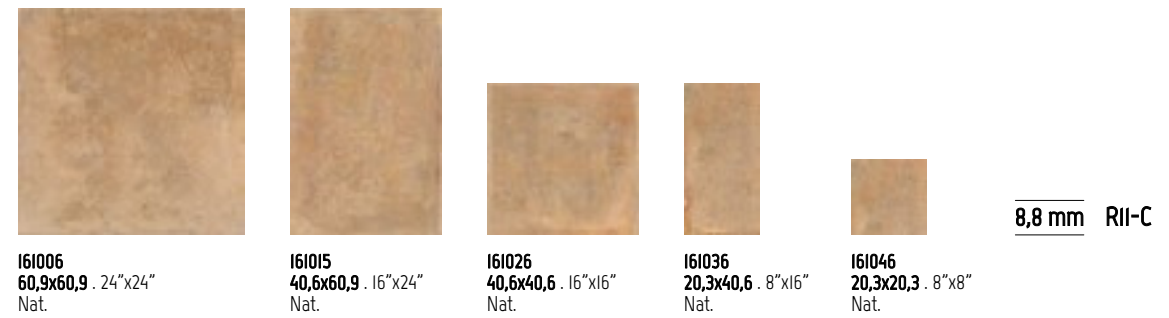

**161006**  
60,9x60,9 . 24"x24"  
Nat.

**161015**  
40,6x60,9 . 16"x24"  
Nat.

**161026**  
40,6x40,6 . 16"x16"  
Nat.

**161036**  
20,3x40,6 . 8"x16"  
Nat.

**161046**  
20,3x20,3 . 8"x8"  
Nat.

8,8 mm RII-C

modular system

# COTTO DEL CASALE

## OCRA

INDOOR



**161002**  
60,9x60,9 . 24"x24"  
Nat.

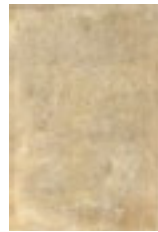

**161012**  
40,6x60,9 . 16"x24"  
Nat.



**161022**  
40,6x40,6 . 16"x16"  
Nat.



**161032**  
20,3x40,6 . 8"x16"  
Nat.



**161042**  
20,3x20,3 . 8"x8"  
Nat.

8,8 mm

modular system



**161302**  
Decoro Capri  
20,3x20,3 . 8"x8"  
Luc.

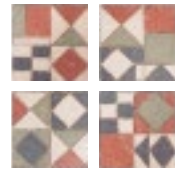

**161301**  
Decoro Pompei  
20,3x20,3 . 8"x8"  
Sat.



**161303**  
Pompei Fascia  
10x40 . 4"x16"  
Sat.

## GREIGE

INDOOR



**161001**  
60,9x60,9 . 24"x24"  
Nat.



**161011**  
40,6x60,9 . 16"x24"  
Nat.



**161021**  
40,6x40,6 . 16"x16"  
Nat.



**161031**  
20,3x40,6 . 8"x16"  
Nat.



**161041**  
20,3x20,3 . 8"x8"  
Nat.

8,8 mm

modular system



**161302**  
Decoro Capri  
20,3x20,3 . 8"x8"  
Luc.

























**161301**  
Decoro Pompei  
20,3x20,3 . 8"x8"  
Sat.



**161303**  
Pompei Fascia  
10x40 . 4"x16"  
Sat.

# COTTO DEL CASALE

8,8 mm

	modular system					Decoro Capri Mix 6 Capri Mix 6 decorative tile *	Decoro Pompei Mix 4 Pompei Mix 4 decorative tile *	Pompei Fascia Mix 4 Pompei band Mix 4 *	Battiscopa Skirting		Gradino costa retta Straight-edge step **	Gradino costa retta - Angolo SX / DX Straight-edge step - LH/RH corner **		
														
	60,9x60,9 24"x24" Nat.	40,6x60,9 16"x24" Nat.	40,6x40,6 16"x16" Nat.	20,3x40,6 8"x16" Nat.	20x20 8"x8" Nat.	20,3x20,3 8"x8" Luc.	20,3x20,3 8"x8" Sat.	10x40 4"x16" Sat.	7x60,9 3"x24" Nat.		33x60,9x3,2h 13"x24"x1 1/4" Nat.	33x60,9x3,2h 13"x24"x1 1/4" Nat.		
BRUNO 	161004	161014	161024	161034	161044	161302	161301	161303	161104		161204	161224 SX 161214 DX		
ROSADO 	161003	161013	161023	161033	161043				161103		161203		161223 SX 161213 DX	
OCRA 	161002	161012	161022	161032	161042				161102		161202		161222 SX 161212 DX	
GREIGE 	161001	161011	161021	161031	161041				161101		161201		161221 SX 161211 DX	
PREZZO PRICE	€ 33,00 m <sup>2</sup>	€ 33,00 m <sup>2</sup>	€ 33,00 m <sup>2</sup>	€ 33,00 m <sup>2</sup>	€ 33,00 m <sup>2</sup>	€ 70,00 CP	€ 45,00 CP	€ 58,00 CP	€ 5,00 PZ/PCE		€ 68,00 PZ/PCE	€ 100,00 PZ/PCE		
CODICE PREZZO PRICE CODE	M083	M083	M083	M083	M083	PI37	PI07	PI25	PI07		PI35	PI67		
	<b>Epal</b> 80x120	<b>Epal</b> 80x120	<b>Epal</b> 80x120	<b>Epal</b> 80x120	<b>Epal</b> 80x120	<b>Epal</b> 80x120	<b>Epal</b> 80x120	<b>Epal</b> 80x120	<b>Epal</b> 80x120		<b>Epal</b> 80x120	<b>Epal</b> 80x120		
IMBALLO cm h. PACKING cm h.	75	96	96	96	96	-	-	-	-		-	-		
 x 	3	6	6	13	30	6	4	6	15		4	2		
m <sup>2</sup> x 	1,11	1,48	0,99	1,07	1,24	0,24	0,16	0,16	0,63		-	-		
Kg x 	20,6	31,6	21,63	23,38	27,09	5,65	4,05	4,10	13,76		20,00	11,00		
 x 	40	40	72	72	60	-	-	-	-		-	-		
m <sup>2</sup> x 	44,40	59,2	71,28	77,04	74,4	-	-	-	-		-	-		
Kg x 	824	1.264	1.558	1.684	1.626	-	-	-	-		-	-		



Floor  
Greige 60,9x60,9 (24"x24") Nat.  
40,6x40,6 (16"x16") Nat.  
20,3x40,6 (8"x16") Nat.  
20,3x20,3 (8"x8") Nat.

\*\* A DISPOSIZIONE SOLO SU RICHIESTA. TEMPI DI CONSEGNA: 30GG.

Available upon request only. Delivery terms: 30 days.  
Disponible seulement sur requête. Délais de livraison: 30 jours.  
Verfügbar auf Anfrage. Lieferzeit: 30 Tage.  
Disponibile sólo bajo pedido. Plazo de entrega: 30 días.  
Изготавливается только по специальной заявке. Срок поставки: 30 дней.

PER IL GRADINO NON SI GARANTISCE LA STESSA TONALITÀ DEL FONDO.

We cannot guarantee that the shade of the stair tile will be the same as the background tile.  
Pour la marche, nous ne garantissons pas la même tonalité du fond.  
Für die Stufe wird nicht der gleiche Farbton der Grundfliese garantiert.  
Para el peldaño no se garantiza el mismo tono del fondo.  
Для ступени не гарантирована одинаковость тона с фоном.

ATTENZIONE: Per un risultato ottimale si consiglia di utilizzare durante la posa i cunei.

ATTENTION: For a perfect result, we recommend you use wedges during laying.  
ATTENTION: Nous conseillons d'utiliser les coins durant la pose pour un résultat optimal.  
WARNUNG: Für ein ausgezeichnetes Ergebnis wird empfohlen, bei der Verlegung die Keile zu verwenden.  
ATENCIÓN: Para obtener un resultado optimizado se aconseja utilizar las cuñas durante la colocación.  
ВНИМАНИЕ: Для получения оптимального результата рекомендуется использовать клинья во время укладки.

\* IN OGNI SCATOLA LA COMBINAZIONE DEI SOGGETTI È DEL TUTTO CASUALE. LO STESSO SOGGETTO POTREBBE ESSERE RIPETUTO OPPURE POTREBBE NON ESSERE PRESENTE NELLA SCATOLA.

















Each box contains a random assortment of the designs available. The same design may be repeated and certain designs may not be included in the box.  
La combinación de motivos à l'intérieur de chaque boîte est absolument fortuite. Le même motif pourrait être répété ou ne pas se trouver à l'intérieur de la boîte.  
Die Zusammenstellung der Motive ist in jedem Karton vollkommen zufällig. Das selbe Motiv könnte sich wiederholen oder nicht im Karton vorhanden sein.  
En cada caja la combinación de los temas es del todo casual. En una caja un tema puede estar repetido o estar ausente.  
Сочетание мотивов в каждой коробке является совершенно случайным. Один и тот же мотив может присутствовать в коробке несколько раз или, наоборот, отсутствовать.

ATTENZIONE: Si consiglia di mantenere una fuga di 3 mm per la posa in multiformato degli articoli rettificati.

ATTENTION: In the case of straightened-edge tiles, we recommend you keep a 3 mm joint when laying different-sized tiles together.  
ATTENTION: Il est recommandé de maintenir un joint de 3 mm pour la pose en multiformat des articles rectifiés.  
WARNUNG: Es wird geraten, eine Fuge von 3 mm bei der Verlegung der geschliffenen Artikel als Multiformat einzuhalten.  
ATENCIÓN: Se aconseja mantener una junta de 3 mm para la colocación en multiformato de los artículos rectificados.  
ВНИМАНИЕ: Рекомендуем оставлять шов 3 мм при укладке обрезной продукции нескольких форматов.

# COTTO DEL CASALE

8,8 mm RII-C

		modular system					Elle monolitico estruso Extruded L-shaped monoblock tile
							
		60,9x60,9 24"x24" Nat.	40,6x60,9 16"x24" Nat.	40,6x40,6 16"x16" Nat.	20,3x40,6 8"x16" Nat.	20x20 8"x8" Nat.	10x40,6x5 4"x16"x2" Nat.
BRUNO		161007	161016	161027	161037	161047	161402
ROSADO		161006	161015	161026	161036	161046	161401
PREZZO PRICE		€ 33,00 m <sup>2</sup>	€ 33,00 m <sup>2</sup>	€ 33,00 m <sup>2</sup>	€ 33,00 m <sup>2</sup>	€ 33,00 m <sup>2</sup>	€ 19,00 m <sup>2</sup>
CODICE PREZZO PRICE CODE		M083	M083	M083	M083	M083	P050
		<b>Epat</b> 80x120	<b>Epat</b> 80x120	<b>Epat</b> 80x120	<b>Epat</b> 80x120	<b>Epat</b> 80x120	<b>Epat</b> 80x120
IMBALLO cm h. PACKING cm h.		75	96	96	96	96	75
	 x 	3	6	6	13	30	8
	m <sup>2</sup> x 	1,11	1,48	0,99	1,07	1,24	0,32
	Kg x 	20,6	31,6	21,63	23,38	27,09	8,2
	 x 	40	40	72	72	60	36
	m <sup>2</sup> x 	44,40	59,2	71,28	77,04	74,4	11,52
	Kg x 	824	1.264	1.558	1.684	1.626	296



Floor  
 Ocra 60,9x60,9 (24"x24") Nat.  
 40,6x40,6 (16"x16") Nat.  
 20,3x40,6 (8"x16") Nat.  
 20,3x20,3 (8"x8") Nat.  
 Decoro Pompei Fascia 10x40 (4"x16") Sat.

Wall  
 Brush Teal 3,1x37 (2 1/2"x14 1/2")

TITANIUM

PLATINUM

IRIDIUM

# FUSION

Floor: Platinum 60x60 (24"x24") Lap. Strut. Ret. - Muretto Platinum 16,2x49 (6 1/4"x19 1/2") Lap. Strut. Ret.



GRES PORCELLANATO COLORATO IN MASSA . COLORED BODY PORCELAIN STONWARE  
GRES CÉRAMÉ COLORÉ DANS LA MASSE . EINGEFÄRBTES FEINSTEINZEUG  
GRES PORCELÁNICO COLOREADO EN MASA . КЕРАМОГРАНИТ ОКРАШЕННЫЙ В МАССЕ  
ISO 13006 - G - B1a (E ≤ 0,5%) - UNI EN 14411 - G

FLOOR TILE OF THE YEAR 2009



100% DESIGN AND PRODUCTION OF ITALY

V2  
SHADE SPECTRUM MODERATE

## INDOOR R10-A (Titanium / Platinum)



60x60 . 24"x24"  
Lap. Liscia Ret.  
60x60 . 24"x24"  
Lap. Strut. Ret.

11 mm



Mosaico  
32,6x32,6 . 13"x13"  
Lap. Liscia Ret.  
Mosaico  
32,6x32,6 . 13"x13"  
Lap. Strut. Ret.



Mosaico  
32,6x32,6 . 13"x13"  
Lap. Liscia Ret.  
Mosaico  
32,6x32,6 . 13"x13"  
Lap. Strut. Ret.

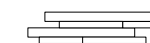

Muretto su rete  
16,2x49 . 6 1/4"x19 1/2"  
Lap. Liscia Ret.  
Muretto su rete  
16,2x49 . 6 1/4"x19 1/2"  
Lap. Strut. Ret.

12 mm

SVILUPPO GRAFICO RANDOM (TECNOLOGIA A RULLO)  
Random pattern (roller technology)  
Développement graphique aléatoire (technologie à rouleau)  
Zufälliger grafischer Entwurf (Technologie mit Rolle)  
Desarrollo gráfico aleatorio (tecnología de rodillo)  
Произвольные варианты графики (технология с применением валика)

# FUSION

11 mm RIO-A (Titanium / Platinum)



Wall  
Mosaico Iridium 32,6x32,6 . (13"x13") Lap. Liscia Ret.

Floor  
Iridium 60x60 (24"x24") Lap. Liscia Ret.  
Titanium 60x60 (24"x24") Lap. Strut. Ret.



# FUSION

## TITANIUM

INDOOR



11 mm RIO-A

**6L01**  
60x60 . 24"x24"  
Lap. Liscia Ret.

**6L05**  
60x60 . 24"x24"  
Lap. Strut. Ret.

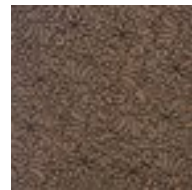

12 mm RIO-A

**L650**  
Diamond Glittery  
49x49 . 19 1/2"x19 1/2"  
Lap. Liscia Ret.

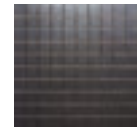

**9241**  
Mosaico  
32,6x32,6 . 13"x13"  
Lap. Liscia Ret.



**9244**  
Mosaico  
32,6x32,6 . 13"x13"  
Lap. Liscia Ret.



**L578**  
Muretto  
16,2x49 . 6 1/4"x19 1/2"  
Lap. Liscia Ret.

**L579**  
Muretto  
16,2x49 . 6 1/4"x19 1/2"  
Lap. Strut. Ret.

## IRIDIUM

INDOOR

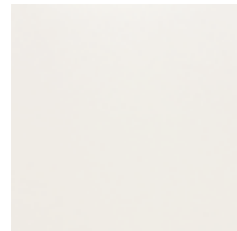

11 mm

**6L00**  
60x60 . 24"x24"  
Lap. Liscia Ret.

**6L02**  
60x60 . 24"x24"  
Lap. Strut. Ret.

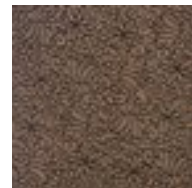

12 mm

**L650**  
Decoro Glittery  
49x49 . 19 1/2"x19 1/2"  
Lap. Liscia Ret.



**9240**  
Mosaico  
32,6x32,6 . 13"x13"  
Lap. Liscia Ret.

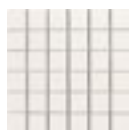

**9243**  
Mosaico  
32,6x32,6 . 13"x13"  
Lap. Liscia Ret.



**L577**  
Muretto  
16,2x49 . 6 1/4"x19 1/2"  
Lap. Liscia Ret.

**L453**  
Muretto  
16,2x49 . 6 1/4"x19 1/2"  
Lap. Strut. Ret.

## PLATINUM

INDOOR



11 mm RIO-A

**6L04**  
60x60 . 24"x24"  
Lap. Strut. Ret.



**L650**  
Diamond Glittery  
49x49 . 19 1/2"x19 1/2"  
Lap. Liscia Ret.



**9154**  
Mosaico  
32,6x32,6 . 13"x13"  
Lap. Liscia Ret.



**9157**  
Mosaico  
32,6x32,6 . 13"x13"  
Lap. Strut. Ret.



**9210**  
Mosaico  
32,6x32,6 . 13"x13"  
Lap. Liscia Ret.

**9213**  
Mosaico  
32,6x32,6 . 13"x13"  
Lap. Strut. Ret.



























**L451**  
Muretto  
16,2x49 . 6 1/4"x19 1/2"  
Lap. Liscia Ret.

**L454**  
Muretto  
16,2x49 . 6 1/4"x19 1/2"  
Lap. Strut. Ret.

# FUSION

## 11 mm RIO-A (Titanium / Platinum)

	Decoro Diamond Glittery Diamond Glittery decorative tile		Mosaico Mosaic	Mosaico Mosaic	Muretto su rete Brick effect mosaic	Battiscopa Skirting	Gradino costa retta Straight-edge step **	Gradino costa retta - Angolo SX / DX Straight-edge step - LH/RH corner **								
	 60x60 24"x24" Lap. Liscia Ret.	 60x60 24"x24" Lap. Strut. Ret.	 49x49 19 1/2"x19 1/2" Lap. Liscia Ret.	 32,6x32,6 13"x13" Lap. Liscia Ret.	 32,6x32,6 13"x13" Lap. Strut. Ret.	 16,2x49 6 1/4"x19 1/2" Lap. Liscia Ret.	 16,2x49 6 1/4"x19 1/2" Lap. Strut. Ret.	 9,5x60 3 3/4"x24" Lap. Liscia Ret.	 9,5x60 3 3/4"x24" Lap. Strut. Ret.	 33x60x3,2h 13"x24"x1 1/4" Lap. Liscia Ret.	 33x60x3,2h 13"x24"x1 1/4" Lap. Strut. Ret.	 33x60x3,2h 13"x24"x1 1/4" Lap. Liscia Ret.	 33x60x3,2h 13"x24"x1 1/4" Lap. Strut. Ret.			
TITANIUM 	6L01	6L05	L650	9244	9245	9241	9242	L578	L579			K40L08A	K40S08A	J40L08S SX J40L08D DX	J40S08S SX J40S08D DX	
PLATINIUM 	-	6L04		9210	9213	9154	9157	L451	L454	-			K40S06A	-	J40S06S SX J40S06D DX	
IRIDIUM 	6L00	6L02		9243	9212	9240	9156	L577	L453				K40L02A	K40S02A	J40L02S SX J40L02D DX	J40S02S SX J40S02D DX
PREZZO PRICE	€ 64,00 m <sup>2</sup>		€ 120,00 PZ/PCE	€ 120,00 m <sup>2</sup>		€ 120,00 m <sup>2</sup>		€ 118,00 m <sup>2</sup>		€ 6,00 PZ/PCE		€ 76,00 PZ/PCE		€ 106,00 PZ/PCE		
CODICE PREZZO PRICE CODE	M131		PI87	M187		M187		M185		P021		PI43		PI73		
	Epal 80x120		Epal 80x120	Epal 80x120		Epal 80x120		Epal 80x120		Epal 80x120		Epal 80x120		Epal 80x120		
IMBALLO cm h. PACKING cm h.	75		-	73		75		80		-		-		-		
 x 	3		2	4		5		5		12		4		4		
m <sup>2</sup> x 	1,08		-	0,43		0,53		0,40		-		-		-		
Kg x 	27,54		12,00	10,50		12,70		10,00		18,00		24,00		26,00		
 x 	32		-	72		60		70		-		-		-		
m <sup>2</sup> x 	34,56		-	30,96		31,80		28,00		-		-		-		
Kg x 	901		-	776		782		720		-		-		-		

### \*\* A DISPOSIZIONE SOLO SU RICHIESTA. TEMPI DI CONSEGNA: 30GG.

Available upon request only. Delivery terms: 30 days.  
 Disponible seulement sur requête. Délais de livraison: 30 jours.  
 Verfügbar auf Anfrage. Lieferzeit: 30 Tage.  
 Disponible sólo bajo pedido. Plazo de entrega: 30 días.  
 Изготавливается только по специальной заявке. Срок поставки: 30 дней.

### PER IL GRADINO NON SI GARANTISCE LA STESSA TONALITÀ DEL FONDO.

We cannot guarantee that the shade of the stair tile will be the same as the background tile.  
 Pour la marche, nous ne garantissons pas la même tonalité du fond.  
 Für die Stufe wird nicht der gleiche Farbton der Grundfliese garantiert.  
 Para el peldaño no se garantiza el mismo tono del fondo.  
 Для ступени не гарантирована одинаковость тона с фоном.

### TUTTI I DECORI SI ABBINANO AL FONDO MA POSSONO ESSERE DI TONALITÀ DIVERSE.

All decorations match the base but may be of a different tone.  
 Tous les décors sont assortis au fond, mais les tonalités peuvent être différentes.  
 Alle Dekore passen zur Unifliese, können jedoch unterschiedliche Farbtöne aufweisen.  
 Todas las decoraciones se combinan con el fondo pero pueden ser de tonalidades diferentes.  
 Все декоры сочетаются с фоновой плиткой, но могут быть разных тонов.

### ATTENZIONE: Si consiglia fortemente di pulire bene la superficie delle piastrelle strutturate immediatamente dopo aver fucato il pavimento.

Questa operazione eviterà al materiale usato per la fuga di solidificarsi all'interno delle cavità presenti nella superficie della piastrella.  
 N.B. We strongly recommended you thoroughly clean the surface of textured floor tiles immediately after filling the joints.

This will prevent the filler solidifying in the cavities found in the tiles' surface.  
 ATTENTION : Il est vivement recommandé de bien nettoyer la surface des carreaux structurés, immédiatement après le jointoyage.  
 Cette opération empêchera le matériel utilisé pour le jointoyage de se solidifier à l'intérieur des cavités présentes à la surface des carreaux.

ACHTUNG: Es wird dringend geraten, die Oberfläche der strukturierten Fliesen sofort nach dem Verfugen des Bodenbelags gut zu reinigen.  
 Dieser Vorgang verhindert, dass das zum Verfugen verwendete Material innerhalb der in der Fliesenoberfläche vorhandenen Hohlräume aushärten kann.  
 ATENCIÓN: Se aconseja fuertemente limpiar de modo eficaz la superficie de las baldosas estructuradas, inmediatamente después de haber aplicado las juntas al pavimento.

Esta operación evitará que las trazas excedentes del material aplicado en las juntas se solidifiquen en el interior de las cavidades presentes en la superficie de las baldosas.  
**ВНИМАНИЕ:** Настоятельно рекомендуем хорошо очистить поверхность структурированной плитки сразу же после заделки швов на полу.  
 Таким образом, используемый для заделки швов материал не отвердеет в неровностях, имеющихся на поверхности плитки.

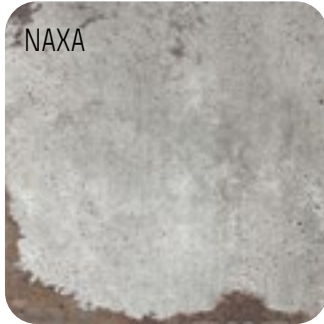

Floor: Kimberly 30x120 (12"x48") Nat. Ret.

GRES PORCELLANATO COLORATO IN MASSA . COLORED BODY PORCELAIN STONEWARE  
 GRÉS CÉRAMÉ COLORÉ DANS LA MASSE . EINGEFÄRBTES FEINSTEINZEUG  
 GRES PORCELÁNICO COLOREADO EN MASA . КЕРАМОГРАНИТ ОКРАШЕННЫЙ В МАССЕ  
 ISO 13006 - G - B1a (E ≤ 0,5%) - UNI EN 14411 - G

100% DESIGN  
AND PRODUCTION  
OF ITALY

V3  
SHADE SPECTRUM  
HIGH

INDOOR

R10-A (naturale)



60x120 . 24"x48"  
Nat. Ret.  
60x120 . 24"x48"  
Lap. Ret.



30x120 . 12"x48"  
Nat. Ret.  
30x120 . 12"x48"  
Lap. Ret.



20x120 . 8"x48"  
Nat. Ret.  
20x120 . 8"x48"  
Lap. Ret.

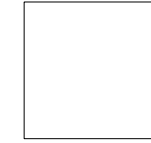

60x60 . 24"x24"  
Nat. Ret.  
60x60 . 24"x24"  
Lap. Ret.



30x60 . 12"x24"  
Nat. Ret.  
30x60 . 12"x24"  
Lap. Ret.



Mosaico  
30x30 . 12"x12"  
Nat. Ret.  
Mosaico  
30x30 . 12"x12"  
Lap. Ret.

10 mm

modular system

SVILUPPO GRAFICO PER FORMATO

Pattern by size  
Développement graphique par format  
Grafischer Entwurf für Format  
Desarrollo gráfico por formato  
Варианты графики для каждого формата

60x120 10 mm	30x120 10 mm	20x120 10 mm	60x60 10 mm	30x30 10 mm
23	38	68	29	33



# LASCAUX

## KIMBERLY

INDOOR



**089013**  
60x120 . 24"x48"  
Nat. Ret.  
**089014**  
60x120 . 24"x48"  
Lap. Ret.



**089033**  
30x120 . 12"x48"  
Nat. Ret.  
**089034**  
30x120 . 12"x48"  
Lap. Ret.



**089053**  
20x120 . 8"x48"  
Nat. Ret.  
**089054**  
20x120 . 8"x48"  
Lap. Ret.



**089093**  
60x60 . 24"x24"  
Nat. Ret.  
**089094**  
60x60 . 24"x24"  
Lap. Ret.



**089113**  
30x60 . 12"x24"  
Nat. Ret.  
**089114**  
30x60 . 12"x24"  
Lap. Ret.



**089173**  
Mosaico  
30x30 . 12"x12"  
Nat. Ret.  
**089174**  
Mosaico  
30x30 . 12"x12"  
Lap. Ret.

10 mm RIO-A (naturale)

modular system

## NAXA

INDOOR



**089017**  
60x120 . 24"x48"  
Nat. Ret.  
**089018**  
60x120 . 24"x48"  
Lap. Ret.



**089037**  
30x120 . 12"x48"  
Nat. Ret.  
**089038**  
30x120 . 12"x48"  
Lap. Ret.



**089057**  
20x120 . 8"x48"  
Nat. Ret.  
**089058**  
20x120 . 8"x48"  
Lap. Ret.



**089097**  
60x60 . 24"x24"  
Nat. Ret.  
**089098**  
60x60 . 24"x24"  
Lap. Ret.



**089117**  
30x60 . 12"x24"  
Nat. Ret.  
**089118**  
30x60 . 12"x24"  
Lap. Ret.



**089177**  
Mosaico  
30x30 . 12"x12"  
Nat. Ret.  
**089178**  
Mosaico  
30x30 . 12"x12"  
Lap. Ret.

10 mm RIO-A (naturale)

modular system

## JEITA

INDOOR



**089009**  
60x120 . 24"x48"  
Nat. Ret.  
**089010**  
60x120 . 24"x48"  
Lap. Ret.



**089029**  
30x120 . 12"x48"  
Nat. Ret.  
**089030**  
30x120 . 12"x48"  
Lap. Ret.



**089049**  
20x120 . 8"x48"  
Nat. Ret.  
**089050**  
20x120 . 8"x48"  
Lap. Ret.

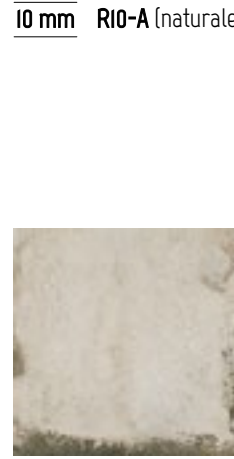

**089089**  
60x60 . 24"x24"  
Nat. Ret.  
**089090**  
60x60 . 24"x24"  
Lap. Ret.



**089109**  
30x60 . 12"x24"  
Nat. Ret.  
**089110**  
30x60 . 12"x24"  
Lap. Ret.



**089169**  
Mosaico  
30x30 . 12"x12"  
Nat. Ret.  
**089170**  
Mosaico  
30x30 . 12"x12"  
Lap. Ret.

10 mm RIO-A (naturale)

modular system

## CAPRI

INDOOR



**089001**  
60x120 . 24"x48"  
Nat. Ret.  
**089002**  
60x120 . 24"x48"  
Lap. Ret.



**089021**  
30x120 . 12"x48"  
Nat. Ret.  
**089022**  
30x120 . 12"x48"  
Lap. Ret.



**089041**  
20x120 . 8"x48"  
Nat. Ret.  
**089042**  
20x120 . 8"x48"  
Lap. Ret.

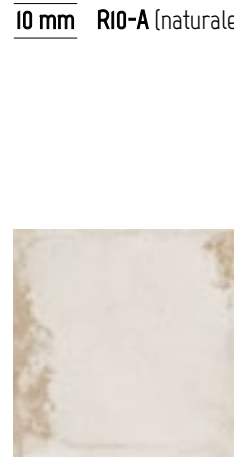

**089081**  
60x60 . 24"x24"  
Nat. Ret.  
**089082**  
60x60 . 24"x24"  
Lap. Ret.



**089101**  
30x60 . 12"x24"  
Nat. Ret.  
**089102**  
30x60 . 12"x24"  
Lap. Ret.



**089161**  
Mosaico  
30x30 . 12"x12"  
Nat. Ret.  
**089162**  
Mosaico  
30x30 . 12"x12"  
Lap. Ret.

10 mm RIO-A (naturale)

modular system

ELLISON

INDOOR

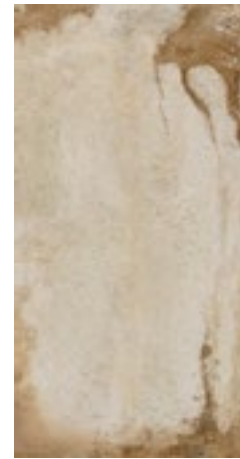

**089005**  
60x120 . 24"x48"  
Nat. Ret.  
**089006**  
60x120 . 24"x48"  
Lap. Ret.



**089025**  
30x120 . 12"x48"  
Nat. Ret.  
**089026**  
30x120 . 12"x48"  
Lap. Ret.



**089045**  
20x120 . 8"x48"  
Nat. Ret.  
**089046**  
20x120 . 8"x48"  
Lap. Ret.



**089085**  
60x60 . 24"x24"  
Nat. Ret.  
**089086**  
60x60 . 24"x24"  
Lap. Ret.



**089105**  
30x60 . 12"x24"  
Nat. Ret.  
**089106**  
30x60 . 12"x24"  
Lap. Ret.



**089165**  
Mosaico  
30x30 . 12"x12"  
Nat. Ret.  
**089166**  
Mosaico  
30x30 . 12"x12"  
Lap. Ret.

10 mm RIO-A (naturale)

modular system

Wall  
Mosaico Ellison 30x30 (12"x12") Nat. Ret.

Floor  
Ellison 60x120 (24"x48") Nat. Ret.



10 mm RIO-A (naturale)

ANSI A - 137.1: 2012  
WET DYNAMIC COEFFICIENT OF FRICTION  
Solo superficie naturale  
Only natural surface  
DCOF ≥ 0,42

	modular system												Mosaico Mosaic	Battiscopa Skirting	Gradino costa retta Straight-edge step **				Gradino costa retta - Angolo SX / DX Straight-edge step - LH/RH corner **				
	60x120 24"x48" Nat. Ret.	60x120 24"x48" Lap. Ret.	30x120 12"x48" Nat. Ret.	30x120 12"x48" Lap. Ret.	20x120 * 8"x48" Nat. Ret.	20x120 8"x48" Lap. Ret.	60x60 24"x24" Nat. Ret.	60x60 24"x24" Lap. Ret.	30x60 12"x24" Nat. Ret.	30x60 12"x24" Lap. Ret.	30x30 12"x12" Nat. Ret.	30x30 12"x12" Lap. Ret.		6,5x120 2 1/2"x48" Nat. Ret.	6,5x120 2 1/2"x48" Lap. Ret.	33x120x3,2h 13"x48"x1 1/4" Nat. Ret.	33x120x3,2h 13"x48"x1 1/4" Lap. Ret.	33x60x3,2h 13"x24"x1 1/4" Nat. Ret.	33x60x3,2h 13"x24"x1 1/4" Lap. Ret.	33x120x3,2h 13"x48"x1 1/4" Nat. Ret.	33x120x3,2h 13"x48"x1 1/4" Lap. Ret.	33x60x3,2h 13"x24"x1 1/4" Nat. Ret.	33x60x3,2h 13"x24"x1 1/4" Lap. Ret.
	089013	089014	089033	089034	089053	089054	089093	089094	089113	089114	089173	089174		089188	089189	089272	089273	089212	089213	089312 SX 089292 DX	089313 SX 089293 DX	089252 SX 089232 DX	089253 SX 089233 DX
KIMBERLY																							
NAXA																							
JEITA																							
CAPRI																							
ELLISON																							
PREZZO PRICE	€ 46,00 m <sup>2</sup>	€ 58,00 m <sup>2</sup>	€ 48,00 m <sup>2</sup>	€ 62,00 m <sup>2</sup>	€ 48,00 m <sup>2</sup>	€ 62,00 m <sup>2</sup>	€ 36,00 m <sup>2</sup>	€ 48,00 m <sup>2</sup>	€ 36,00 m <sup>2</sup>	€ 48,00 m <sup>2</sup>	€ 92,00 m <sup>2</sup>	€ 120,00 m <sup>2</sup>		€ 8,00 PZ/PCE	€ 9,00 PZ/PCE	€ 140,00 PZ/PCE	€ 148,00 PZ/PCE	€ 74,00 PZ/PCE	€ 76,00 PZ/PCE	€ 164,00 PZ/PCE	€ 176,00 PZ/PCE	€ 102,00 PZ/PCE	€ 106,00 PZ/PCE
CODICE PREZZO PRICE CODE	MI09	MI25	MI13	MI29	MI13	MI29	M089	MI13	M089	MI13	MI59	MI87		P029	P033	P207	P215	P141	P143	P231	P243	P169	P173
	Epal 80x120	Epal 80x120	Epal 80x120	Epal 80x120	Epal 80x120	Epal 80x120	Epal 80x120	Epal 80x120	Epal 80x120	Epal 80x120	Epal 80x120	Epal 80x120		Epal 80x120	Epal 80x120	Epal 80x120	Epal 80x120	Epal 80x120	Epal 80x120	Epal 80x120	Epal 80x120	Epal 80x120	Epal 80x120
IMBALLO cm h. PACKING cm h.	75	75	75	75	75	75	75	75	75	75	73			-	-	-	-	-	-	-	-	-	-
x	2	2	3	4	5	3	6	6	6	6	6			6	2	4	4	4	1	1	1	2	2
m <sup>2</sup> x	1,44	1,44	1,08	0,96	1,20	1,08	1,08	0,54	0,47	0,47	0,47			0,47	-	-	-	-	-	-	-	-	-
Kg x	31,46	31,46	24,08	22,27	26,50	24,08	24,08	13,23	10,55	10,55	13,23			10,55	23,00	20,00	20,00	20,00	13,00	13,00	11,00	11,00	11,00
x	32	30	40	48	42	40	40	40	54	54	54			-	-	-	-	-	-	-	-	-	-
m <sup>2</sup> x	46,08	46,08	43,20	46,08	50,40	43,20	43,20	29,16	-	-	29,16			-	-	-	-	-	-	-	-	-	-
Kg x	1.026	964	983	1.089	1.133	983	984	734	-	-	734			-	-	-	-	-	-	-	-	-	-

\*\* A DISPOSIZIONE SOLO SU RICHIESTA. TEMPI DI CONSEGNA: 30GG.

Available upon request only. Delivery terms: 30 days.  
Disponible seulement sur requête. Délais de livraison: 30 jours.  
Verfügbar auf Anfrage. Lieferzeit: 30 Tage.  
Disponibile sólo bajo pedido. Plazo de entrega: 30 días.  
Изготавливается только по специальной заявке. Срок поставки: 30 дней.

PER IL GRADINO NON SI GARANTISCE LA STESSA TONALITÀ DEL FONDO.

We cannot guarantee that the shade of the stair tile will be the same as the background tile.  
Pour la marche, nous ne garantissons pas la même tonalité du fond.  
Für die Stufe wird nicht der gleiche Farbton der Grundfliese garantiert.  
Para el peldaño no se garantiza el mismo tono del fondo.  
Для ступени не гарантирована одинаковость тона с фоном.

ATTENZIONE: Per un risultato ottimale si consiglia di utilizzare durante la posa i cunei.

ATTENTION: For a perfect result, we recommend you use wedges during laying.  
ATTENTION: Nous conseillons d'utiliser les coins durant la pose pour un résultat optimal.  
WARNUNG: Für ein ausgezeichnetes Ergebnis wird empfohlen, bei der Verlegung die Keile zu verwenden.  
ATENCIÓN: Para obtener un resultado optimizado se aconseja utilizar las cuñas durante la colocación.  
ВНИМАНИЕ: Для получения оптимального результата рекомендуется использовать клинья во время укладки.

ATTENZIONE: Si consiglia di mantenere una fuga di 3 mm per la posa in multiformato degli articoli rettificati.

ATTENTION: In the case of straightened-edge tiles, we recommend you keep a 3 mm joint when laying different-sized tiles together.  
ATTENTION: Il est recommandé de maintenir un joint de 3 mm pour la pose en multiformat des articles rectifiés.  
WARNUNG: Es wird geraten, eine Fuge von 3 mm bei der Verlegung der geschliffenen Artikel als Multiformat einzuhalten.  
ATENCIÓN: Se aconseja mantener una junta de 3 mm para la colocación en multiformato de los artículos rectificados.  
ВНИМАНИЕ: Рекомендуем оставлять шов 3 мм при укладке обрезной продукции нескольких форматов.



Floor: Petrol 60x60 (24"x24") Nat. Ret.

GRES PORCELLANATO COLORATO IN MASSA . COLORED BODY PORCELAIN STONEWARE  
GRES CÉRAMÉ COLORÉ DANS LA MASSE . EINGEFÄRBTES FEINSTEINZEUG  
GRES PORCELÁNICO COLOREADO EN MASA . КЕРАМОГРАНИТ ОКРАШЕННЫЙ В МАССЕ  
ISO 13006 - G - B1a (E ≤ 0,5%) - UNI EN 14411 - G

100% DESIGN  
AND PRODUCTION  
OF ITALY

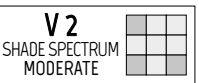

### INDOOR



**60x120** . 24"x48"  
Nat. Ret.  
**60x120** . 24"x48"  
Lap. Ret.



**60x60** . 24"x24"  
Nat. Ret.  
**60x60** . 24"x24"  
Lap. Ret.

10 mm

modular system

SVILUPPO GRAFICO PER FORMATO  
Pattern by size  
Développement graphique par format  
Grafischer Entwurf für Format  
Desarrollo gráfico por formato  
Варианты графики для каждого формата

**60x120**  
10 mm

16

**60x60**  
10 mm

32







Floor  
Beige 60x120 (24"x48") Lap. Ret.

Floor  
Light 60x60 (24"x24") Nat. Ret.

**DARK**

INDOOR



10 mm

**I47005**  
60x120 . 24"x48"  
Nat. Ret.

**I47015**  
60x120 . 24"x48"  
Lap. Ret.



**I47025**  
60x60 . 24"x24"  
Nat. Ret.

**I47035**  
60x60 . 24"x24"  
Lap. Ret.

— modular system —

**SKY**

INDOOR

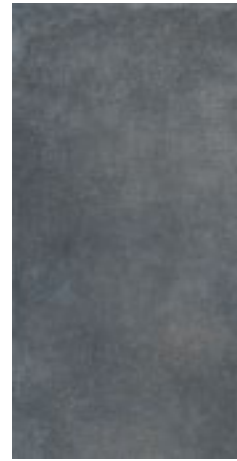

10 mm

**I47004**  
60x120 . 24"x48"  
Nat. Ret.

**I47014**  
60x120 . 24"x48"  
Lap. Ret.



**I47024**  
60x60 . 24"x24"  
Nat. Ret.

**I47034**  
60x60 . 24"x24"  
Lap. Ret.

— modular system —

**PETROL**

INDOOR



10 mm

**I47003**  
60x120 . 24"x48"  
Nat. Ret.

**I47013**  
60x120 . 24"x48"  
Lap. Ret.

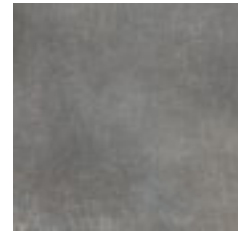

**I47023**  
60x60 . 24"x24"  
Nat. Ret.

**I47033**  
60x60 . 24"x24"  
Lap. Ret.

— modular system —

**LIGHT**

INDOOR



10 mm

**I47001**  
60x120 . 24"x48"  
Nat. Ret.

**I47011**  
60x120 . 24"x48"  
Lap. Ret.

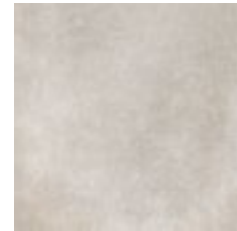

**I47021**  
60x60 . 24"x24"  
Nat. Ret.

**I47031**  
60x60 . 24"x24"  
Lap. Ret.

— modular system —

**BEIGE**

INDOOR

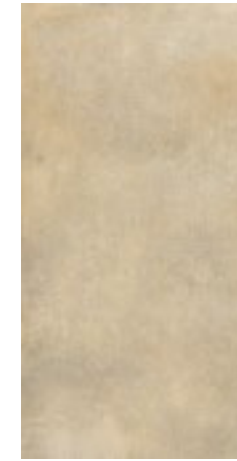

10 mm

**I47002**  
60x120 . 24"x48"  
Nat. Ret.

**I47012**  
60x120 . 24"x48"  
Lap. Ret.

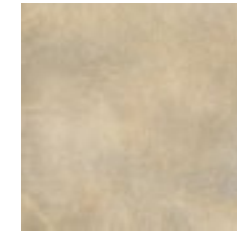

**I47022**  
60x60 . 24"x24"  
Nat. Ret.

**I47032**  
60x60 . 24"x24"  
Lap. Ret.

— modular system —

# RA-KU

10 mm

Solo superficie naturale  
Only natural surface

ANSI A - 137.1: 2012  
WET DYNAMIC COEFFICIENT OF FRICTION

DCOF ≥ 0,42

modular system				Battiscopa Skirting				Gradino costa retta Straight-edge step **		Gradino costa retta - Angolo SX / DX Straight-edge step - L/RH corner **		
	60x120 24"x48" Nat. Ret.	60x120 24"x48" Lap. Ret.	60x60 24"x24" Nat. Ret.	60x60 24"x24" Lap. Ret.	6,5x120 2 1/2"x48" Nat. Ret.	6,5x120 2 1/2"x48" Lap. Ret.	7x60 2 3/4"x24" Nat. Ret.	7x60 2 3/4"x24" Lap. Ret.	33x120x3,2h 13"x48"x1 1/4"h Nat. Ret.	33x60x3,2h 13"x24"x1 1/4"h Nat. Ret.	33x120x3,2h 13"x48"x1 1/4"h Nat. Ret.	33x60x3,2h 13"x24"x1 1/4"h Nat. Ret.
DARK	I47005	I47015	I47025	I47035	I47105	I47115	I47125	I47135	I47235	I47205	I47255 SX I47245 DX	I47225 SX I47215 DX
SKY	I47004	I47014	I47024	I47034	I47104	I47114	I47124	I47134	I47234	I47204	I47254 SX I47244 DX	I47224 SX I47214 DX
PETROL	I47003	I47013	I47023	I47033	I47103	I47113	I47123	I47133	I47233	I47203	I47253 SX I47243 DX	I47223 SX I47213 DX
LIGHT	I47001	I47011	I47021	I47031	I47101	I47111	I47121	I47131	I47231	I47201	I47251 SX I47241 DX	I47221 SX I47211 DX
BEIGE	I47002	I47012	I47022	I47032	I47102	I47112	I47122	I47132	I47232	I47202	I47252 SX I47242 DX	I47222 SX I47212 DX
PREZZO PRICE	€ 46,00 m <sup>2</sup>	€ 58,00 m <sup>2</sup>	€ 36,00 m <sup>2</sup>	€ 48,00 m <sup>2</sup>	€ 8,00 PZ/PCE	€ 9,00 PZ/PCE	€ 5,00 PZ/PCE	€ 6,00 PZ/PCE	€ 140,00 PZ/PCE	€ 74,00 PZ/PCE	€ 164,00 PZ/PCE	€ 102,00 PZ/PCE
CODICE PREZZO PRICE CODE	M109	M125	M089	M113	P029	P033	P017	P021	P207	P141	P231	P169
	<b>Epal</b> 80x120	<b>Epal</b> 80x120	<b>Epal</b> 80x120		<b>Epal</b> 80x120		<b>Epal</b> 80x120		<b>Epal</b> 80x120	<b>Epal</b> 80x120	<b>Epal</b> 80x120	<b>Epal</b> 80x120
IMBALLO cm h. PACKING cm h.	75	75	75		-		-		-	-	-	-
x	2	2	3		6		15		2	4	1	2
m <sup>2</sup> x	1,44	1,44	1,08		-		-		-	-	-	-
Kg x	32,40	33,12	24,09		11,04		14,70		23,00	23,00	12,00	12,00
x	30	30	40		-		-		-	-	-	-
m <sup>2</sup> x	43,20	43,20	43,20		-		-		-	-	-	-
Kg x	992	1.014	984		-		-		-	-	-	-



Floor  
Sky 60x120 (24"x48") Nat. Ret.

\*\* A DISPOSIZIONE SOLO SU RICHIESTA. TEMPI DI CONSEGNA: 30GG.  
Available upon request only. Delivery terms: 30 days.  
Disponible seulement sur requête. Délais de livraison: 30 jours.  
Verfügbar auf Anfrage. Lieferzeit: 30 Tage.  
Disponibile sólo bajo pedido. Plazo de entrega: 30 días.  
Изготавливается только по специальной заявке. Срок поставки: 30 дней.

PER IL GRADINO NON SI GARANTISCE LA STESSA TONALITÀ DEL FONDO.  
We cannot guarantee that the shade of the stair tile will be the same as the background tile.  
Pour la marche, nous ne garantissons pas la même tonalité du fond.  
Für die Stufe wird nicht der gleiche Farbton der Grundfliese garantiert.  
Para el peldaño no se garantiza el mismo tono del fondo.  
Для ступени не гарантирована одинаковость тона с фоном.



# RESINE

Floor: Grigio 80x80 (31 1/2"x31 1/2") Sat. Ret.

Grigio 30x60 . 12"x24" Nat. Ret.

GRES PORCELLANATO COLORATO IN MASSA . COLORED BODY PORCELAIN STONEWARE  
GRES CÉRAMÉ COLORÉ DANS LA MASSE . EINGEFÄRBTES FEINSTEINZEUG  
GRES PORCELÁNICO COLOREADO EN MASA . КЕРАМОГРАНИТ ОКРАШЕННЫЙ В МАССЕ  
ISO 13006 - G - B1a (E ≤ 0,5%) - UNI EN 14411 - G

100% DESIGN  
AND PRODUCTION  
OF ITALY

V2  
SHADE SPECTRUM  
MODERATE

## INDOOR

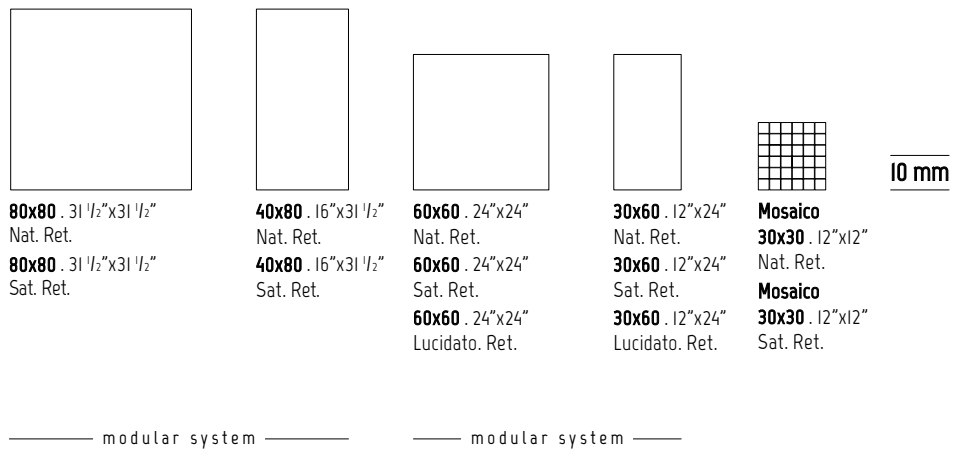

SVILUPPO GRAFICO PER FORMATO  
Pattern by size  
Développement graphique par format  
Grafischer Entwurf für Format  
Desarrollo gráfico por formato  
Варианты графики для каждого формата

80x80 10 mm	80x80 10 mm	80x80 10 mm	60x60 10 mm	40x80 10 mm	30x60 10 mm
20 Nero Tortora	18 Grigio	16 Bianco	20	40	40

# RESINE

10 mm



Floor  
Grigio 80x80 (31 1/2"x31 1/2") Sat. Ret.

# RESINE

## NERO

INDOOR



**093014**  
80x80 . 31 1/2"x31 1/2"  
Nat. Ret.

**093013**  
80x80 . 31 1/2"x31 1/2"  
Sat. Ret.



**093054**  
40x80 . 16"x31 1/2"  
Nat. Ret.

**093053**  
40x80 . 16"x31 1/2"  
Sat. Ret.



**093034**  
60x60 . 24"x24"  
Nat. Ret.

**093033**  
60x60 . 24"x24"  
Sat. Ret.

**093035**  
60x60 . 24"x24"  
Lucidato. Ret.



**093074**  
30x60 . 12"x24"  
Nat. Ret.

**093073**  
30x60 . 12"x24"  
Sat. Ret.

**093075**  
30x60 . 12"x24"  
Lucidato. Ret.

10 mm

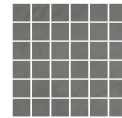

**093094**  
Mosaico  
30x30 . 12"x12"  
Nat. Ret.

**093093**  
Mosaico  
30x30 . 12"x12"  
Sat. Ret.

modular system

modular system

## GRIGIO

INDOOR



**093006**  
80x80 . 31 1/2"x31 1/2"  
Nat. Ret.

**093005**  
80x80 . 31 1/2"x31 1/2"  
Sat. Ret.



**093046**  
40x80 . 16"x31 1/2"  
Nat. Ret.

**093045**  
40x80 . 16"x31 1/2"  
Sat. Ret.



**093026**  
60x60 . 24"x24"  
Nat. Ret.

**093025**  
60x60 . 24"x24"  
Sat. Ret.

**093027**  
60x60 . 24"x24"  
Lucidato. Ret.

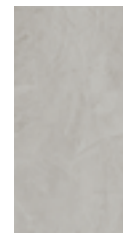

**093066**  
30x60 . 12"x24"  
Nat. Ret.

**093065**  
30x60 . 12"x24"  
Sat. Ret.

**093067**  
30x60 . 12"x24"  
Lucidato. Ret.

10 mm

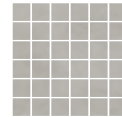

**093086**  
Mosaico  
30x30 . 12"x12"  
Nat. Ret.

**093085**  
Mosaico  
30x30 . 12"x12"  
Sat. Ret.

modular system

modular system

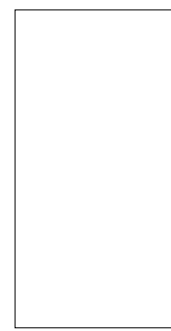

320x160 . 126"x63"



160x160 . 63"x63"

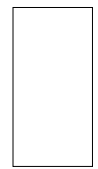

160x80 . 63"x31 1/2"



80x80 . 31 1/2"x31 1/2"

6 mm

modular system



240x120 . 96"x48"



120x120 . 48"x48"

6 mm

modular system

## BIANCO

INDOOR

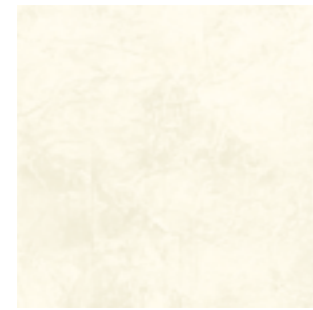

**093002**  
80x80 . 31 1/2"x31 1/2"  
Nat. Ret.

**093001**  
80x80 . 31 1/2"x31 1/2"  
Sat. Ret.



**093042**  
40x80 . 16"x31 1/2"  
Nat. Ret.

**093041**  
40x80 . 16"x31 1/2"  
Sat. Ret.



**093022**  
60x60 . 24"x24"  
Nat. Ret.

**093021**  
60x60 . 24"x24"  
Sat. Ret.

**093023**  
60x60 . 24"x24"  
Lucidato. Ret.



**093062**  
30x60 . 12"x24"  
Nat. Ret.

**093061**  
30x60 . 12"x24"  
Sat. Ret.

**093063**  
30x60 . 12"x24"  
Lucidato. Ret.

10 mm



**093082**  
Mosaico  
30x30 . 12"x12"  
Nat. Ret.

**093081**  
Mosaico  
30x30 . 12"x12"  
Sat. Ret.

modular system

modular system

## TORTORA

INDOOR



**093010**  
80x80 . 31 1/2"x31 1/2"  
Nat. Ret.

**093009**  
80x80 . 31 1/2"x31 1/2"  
Sat. Ret.



**093050**  
40x80 . 16"x31 1/2"  
Nat. Ret.

**093049**  
40x80 . 16"x31 1/2"  
Sat. Ret.



**093030**  
60x60 . 24"x24"  
Nat. Ret.

**093029**  
60x60 . 24"x24"  
Sat. Ret.

**093031**  
60x60 . 24"x24"  
Lucidato. Ret.



**093070**  
30x60 . 12"x24"  
Nat. Ret.

**093069**  
30x60 . 12"x24"  
Sat. Ret.

**093071**  
30x60 . 12"x24"  
Lucidato. Ret.

10 mm

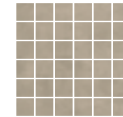

**093090**  
Mosaico  
30x30 . 12"x12"  
Nat. Ret.

**093089**  
Mosaico  
30x30 . 12"x12"  
Sat. Ret.

modular system

modular system

LA SERIE RESINE SI COMPLETA CON LE GRANDI LASTRE DEL CATALOGO AVA - SERIE DISTRICT

The Resine series is completed with the large slabs which can be seen in the AVA - series District  
La série Resine est complétée par les grandes dalles du catalogue AVA - série District  
Die Serie Resine wird durch die großen Platten des Katalogs AVA - Serie District  
La serie Resine se completa con las grandes planchas del catálogo AVA - serie District  
Серия Resine дополняется большими плитами из каталога Ava - Серия District

I VETTORIALI DELLE GRANDI LASTRE NON SONO IN SCALA CON QUELLI DI LA FABBRICA

The vector images of the large slabs are not in scale with the La Fabbrica images.  
Les vecteurs des grandes dalles ne sont pas à l'échelle avec ceux de La Fabbrica.  
Die Vektorbilder der großen Platten sind nicht maßstabsgetreu zu denen von La Fabbrica.  
Los vectoriales de las grandes planchas no están a escala con aquellos de La Fabbrica.  
Масштаб векторных изображений больших плит не совпадает с масштабом векторных изображений La Fabbrica.

# RESINE

10 mm

Solo superficie naturale  
Only natural surface

ANSI A - 137.1: 2012  
WET DYNAMIC COEFFICIENT OF FRICTION

DCOF ≥ 0,42

	modular system				modular system						Mosaico Mosaic		Battiscopa Skirting		Gradino costa retta Straight-edge step **						Gradino costa retta - Angolo SX / DX Straight-edge step - LH/RH corner **										
	80x80 31 1/2"x31 1/2" Nat. Ret.	80x80 31 1/2"x31 1/2" Sat. Ret.	40x80 16"x31 1/2" Nat. Ret.	40x80 16"x31 1/2" Sat. Ret.	60x60 24"x24" Nat. Ret.	60x60 24"x24" Sat. Ret.	60x60 24"x24" Lucidato. Ret.	30x60 12"x24" Nat. Ret.	30x60 12"x24" Sat. Ret.	30x60 12"x24" Lucidato. Ret.	30x30 12"x12" Nat. Ret.	30x30 12"x12" Sat. Ret.	8x80 3"x31 1/2" Nat. Ret.	8x80 3"x31 1/2" Sat. Ret.	9,5x60 3 3/4"x24" Nat. Ret.	9,5x60 3 3/4"x24" Sat. Ret.	9,5x60 3 3/4"x24" Lucidato. Ret.	33x80x3,2h 13"x31 1/2"x1 1/4" Nat. Ret.	33x80x3,2h 13"x31 1/2"x1 1/4" Sat. Ret.	33x60x3,2h 13"x24"x1 1/4" Nat. Ret.	33x60x3,2h 13"x24"x1 1/4" Sat. Ret.	33x60x3,2h 13"x24"x1 1/4" Lucidato. Ret.	33x80x3,2h 13"x31 1/2"x1 1/4" Nat. Ret.	33x80x3,2h 13"x31 1/2"x1 1/4" Sat. Ret.	33x60x3,2h 13"x24"x1 1/4" Nat. Ret.	33x60x3,2h 13"x24"x1 1/4" Sat. Ret.	33x60x3,2h 13"x24"x1 1/4" Lucidato. Ret.	993184 SX 993164 DX	993183 SX 993163 DX	993234 SX 993214 DX	993233 SX 993213 DX
NERO	093014	093013	093054	093053	093034	093033	093035	093074	093073	093075	093094	093093	093104	093103	093124	093123	093125	093144	093143	093194	093193	093324	093184 SX 993164 DX	093183 SX 993163 DX	093234 SX 993214 DX	093233 SX 993213 DX	093336 SX 993335 DX				
GRIGIO	093006	093005	093046	093045	093026	093025	093027	093066	093065	093067	093086	093085	093100	093099	093120	093119	093121	093140	093139	093190	093189	093323	093180 SX 993160 DX	093179 SX 993159 DX	093230 SX 993210 DX	093229 SX 993209 DX	093333 SX 993332 DX				
BIANCO	093002	093001	093042	093041	093022	093021	093023	093062	093061	093063	093082	093081	093092	093091	093112	093111	093113	093132	093131	093182	093181	093321	093172 SX 993152 DX	093171 SX 993151 DX	093222 SX 993202 DX	093221 SX 993201 DX	093328 SX 993327 DX				
TORTORA	093010	093009	093050	093049	093030	093029	093031	093070	093069	093071	093090	093089	093096	093095	093116	093115	093117	093136	093135	093186	093185	093322	093176 SX 993156 DX	093175 SX 993155 DX	093226 SX 993206 DX	093225 SX 993205 DX	093331 SX 993330 DX				
PREZZO PRICE	€ 46,00 m <sup>2</sup>	€ 52,00 m <sup>2</sup>	€ 46,00 m <sup>2</sup>	€ 52,00 m <sup>2</sup>	€ 36,00 m <sup>2</sup>	€ 44,00 m <sup>2</sup>	€ 52,00 m <sup>2</sup>	€ 36,00 m <sup>2</sup>	€ 44,00 m <sup>2</sup>	€ 52,00 m <sup>2</sup>	€ 92,00 m <sup>2</sup>	€ 6,00 PZ/PCE	€ 5,00 PZ/PCE	€ 6,00 PZ/PCE	€ 100,00 PZ/PCE	€ 74,00 PZ/PCE	€ 76,00 PZ/PCE	€ 112,00 PZ/PCE	€ 102,00 PZ/PCE	€ 106,00 PZ/PCE	€ 106,00 PZ/PCE	€ 112,00 PZ/PCE	€ 102,00 PZ/PCE	€ 102,00 PZ/PCE	€ 102,00 PZ/PCE	€ 106,00 PZ/PCE					
CODICE PREZZO PRICE CODE	MI09	MI19	MI09	MI19	MO89	MI05	MI19	MO89	MI05	MI19	MI59	PO21	PO17	PO21	PI67	PI41	PI43	PI79	PI69	PI73											
IMBALLO cm h. PACKING cm h.	95	95	95	95	75	75	75	75	75	75	75	-	-	-	-	-	-	-	-	-	-	-	-	-	-	-	-				
x	2	3	6	3	6	6	6	10	12	2	4	1	2																		
m <sup>2</sup> x	1,28	0,96	1,08	1,08	0,54	-	-	-	-	-	-	-	-																		
Kg x	30,14	22,27	24,84	24,95	24,84	11,50	15	14,52	16,00	24,00	8,50	12,50																			
x	40	56	40	40	40	54	-	-	-	-	-	-																			
m <sup>2</sup> x	51,20	53,76	43,20	43,20	43,20	29,16	-	-	-	-	-	-																			
Kg x	1.226	1.267	1.014	1.018	1.014	641	-	-	-	-	-	-																			

\*\* A DISPOSIZIONE SOLO SU RICHIESTA. TEMPI DI CONSEGNA: 30GG.  
Available upon request only. Delivery terms: 30 days.  
Disponible seulement sur requête. Délais de livraison: 30 jours.  
Verfügbar auf Anfrage. Lieferzeit: 30 Tage.  
Disponibile sólo bajo pedido. Plazo de entrega: 30 días.  
Изготавливается только по специальной заявке. Срок поставки: 30 дней.

PER IL GRADINO NON SI GARANTISCE LA STESSA TONALITÀ DEL FONDO.  
We cannot guarantee that the shade of the stair tile will be the same as the background tile.  
Pour la marche, nous ne garantissons pas la même tonalité du fond.  
Für die Stufe wird nicht der gleiche Farbton der Grundfliese garantiert.  
Para el peldaño no se garantiza el mismo tono del fondo.  
Для ступени не гарантирована одинаковость тона с фоном.





# SPACE

Wall: Cement 20x20 (6"x6") Nat. - Cement Pattern 20x20 (6"x6") Nat. / Floor: Cement 60x20 (24"x48") Nat. Ret.

GRES PORCELLANATO COLORATO IN MASSA . COLORED BODY PORCELAIN STONEWARE  
GRÈS CÉRAME COLORÉ DANS LA MASSE . EINGEFÄRBTES FEINSTEINZEUG  
GRES PORCELÁNICO COLOREADO EN MASA . КЕРАМОГРАНИТ ОКРАШЕННЫЙ В МАССЕ  
ISO 13006 - G - BIa (E ≤ 0,5%) - UNI EN 14411 - G

100% DESIGN  
AND PRODUCTION  
OF ITALY

V2  
SHADE SPECTRUM  
MODERATE

## INDOOR

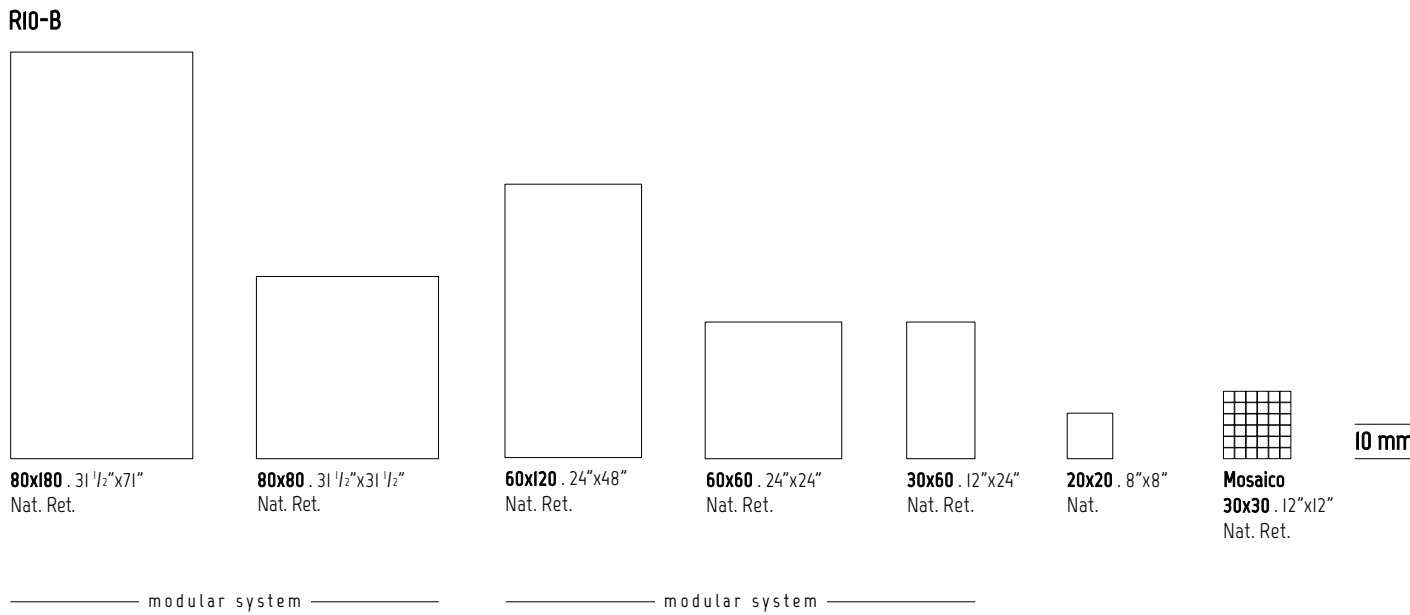

## OUTDOOR

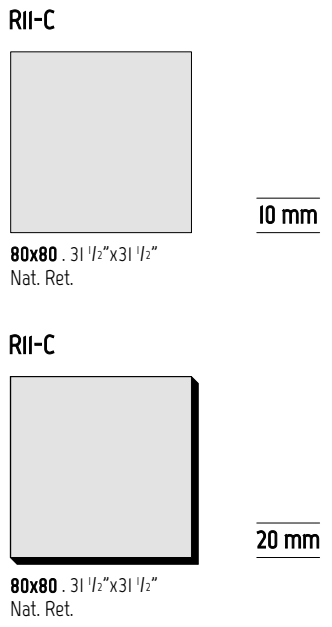

SVILUPPO GRAFICO PER FORMATO Pattern by size Développement graphique par format Grafischer Entwurf für Format Desarrollo gráfico por formato Варианты графики для каждого формата	80x180 10 mm	60x120 10 mm	80x80 10 mm	60x60 10 mm	30x60 10 mm	20x20 10 mm	80x80 20 mm
	12	24	25	46	92	10	25

# SPACE

10 mm RI0-B



INDOOR  
Floor  
Cement 80x80 (31 1/2"x31 1/2") Nat. Ret.

OUTDOOR  
Floor  
Cement 80x80 (31 1/2"x31 1/2") Nat. Ret. R11  
Cement 80x80 (31 1/2"x31 1/2") Nat. Ret. R11 20mm

# SPACE

## BONE

INDOOR



10 mm R10-B

10 mm R10-B

modular system

modular system

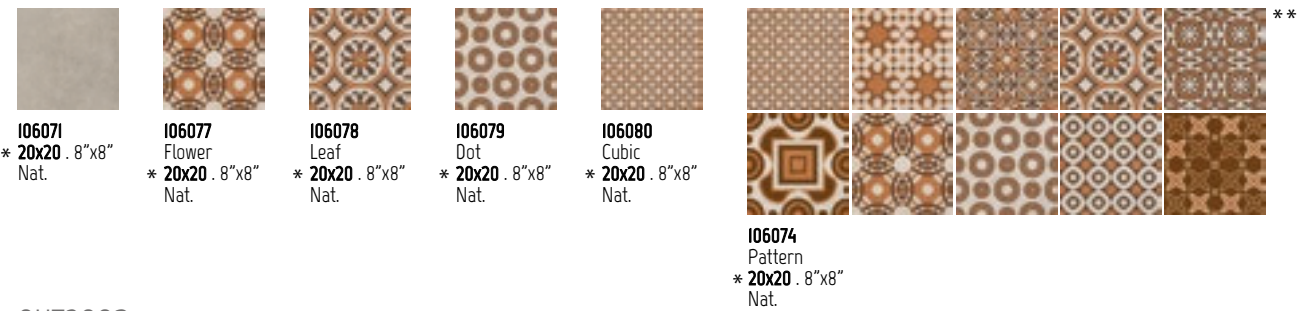

106071  
\* 20x20 . 8"x8"  
Nat.

106077  
Flower  
\* 20x20 . 8"x8"  
Nat.

106078  
Leaf  
\* 20x20 . 8"x8"  
Nat.

106079  
Dot  
\* 20x20 . 8"x8"  
Nat.

106080  
Cubic  
\* 20x20 . 8"x8"  
Nat.

106074  
Pattern  
\* 20x20 . 8"x8"  
Nat.

## OUTDOOR



10 mm R11-C

20 mm R11-C

106011  
80x80 . 31 1/2" x 31 1/2"  
Nat. Ret.

106016  
80x80 . 31 1/2" x 31 1/2"  
Nat. Ret.

\* QUESTO FORMATO NON È MODULARE ED ABBINABILE AGLI ALTRI FORMATI IN GAMMA

This size is not modular and cannot be used together with the other sizes in the range.  
Ce format n'est pas modulaire et il ne peut être associé aux autres formats de la gamme.  
Dieses Format ist nicht modular und lässt sich mit anderen Formaten der Serie kombinieren.  
Este formato no es modular ni puede ser combinado con otros formatos de la gama.  
Этот формат не является модульным и не сочетается с другими имеющимися в ассортименте форматами.

## CEMENT

INDOOR

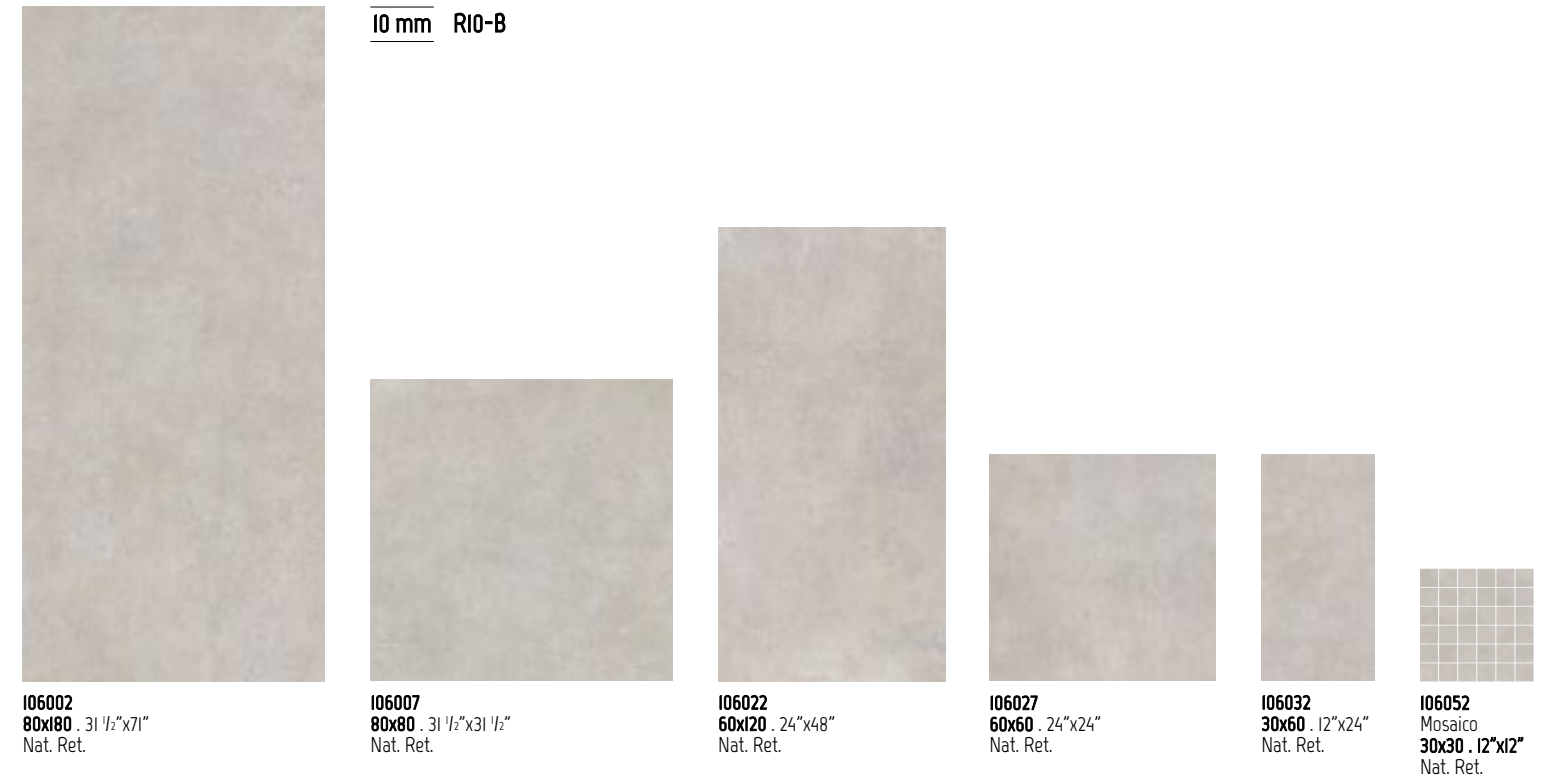

10 mm R10-B

modular system

modular system



106072  
\* 20x20 . 8"x8"  
Nat.

106083  
Flower  
\* 20x20 . 8"x8"  
Nat.

106081  
Leaf  
\* 20x20 . 8"x8"  
Nat.

106084  
Spot  
\* 20x20 . 8"x8"  
Nat.

106082  
Imperial  
\* 20x20 . 8"x8"  
Nat.

106075  
Pattern  
\* 20x20 . 8"x8"  
Nat.

## OUTDOOR



10 mm R11-C

20 mm R11-C

106012  
80x80 . 31 1/2" x 31 1/2"  
Nat. Ret.

106017  
80x80 . 31 1/2" x 31 1/2"  
Nat. Ret.

\*\*IN OGNI SCATOLA LA COMBINAZIONE DEI SOGGETTI È DEL TUTTO CASUALE. LO STESSO SOGGETTO POTREBBE ESSERE RIPETUTO OPPURE POTREBBE NON ESSERE PRESENTE NELLA SCATOLA.

Each box contains a random assortment of the designs available. The same design may be repeated and certain designs may not be included in the box.  
La combinaison des motifs à l'intérieur de chaque boîte est absolument fortuite. Le même motif pourrait être répété ou ne pas se trouver à l'intérieur de la boîte.  
Die Zusammenstellung der Motive ist in jedem Karton vollkommen zufällig. Das selbe Motiv könnte sich wiederholen oder nicht im Karton vorhanden sein.  
En cada caja la combinación de los temas es del todo casual. En una caja un tema puede estar repetido o estar ausente.  
Сочетание мотивов в каждой коробке является совершенно случайным. Один и тот же мотив может присутствовать в коробке несколько раз или, наоборот, отсутствовать.

# SPACE

## PLOMB

INDOOR

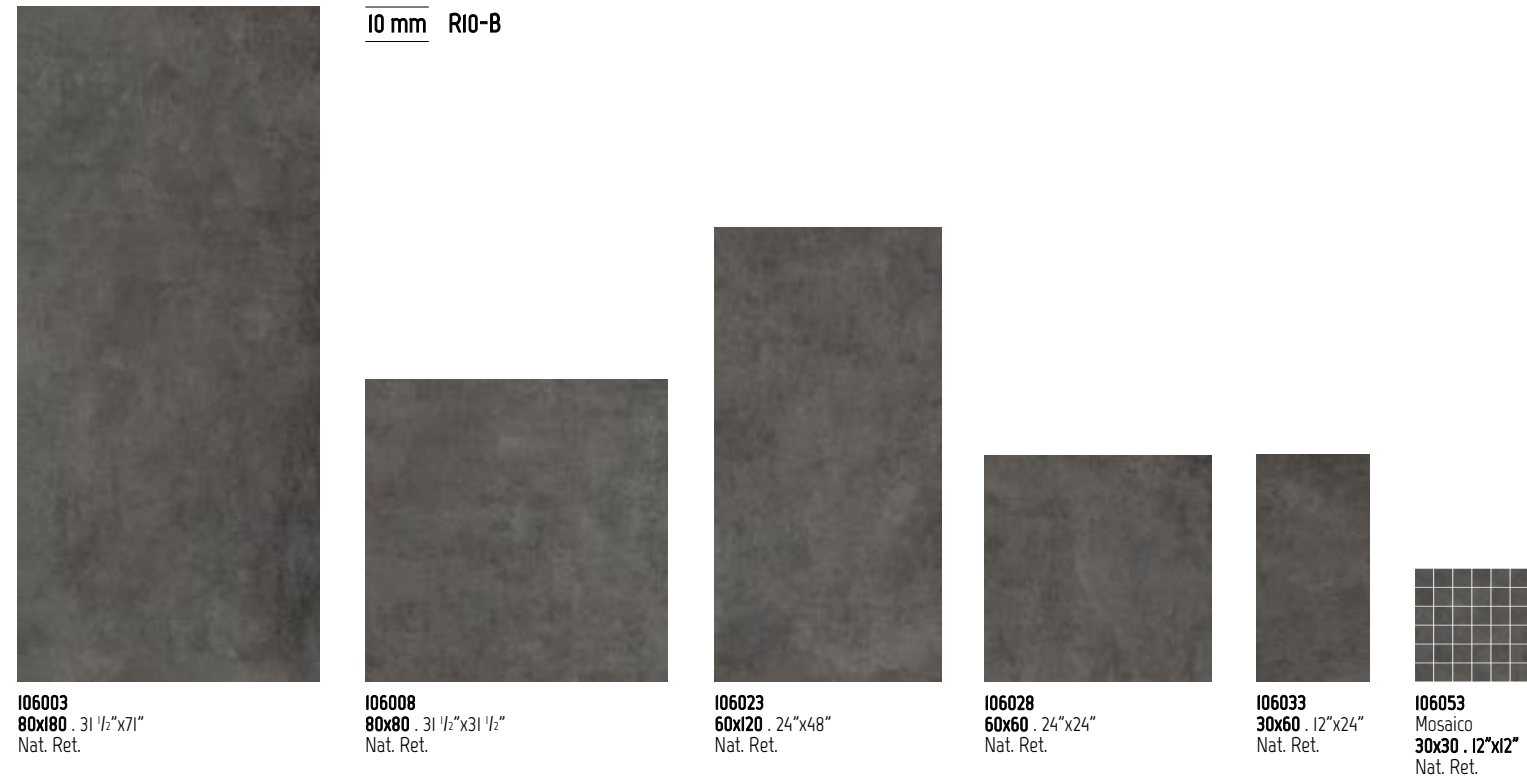

modular system

modular system

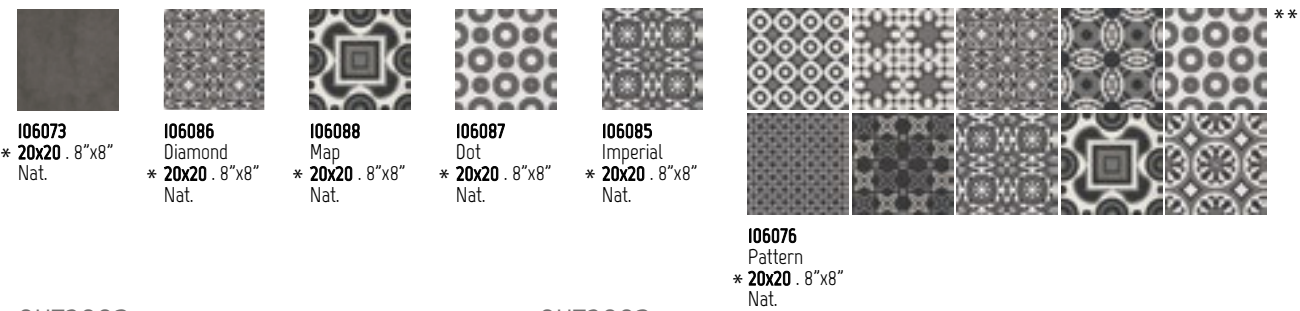

OUTDOOR

OUTDOOR

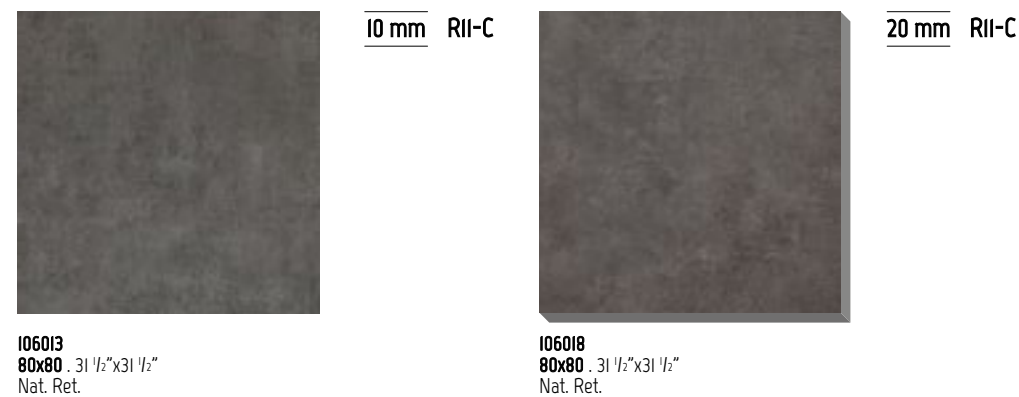

**\* QUESTO FORMATO NON È MODULARE ED ABBINABILE AGLI ALTRI FORMATI IN GAMMA**  
 This size is not modular and cannot be used together with the other sizes in the range.  
 Ce format n'est pas modulaire et il ne peut être associé aux autres formats de la gamme.  
 Dieses Format ist nicht modular und lässt sich mit anderen Formaten der Serie kombinieren.  
 Este formato no es modular ni puede ser combinado con otros formatos de la gama.  
 Этот формат не является модульным и не сочетается с другими имеющимися в ассортименте форматами.



Wall  
 Plomb Diamond 20x20 (8"x8") Nat. - Plomb Dot 20x20 (8"x8") Nat.  
 Plomb Imperial 20x20 (8"x8") Nat. - Plomb Map 20x20 (8"x8") Nat. - Plomb 20x20 - (8"x8") Nat.  
 Bone 30x60 (12"x24") Nat. Ret.

Floor  
 Bone 60x60 (24"x24") Nat. Ret.

**\*\*IN OGNI SCATOLA LA COMBINAZIONE DEI SOGGETTI È DEL TUTTO CASUALE. LO STESSO SOGGETTO POTREBBE ESSERE RIPETUTO OPPURE POTREBBE NON ESSERE PRESENTE NELLA SCATOLA.**  
 Each box contains a random assortment of the designs available. The same design may be repeated and certain designs may not be included in the box.  
 La combinaison des motifs à l'intérieur de chaque boîte est absolument fortuite. Le même motif pourrait être répété ou ne pas se trouver à l'intérieur de la boîte.  
 Die Zusammenstellung der Motive ist in jedem Karton vollkommen zufällig. Das selbe Motiv könnte sich wiederholen oder nicht im Karton vorhanden sein.  
 En cada caja la combinación de los temas es del todo casual. En una caja un tema puede estar repetido o estar ausente.  
 Сочетание мотивов в каждой коробке является совершенно случайным. Один и тот же мотив может присутствовать в коробке несколько раз или, наоборот, отсутствовать.

# SPACE

10 mm RIO-B

ANSI A - 137.1: 2012  
WET DYNAMIC COEFFICIENT OF FRICTION  
DCOF ≥ 0,42

	modular system					modular system					Decoro Flower Flower decorative tile	Decoro Leaf Leaf decorative tile	Decoro Dot Dot decorative tile	Decoro Cubic Cubic decorative tile	Decoro Imperial Imperial decorative tile	Decoro Spot Spot decorative tile	Decoro Diamond Diamond decorative tile	Decoro Map Map decorative tile	Decoro Pattern Pattern decorative tile	Mosaico Mosaic	Battiscopa Skirting	Gradino costa retta Straight-edge step **	Gradino costa retta - Angolo SX / DX Straight-edge step - L/R corner **				
	80x180 31 1/2"x71" Nat. Ret.	80x80 31 1/2"x31 1/2" Nat. Ret.	60x120 24"x48" Nat. Ret.	60x60 24"x24" Nat. Ret.	30x60 12"x24" Nat. Ret.	20x20 8"x8" Nat.	20x20 8"x8" Nat.	20x20 8"x8" Nat.	20x20 8"x8" Nat.	20x20 8"x8" Nat.	20x20 8"x8" Nat.	20x20 8"x8" Nat.	20x20 8"x8" Nat.	20x20 8"x8" Nat.	20x20 8"x8" Nat.	20x20 8"x8" Nat.	20x20 8"x8" Nat.	20x20 8"x8" Nat.	30x30 12"x12" Nat. Ret.	6,5x120 2 1/2"x48" Nat. Ret.	7x60 3"x24" Nat. Ret.	33x120x3,2h 13"x48"x1 1/4" Nat. Ret.	33x80x3,2h 13"x31 1/2"x1 1/4" Nat. Ret.	33x60x3,2h 13"x24"x1 1/4" Nat. Ret.	33x120x3,2h 13"x48"x1 1/4" Nat. Ret.	33x80x3,2h 13"x31 1/2"x1 1/4" Nat. Ret.	33x60x3,2h 13"x24"x1 1/4" Nat. Ret.
PLOMB	106003	106008	106023	106028	106033	106073	-	-	106087	-	106085	-	106086	106088	106076	106053	106063	106068	106107	106127	106206	106109 SX 106108 DX	106129 SX 106128 DX	106208 SX 106207 DX			
CEMENT	106002	106007	106022	106027	106032	106072	106083	106081	-	-	106082	106084	-	-	106075	106052	106062	106067	106104	106124	106203	106106 SX 106105 DX	106126 SX 106125 DX	106205 SX 106204 DX			
BONE	106001	106006	106021	106026	106031	106071	106077	106078	106079	106080	-	-	-	-	106074	106051	106061	106066	106101	106121	106200	106103 SX 106102 DX	106123 SX 106122 DX	106202 SX 106201 DX			
PREZZO PRICE	€ 58,00 m <sup>2</sup>	€ 36,00 m <sup>2</sup>	€ 40,00 m <sup>2</sup>	€ 33,00 m <sup>2</sup>	€ 32,00 m <sup>2</sup>	€ 29,00 m <sup>2</sup>	€ 32,00 m <sup>2</sup>	€ 32,00 m <sup>2</sup>	€ 32,00 m <sup>2</sup>	€ 32,00 m <sup>2</sup>	€ 32,00 m <sup>2</sup>	€ 32,00 m <sup>2</sup>	€ 32,00 m <sup>2</sup>	€ 32,00 m <sup>2</sup>	€ 32,00 m <sup>2</sup>	€ 32,00 m <sup>2</sup>	€ 32,00 m <sup>2</sup>	€ 32,00 m <sup>2</sup>	€ 68,00 m <sup>2</sup>	€ 8,00 PZ/PCE	€ 5,00 PZ/PCE	€ 140,00 PZ/PCE	€ 100,00 PZ/PCE	€ 68,00 PZ/PCE	€ 152,00 PZ/PCE	€ 112,00 PZ/PCE	€ 84,00 PZ/PCE
CODICE PREZZO PRICE CODE	M125	M089	M097	M083	M081	M075	M081	M081	M081	M081	M081	M081	M081	M081	M081	M081	M081	M081	M135	P029	P017	P207	P167	P135	P219	P179	P151
	Pallet con sponde 97x188	Epal 80x120	Epal 80x120	Epal 80x120	Epal 80x120	Pallet 80x120	Pallet 80x120	Pallet 80x120	Pallet 80x120	Pallet 80x120	Pallet 80x120	Pallet 80x120	Pallet 80x120	Pallet 80x120	Pallet 80x120	Pallet 80x120	Pallet 80x120	Pallet 80x120	Epal 80x120	Epal 80x120	Epal 80x120	Epal 80x120	Epal 80x120	Epal 80x120	Epal 80x120	Epal 80x120	Epal 80x120
IMBALLO cm h. PACKING cm h.	70	95	75	75	75	75	75	75	75	75	75	75	75	75	75	75	75	75	75	55	50	-	-	-	-	-	-
x	2	2	2	3	6	30	30	30	30	30	30	30	30	30	30	30	30	30	6	6	15	2	2	4	1	1	2
m <sup>2</sup> x	2,88	1,28	1,44	1,08	1,08	1,20	1,20	1,20	1,20	1,20	1,20	1,20	1,20	1,20	1,20	1,20	1,20	1,20	0,54	0,47	0,63	-	-	-	-	-	-
Kg x	69,12	30,14	32,68	25,38	25,38	23,04	23,04	23,04	23,04	23,04	23,04	23,04	23,04	23,04	23,04	23,04	23,04	23,04	13,00	10,55	14,76	23,00	16,00	23,00	12,00	8,50	12,00
x	20	40	32	40	40	60	60	60	60	60	60	60	60	60	60	60	60	60	54	45	56	-	-	-	-	-	-
m <sup>2</sup> x	57,60	51,20	46,08	43,20	43,20	72	72	72	72	72	72	72	72	72	72	72	72	72	29,16	21,15	35,28	-	-	-	-	-	-
Kg x	1.412	1.226	1.066	1.035	1.035	1.397	1.397	1.397	1.397	1.397	1.397	1.397	1.397	1.397	1.397	1.397	1.397	1.397	722	495	846	-	-	-	-	-	-

\*\* A DISPOSIZIONE SOLO SU RICHIESTA. TEMPI DI CONSEGNA: 30GG.

Available upon request only. Delivery terms: 30 days.  
Disponible seulement sur requête. Délais de livraison: 30 jours.  
Verfügbar auf Anfrage. Lieferzeit: 30 Tage.  
Disponibile sólo bajo pedido. Plazo de entrega: 30 días.  
Изготавливается только по специальной заявке. Срок поставки: 30 дней.

PER IL GRADINO NON SI GARANTISCE LA STESSA TONALITÀ DEL FONDO.

We cannot guarantee that the shade of the stair tile will be the same as the background tile.  
Pour la marche, nous ne garantissons pas la même tonalité du fond.  
Für die Stufe wird nicht der gleiche Farbton der Grundfliese garantiert.  
Para el peldaño no se garantiza el mismo tono del fondo.  
Для ступени не гарантирована одинаковость тона с фоном.

\* IN OGNI SCATOLA LA COMBINAZIONE DEI SOGGETTI È DEL TUTTO CASUALE. LO STESSO SOGGETTO POTREBBE ESSERE RIPETUTO OPPURE POTREBBE NON ESSERE PRESENTE NELLA SCATOLA.

Each box contains a random assortment of the designs available. The same design may be repeated and certain designs may not be included in the box.  
La combinaison des motifs à l'intérieur de chaque boîte est absolument fortuite. Le même motif pourrait être répété ou ne pas se trouver à l'intérieur de la boîte.  
Die Zusammenstellung der Motive ist in jedem Karton vollkommen zufällig. Das selbe Motiv könnte sich wiederholen oder nicht im Karton vorhanden sein.  
En cada caja la combinación de los temas es del todo casual. En una caja un tema puede estar repetido o estar ausente.  
Сочетание мотивов в каждой коробке является совершенно случайным. Один и тот же мотив может присутствовать в коробке несколько раз или, наоборот, отсутствовать.

# SPACE

10 mm RII-B    20 mm RII-C

ANSI A - I37.1: 2012  
WET DYNAMIC COEFFICIENT OF FRICTION | COF ≥ 0,42

	80x80 31 1/2" x 31 1/2" Nat. Ret. 10 mm RII	80x80 31 1/2" x 31 1/2" Nat. Ret. 20 mm RII	Griglia 20 Drainage grid 20 20x80 8" x 31 1/2"	Griglia 20 - Angolo SX / DX Drainage grid 20 - Corner SX / DX 20x80 8" x 31 1/2"	Gradone bordo grip Large step with anti-slip border 40x80 16" x 31 1/2"	Gradone bordo grip - Angolo SX / DX Large step with anti-slip border Corner SX / DX 40x80 16" x 31 1/2"	Gradone bordo 40 Large step 40 40x80 16" x 31 1/2"	Gradone bordo 40 SX / DX Large step 40 - Corner SX / DX 40x80 16" x 31 1/2"	Gradone bordo svasato Large step with rounded border 40x80 16" x 31 1/2"	Gradone bordo svasato - Angolo SX / DX Large step with rounded border - Corner SX / DX 40x80 16" x 31 1/2"						
PLOMB	106013	106018	106398	106404 SX 106401 DX	106353	106344	106356 DX 106359 SX	106347 DX 106350 SX	106389	106380	106395 SX 106392 DX	106386 SX 106383 DX	106371	106362	106377 SX 106374 DX	106368 SX 106365 DX
CEMENT	106012	106017	106397	106403 SX 106400 DX	106352	106343	106355 DX 106358 SX	106346 DX 106349 SX	106388	106379	106394 SX 106391 DX	106385 SX 106382 DX	106370	106361	106376 SX 106373 DX	106367 SX 106364 DX
BONE	106011	106016	106396	106402 SX 106399 DX	106351	106342	106354 DX 106357 SX	106345 DX 106348 SX	106387	106378	106393 SX 106390 DX	106384 SX 106381 DX	106369	106360	106375 SX 106372 DX	106366 SX 106363 DX
PREZZO PRICE	€ 36,00 m <sup>2</sup>	€ 70,00 m <sup>2</sup>	€ 172,00 PZ/PCE	€ 172,00 PZ/PCE	€ 104,00 PZ/PCE	€ 92,00 PZ/PCE	€ 122,00 PZ/PCE	€ 110,00 PZ/PCE	€ 88,00 PZ/PCE	€ 76,00 PZ/PCE	€ 106,00 PZ/PCE	€ 94,00 PZ/PCE	€ 190,00 PZ/PCE	€ 168,00 PZ/PCE	€ 208,00 PZ/PCE	€ 186,00 PZ/PCE
CODICE PREZZO PRICE CODE	M089	M137	P239	P239	P171	P159	P189	P177	P155	P143	P173	P161	P257	P235	P271	P253
	Epal 80x120	Epal 80x120	Epal 80x120	Epal 80x120	Epal 80x120	Epal 80x120	Epal 80x120	Epal 80x120	Epal 80x120	Epal 80x120	Epal 80x120	Epal 80x120	Epal 80x120	Epal 80x120	Epal 80x120	Epal 80x120
IMBALLO cm h. PACKING cm h.	95	95	-	-	-	-	-	-	-	-	-	-	-	-	-	-
x	2	1	1	1	1	1	1	1	1	1	1	1	1	1	1	1
m <sup>2</sup> x	1,28	0,64	-	-	-	-	-	-	-	-	-	-	-	-	-	-
Kg x	30,14	27,78	8,00	7,5	12,50	12,50	12,50	12,50	12,50	12,50	12,50	12,50	12,50	12,50	12,50	12,50
x	40	40	-	-	-	-	-	-	-	-	-	-	-	-	-	-
m <sup>2</sup> x	51,20	25,60	-	-	-	-	-	-	-	-	-	-	-	-	-	-
Kg x	1.226	1.130	-	-	-	-	-	-	-	-	-	-	-	-	-	-

### TRA I FONDI DI SPESSORE 10 E 20 MM NON SI GARANTISCE L'ABBINABILITÀ.

We cannot guarantee tonal matches between the same background tiles with different thickness (10 or 20 mm).

Les assortiments des tons ne sont pas garantis pour les fonds d'une épaisseur de 10 et 20 mm.

Bei Bodenfliesen mit einer Stärke von 10 und 20 mm wird keine Einheitlichkeit der Farbtöne garantiert.

Para los fondos de espesor 10 y 20 mm no se garantiza la combinabilidad de tonalidades.

Для фоновой плитки толщиной 10 и 20 мм не гарантирована цветовая сочетаемость.

### IL PESO DEI PEZZI SPECIALI 20 MM INDICATO IN TABELLA SI RIFERISCE AL PESO DEL SINGOLO PEZZO. PER CALCOLARE IL PESO COMPLESSIVO DEL MATERIALE IMBALLATO OCCORRERÀ AGGIUNGERE AL PESO IN TABELLA IL PESO DELL'IMBALLO E DELLA PALETTA (PESO VARIABILE DA 10 A 30 KG IN FUNZIONE DELLA QUANTITÀ E DELLA TIPOLOGIA DEI PEZZI SPECIALI RICHIESTI).

The weight of the 20 mm TRIMS stated in the table refers to the weight of each trim. - To calculate the total weight of the packed material, you will need to add the combined weight of the packing materials and the pallet (weight ranging from 10 to 30kg depending on the quantity and the type of the trims required) to the weight stated in the table.

Le poids des PIÈCES SPÉCIALES 20 mm indiqué dans le tableau se réfère au poids individuel de chaque pièce. Pour calculer le poids total du matériel emballé, il faudra ajouter au poids indiqué dans le tableau le poids de l'emballage et de la palette (poids variable de 10 à 30 kg en fonction de la quantité et du type de PIÈCES SPÉCIALES demandées).

Das in der Tabelle angegebene Gewicht der 20 mm-SONDERTEILE bezieht sich auf das Gewicht des Einzelteils. Zur Berechnung des Gesamtgewichts des verpackten Materials muss zum in der Tabelle aufgeführten Wert das Gewicht der Verpackung und der Palette (von 10 bis 30 kg variierbar in Abhängigkeit von der Menge und Art der gewünschten SONDERTEILE) dazugerechnet werden.

El peso de las PIEZAS ESPECIALES 20 mm indicado en la tabla se refiere al peso de cada pieza singularmente considerada. Para calcular el peso total del material embalado se deberá agregar al peso según la tabla, el peso del embalaje y del pallet (peso variable entre 10 y 30 kg en función de la cantidad y tipo de las PIEZAS ESPECIALES requeridas).

Указанный в таблице вес СПЕЦИАЛЬНЫХ ИЗДЕЛИЙ 20 мм - это вес каждого отдельного изделия. Для расчета общего веса упакованного материала необходимо добавить к указанному в таблице значению вес упаковки и поддона (вес может составлять от 10 до 30 кг, в зависимости от количества и типа заказанных СПЕЦИАЛЬНЫХ ИЗДЕЛИЙ).



#### Costa toro.

Bullnose edge.

Bord boudin.

Abgerundete Kante.

Canto redondo.

Закругленная кромка.



#### Costa retta.

Straight edge.

Bord droit.

Gerade Kante.

Canto recto.

Прямоугольная кромка.

### PAVIMENTI SOPRAELEVATI IN 20MM: LA GAMMA COMPLETA DEI SUPPORTI È DISPONIBILE NELLA "PARTE TECNICA".

Our entire range of supports for our trims is available in our "TECHNICAL SECTION".

La gamme complète des supports pour les pièces spéciaux en 20 mm d'épaisseur est disponible dans la section "PARTIE TECHNIQUE".

Alle Stelzlagervarianten für Formteile in 20mm sind unter "TECHNISCHER TEIL" angeführt.

Pavimentos sobre elevados con 20 mm: la gama completa de los soportes está disponible en la "Parte técnica".

Фальшполы с изделиями толщиной 20 мм: полный ассортимент опор приводится в "Техническом разделе".

### ATTENZIONE: Per particolari installazioni potrebbero essere necessari articoli ed accessori specifici non presenti in questo catalogo. Per queste esigenze prego riferirsi direttamente al referente commerciale La Fabbrica.

N.B. Particular items and accessories not listed in this catalogue may be required for certain laying methods. For these needs, please contact the La Fabbrica sales directly.

ATTENTION: Pour les installations particulières, certains articles et accessoires particuliers qui ne sont pas indiqués dans ce catalogue pourraient être nécessaires. Dans ces cas-là, nous vous prions de vous référer directement à la référence commerciale La Fabbrica.

ACHTUNG: Für besondere Installationen können besondere Artikel oder Sonderzubehör notwendig sein, die nicht im vorliegenden Katalog aufgeführt sind. Wenden Sie sich bitte in diesen Fällen direkt an den Vertrieb von La Fabbrica.











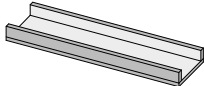
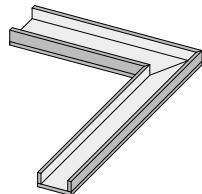
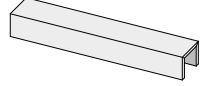
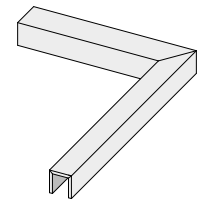

ATENCIÓN: para instalaciones particulares podrían requerirse artículos y accesorios específicos que no están presentes en este catálogo. Para tales casos rogamos contactar directamente al representante comercial de La Fabbrica.

ВНИМАНИЕ: Для особых применений могут быть необходимы специальные артикулы и аксессуары, не представленные в данном каталоге. По поводу этих вопросов просим вас обращаться непосредственно к менеджеру коммерческого отдела компании La Fabbrica.

# SPACE

20 mm RII-C

ANSI A - 137.1: 2012  
WET DYNAMIC COEFFICIENT OF FRICTION | DCOF ≥ 0,42

	Canalina Channel	Canalina - Angolo SX / DX Channel - Corner SX / DX	Cordolo U-Border	Cordolo - Angolo SX / DX U-Border - Corner SX / DX
	 20x80x8h 8"x31 1/2"x3"h	 20x80x8h 8"x31 1/2"x3"h	 13x80x13h 5"x31 1/2"x5"h	 13x80x13h 5"x31 1/2"x5"h
PLOMB 	106335	106341 SX 106338 DX	106326	106332 SX 106329 DX
CEMENT 	106334	106340 SX 106337 DX	106325	106331 SX 106328 DX
BONE 	106333	106339 SX 106336 DX	106324	106330 SX 106327 DX
PREZZO PRICE	€ 122,00 PZ/PCE	€ 150,00 PZ/PCE	€ 162,00 PZ/PCE	€ 190,00 PZ/PCE
CODICE PREZZO PRICE CODE	P189	P217	P229	P257
	<b>Epal</b> 80x120	<b>Epal</b> 80x120	<b>Epal</b> 80x120	<b>Epal</b> 80x120
IMBALLO cm h. PACKING cm h.	-	-	-	-
 x  l	1	1	1	1
m <sup>2</sup> x 	-	-	-	-
Kg x 	12,00	13,00	12,00	13,00
 x 	-	-	-	-
m <sup>2</sup> x 	-	-	-	-
Kg x 	-	-	-	-



Floor  
Bone 80x80 (31 1/2"x31 1/2") Nat. Ret. RII 20 mm

Cucina / Kitchen  
AVA Extraordinary Size Marmi Calacatta Lap. Ret.

## TRA I FONDI DI SPESSORE 10 E 20 MM NON SI GARANTISCE L'ABBINABILITÀ.

We cannot guarantee tonal matches between the same background tiles with different thickness (10 or 20 mm).  
Les assortiments des tons ne sont pas garantis pour les fonds d'une épaisseur de 10 et 20 mm.  
Bei Bodenfliesen mit einer Stärke von 10 und 20 mm wird keine Einheitlichkeit der Farbtöne garantiert.  
Para los fondos de espesor 10 y 20 mm no se garantiza la combinabilidad de tonalidades.  
Для фоновой плитки толщиной 10 и 20 мм не гарантирована цветовая сочетаемость.



**Costa toro.**  
Bullnose edge.  
Bord boudin.  
Abgerundete Kante.  
Canto redondo.  
Закругленная кромка.



**Costa retta.**  
Straight edge.  
Bord droit.  
Gerade Kante.  
Canto recto.  
Прямоугольная кромка.

## IL PESO DEI PEZZI SPECIALI 20 MM INDICATO IN TABELLA SI RIFERISCE AL PESO DEL SINGOLO PEZZO. PER CALCOLARE IL PESO COMPLESSIVO DEL MATERIALE IMBALLATO OCCORRERÀ AGGIUNGERE AL PESO IN TABELLA IL PESO DELL'IMBALLO E DELLA PALETTA (PESO VARIABILE DA 10 A 30 KG IN FUNZIONE DELLA QUANTITÀ E DELLA TIPOLOGIA DEI PEZZI SPECIALI RICHIESTI).

The weight of the 20 mm TRIMS stated in the table refers to the weight of each trim. - To calculate the total weight of the packed material, you will need to add the combined weight of the packing materials and the pallet (weight ranging from 10 to 30kg depending on the quantity and the type of the trims required) to the weight stated in the table.  
Le poids des PIÈCES SPECIALES 20 mm indiqué dans le tableau se réfère au poids individuel de chaque pièce. Pour calculer le poids total du matériel emballé, il faudra ajouter au poids indiqué dans le tableau le poids de l'emballage et de la palette (poids variable de 10 à 30 kg en fonction de la quantité et du type de PIÈCES SPECIALES demandées).  
Das in der Tabelle angegebene Gewicht der 20 mm-SONDERTEILE bezieht sich auf das Gewicht des Einzelteils. Zur Berechnung des Gesamtgewichts des verpackten Materials muss zum in der Tabelle aufgeführten Wert das Gewicht der Verpackung und der Palette (von 10 bis 30 kg variierbar in Abhängigkeit von der Menge und Art der gewünschten SONDERTEILE) dazugerechnet werden.  
El peso de las PIEZAS ESPECIALES 20 mm indicado en la tabla se refiere al peso de cada pieza singularmente considerada. Para calcular el peso total del material embalado se deberá agregar al peso según la tabla, el peso del embalaje y del palet (peso variable entre 10 y 30 kg en función de la cantidad y tipo de las PIEZAS ESPECIALES requeridas).  
Указанный в таблице вес СПЕЦИАЛЬНЫХ ИЗДЕЛИЙ 20 мм - это вес каждого отдельного изделия. Для расчета общего веса упакованного материала необходимо добавить к указанному в таблице значению вес упаковки и поддона (вес может составлять от 10 до 30 кг, в зависимости от количества и типа заказанных СПЕЦИАЛЬНЫХ ИЗДЕЛИЙ).

**ATTENZIONE:** Per particolari installazioni potrebbero essere necessari articoli ed accessori specifici non presenti in questo catalogo. Per queste esigenze prego riferirsi direttamente al referente commerciale La Fabbrica.  
N.B. Particular items and accessories not listed in this catalogue may be required for certain laying methods. For these needs, please contact the La Fabbrica sales directly.

**ATTENTION:** Pour les installations particulières, certains articles et accessoires particuliers qui ne sont pas indiqués dans ce catalogue pourraient être nécessaires. Dans ces cas-là, nous vous prions de vous référer directement à la référence commerciale La Fabbrica.  
**ACHTUNG:** Für besondere Installationen können besondere Artikel oder Sonderzubehör notwendig sein, die nicht im vorliegenden Katalog aufgeführt sind. Wenden Sie sich bitte in diesen Fällen direkt an den Vertrieb von La Fabbrica.  
**ATENCIÓN:** para instalaciones particulares podrían requerirse artículos y accesorios específicos que no están presentes en este catálogo. Para tales casos rogamos contactar directamente al representante comercial de La Fabbrica.  
**ВНИМАНИЕ:** Для особых применений могут быть необходимы специальные артикулы и аксессуары, не представленные в данном каталоге. По поводу этих вопросов просим вас обращаться непосредственно к менеджеру коммерческого отдела компании La Fabbrica.



Floor: Georgetown Net 60x60 (24"x24") Lap. Ret. - Georgetown Tweed 60x60 (24"x24") Lap. Ret.

# STEELISTIC

GRES PORCELLANATO COLORATO IN MASSA . COLORED BODY PORCELAIN STONEWARE  
GRÈS CÉRAME COLORÉ DANS LA MASSE . EINGEFÄRBTES FEINSTEINZEUG  
GRES PORCELÁNICO COLOREADO EN MASA . КЕРАМОГРАНИТ ОКРАШЕННЫЙ В МАССЕ  
ISO 13006 - G - B1a (E ≤ 0,5%) - UNI EN 14411 - G

100% DESIGN  
AND PRODUCTION  
OF ITALY

V2  
SHADE SPECTRUM  
MODERATE

## INDOOR

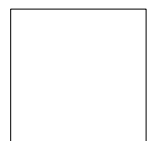

60x60 . 24"x24"  
Lap. Ret.

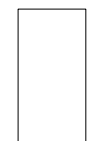

30x60 . 12"x24"  
Lap. Ret.

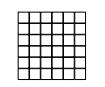

Mosaico  
30x30 . 12"x12"  
Lap. Ret.

10 mm

modular system

SVILUPPO GRAFICO PER FORMATO  
Pattern by size  
Développement graphique par format  
Grafischer Entwurf für Format  
Desarrollo gráfico por formato  
Варианты графики для каждого формата

60x60  
10 mm

30x60  
10 mm

1

2



# STEELISTIC

10 mm



INDOOR  
Floor  
Ginza Tweed 60x60 (24"x24") Lap. Ret.  
Ginza Square 60x60 (24"x24") Lap. Ret.

OUTDOOR  
Floor  
Amazon Nawa 40x120 (16"x48") Nat. Ret. R11 20 mm

# STEELISTIC

10 mm



Wall  
AVA Extraordinary Size Marmi Crema Marfil 240x120 (96"x48") Lap. Ret.

Floor  
Weho Tweed 60x60 (24"x24") Lap. Ret.

Wall  
Mosaico Brera Net/Tweed 30x30 (12"x12") Lap. Ret.

Floor  
Mayfair Net 60x60 (24"x24") Lap. Ret.  
Brera Tweed 60x60 (24"x24") Lap. Ret.

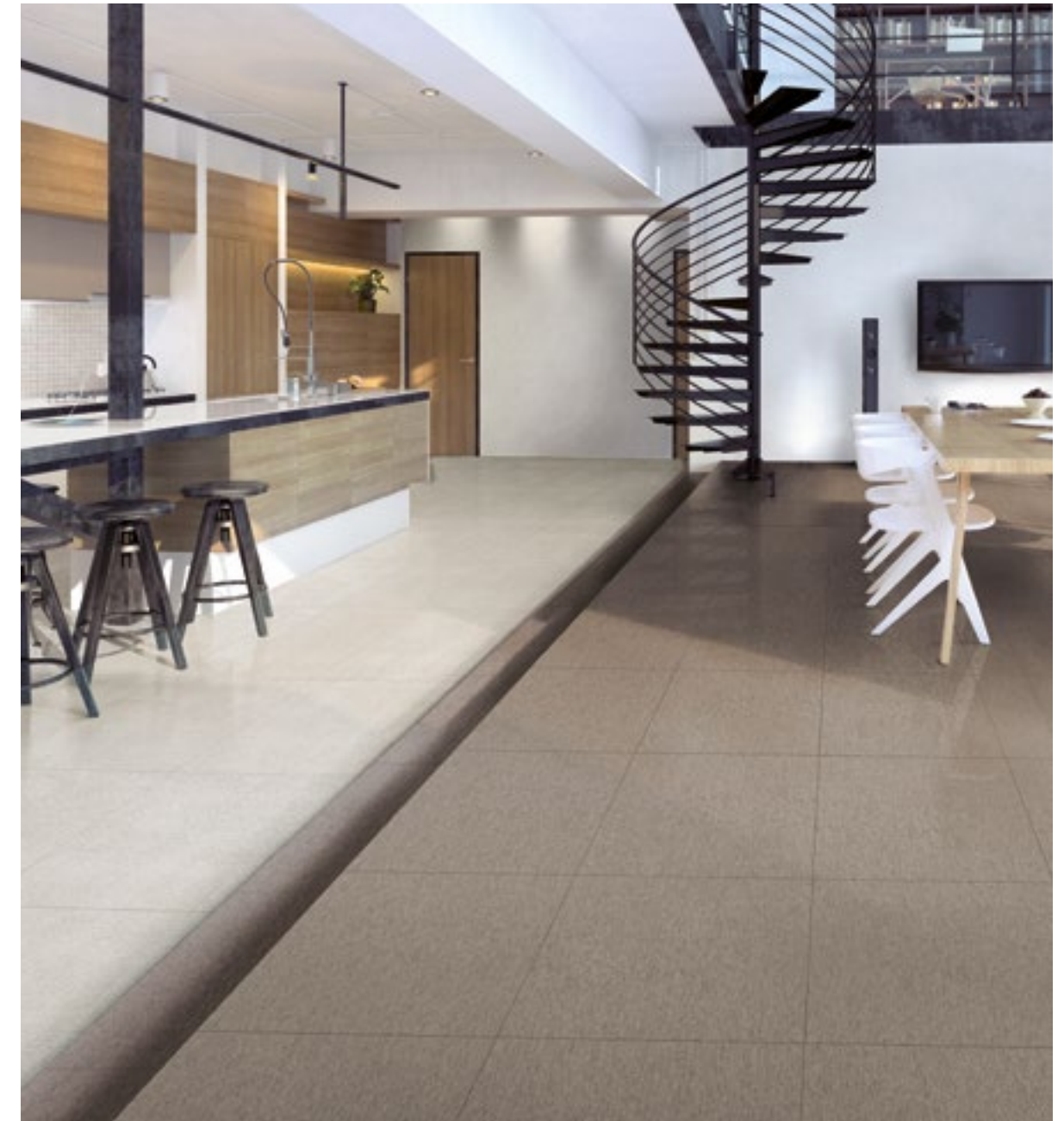

# STEELISTIC

## WEHO

10 mm

INDOOR

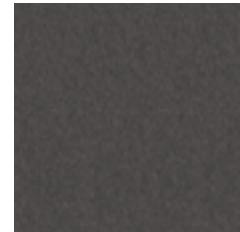

**I34005**  
Net  
60x60 . 24"x24"  
Lap. Ret.



**I34010**  
Net  
30x60 . 12"x24"  
Lap. Ret.

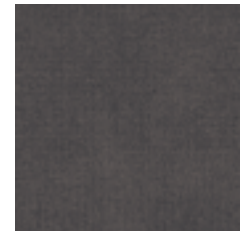

**I34025**  
Tweed  
60x60 . 24"x24"  
Lap. Ret.



**I34030**  
Tweed  
30x60 . 12"x24"  
Lap. Ret.



**I34020**  
Decoro Square  
60x60 . 24"x24"  
Lap. Ret.

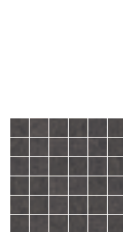

**I34105**  
Mosaico Net/ Tweed  
30x30 . 12"x12"  
Lap. Ret.

modular system

## GINZA

10 mm

INDOOR

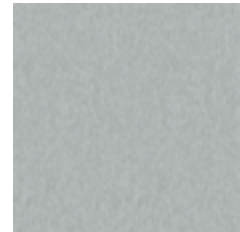

**I34003**  
Net  
60x60 . 24"x24"  
Lap. Ret.

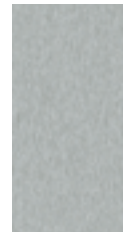

**I34008**  
Net  
30x60 . 12"x24"  
Lap. Ret.



**I34023**  
Tweed  
60x60 . 24"x24"  
Lap. Ret.



**I34028**  
Tweed  
30x60 . 12"x24"  
Lap. Ret.



**I34018**  
Decoro Square  
60x60 . 24"x24"  
Lap. Ret.

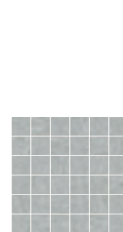

**I34103**  
Mosaico Net/ Tweed  
30x30 . 12"x12"  
Lap. Ret.

modular system

## BRERA

10 mm

INDOOR

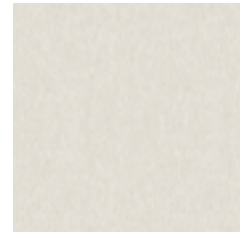

**I34001**  
Net  
60x60 . 24"x24"  
Lap. Ret.

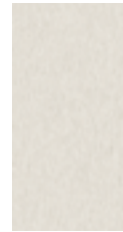

**I34006**  
Net  
30x60 . 12"x24"  
Lap. Ret.

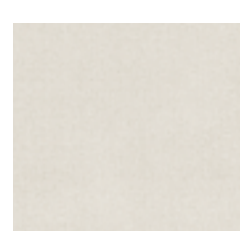

**I34021**  
Tweed  
60x60 . 24"x24"  
Lap. Ret.

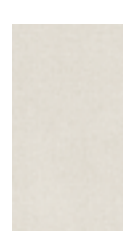

**I34026**  
Tweed  
30x60 . 12"x24"  
Lap. Ret.



**I34016**  
Decoro Square  
60x60 . 24"x24"  
Lap. Ret.

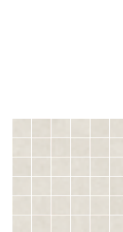

**I34101**  
Mosaico Net/ Tweed  
30x30 . 12"x12"  
Lap. Ret.

modular system

## GEORGETOWN

10 mm

INDOOR

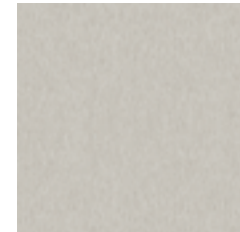

**I34002**  
Net  
60x60 . 24"x24"  
Lap. Ret.

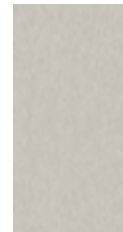

**I34007**  
Net  
30x60 . 12"x24"  
Lap. Ret.

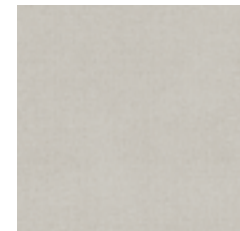

**I34022**  
Tweed  
60x60 . 24"x24"  
Lap. Ret.



**I34027**  
Tweed  
30x60 . 12"x24"  
Lap. Ret.

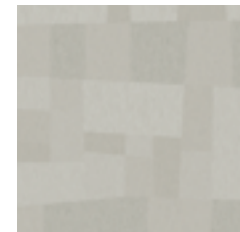

**I34017**  
Decoro Square  
60x60 . 24"x24"  
Lap. Ret.

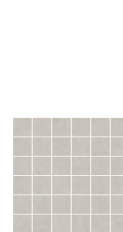

**I34102**  
Mosaico Net/ Tweed  
30x30 . 12"x12"  
Lap. Ret.

modular system

## MAYFAIR

10 mm

INDOOR

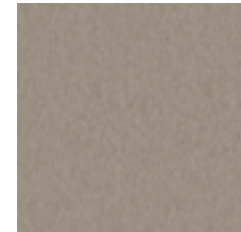

**I34004**  
Net  
60x60 . 24"x24"  
Lap. Ret.

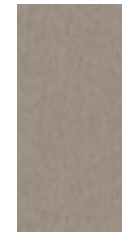

**I34009**  
Net  
30x60 . 12"x24"  
Lap. Ret.



**I34024**  
Tweed  
60x60 . 24"x24"  
Lap. Ret.

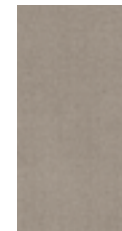

**I34029**  
Tweed  
30x60 . 12"x24"  
Lap. Ret.



**I34019**  
Decoro Square  
60x60 . 24"x24"  
Lap. Ret.

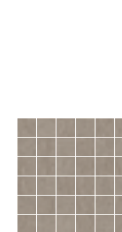

**I34104**  
Mosaico Net/ Tweed  
30x30 . 12"x12"  
Lap. Ret.

modular system

\* IN OGNI SCATOLA LA COMBINAZIONE DEI SOGGETTI È DEL TUTTO CASUALE. LO STESSO SOGGETTO POTREBBE ESSERE RIPETUTO OPPURE POTREBBE NON ESSERE PRESENTE NELLA SCATOLA.

Each box contains a random assortment of the designs available. The same design may be repeated and certain designs may not be included in the box.

La combinaison des motifs à l'intérieur de chaque boîte est absolument fortuite. Le même motif pourrait être répété ou ne pas se trouver à l'intérieur de la boîte.









Die Zusammenstellung der Motive ist in jedem Karton vollkommen zufällig. Das selbe Motiv könnte sich wiederholen oder nicht im Karton vorhanden sein.

En cada caja la combinación de los temas es del todo casual. En una caja un tema puede estar repetido o estar ausente.

Сочетание мотивов в каждой коробке является совершенно случайным. Один и тот же мотив может присутствовать в коробке несколько раз или, наоборот, отсутствовать.

# STEELISTIC

10 mm

	modular system											
	60x60 24"x24" Lap. Ret.		30x60 12"x24" Lap. Ret.		Decoro Decorative tile *	Mosaico Mosaic	Battiscopa Skirting	Gradino costa retta Straight-edge step **		Gradino costa retta - Angolo SX / DX Straight-edge step - LH/RH corner **		
	NET	TWEED	NET	TWEED	SQUARE	NET/ TWEED	NET	TWEED	NET	TWEED	NET	TWEED
WEHO	134005	134025	134010	134030	134020	134105	134205	134210	134313	134328	134315 SX 134314 DX	134330 SX 134329 DX
GINZA	134003	134023	134008	134028	134018	134103	134203	134208	134307	134322	134309 SX 134308 DX	134324 SX 134323 DX
BRERA	134001	134021	134006	134026	134016	134101	134201	134206	134301	134316	134303 SX 134302 DX	134318 SX 134317 DX
GEORGETOWN	134002	134022	134007	134027	134017	134102	134202	134207	134304	134319	134306 SX 134305 DX	134321 SX 134320 DX
MAYFAIR	134004	134024	134009	134029	134019	134104	134204	134209	134310	134325	134312 SX 134311 DX	134327 SX 134326 DX
PREZZO PRICE	€ 54,00 m <sup>2</sup>		€ 54,00 m <sup>2</sup>		€ 56,00 m <sup>2</sup>	€ 120,00 m <sup>2</sup>	€ 6,00 PZ/PCE		€ 76,00 PZ/PCE		€ 106,00 PZ/PCE	
CODICE PREZZO PRICE CODE	MI21		MI21		MI23	MI87	P021		PI43		PI73	
	Pallet 80x120		Pallet 80x120		Pallet 80x120	Pallet 80x120	Pallet 80x120	Pallet 80x120	Pallet 80x120		Pallet 80x120	
IMBALLO cm h. PACKING cm h.	75		75		75	75	-	-	-		-	
 x 	3		6		3	6	15	4	2		-	
m <sup>2</sup> x 	1,08		1,08		1,08	0,54	0,63	-	-		-	
Kg x 	25,00		25,00		25,00	15,00	14,70	20,00	11,00		-	
 x 	40		40		40	54	-	-	-		-	
m <sup>2</sup> x 	43,20		43,20		43,20	29,16	-	-	-		-	
Kg x 	1.020		1.020		1.020	830	-	-	-		-	

\* IN OGNI SCATOLA LA COMBINAZIONE DEI SOGGETTI È DEL TUTTO CASUALE. LO STESSO SOGGETTO POTREBBE ESSERE RIPETUTO OPPURE POTREBBE NON ESSERE PRESENTE NELLA SCATOLA.

Each box contains a random assortment of the designs available. The same design may be repeated and certain designs may not be included in the box.  
La combinaison des motifs à l'intérieur de chaque boîte est absolument fortuite. Le même motif pourrait être répété ou ne pas se trouver à l'intérieur de la boîte.  
Die Zusammenstellung der Motive ist in jedem Karton vollkommen zufällig. Das selbe Motiv könnte sich wiederholen oder nicht im Karton vorhanden sein.  
En cada caja la combinación de los temas es del todo casual. En una caja un tema puede estar repetido o estar ausente.  
Сочетание мотивов в каждой коробке является совершенно случайным. Один и тот же мотив может присутствовать в коробке несколько раз или, наоборот, отсутствовать.

\*\* A DISPOSIZIONE SOLO SU RICHIESTA. TEMPI DI CONSEGNA: 30GG.

Available upon request only. Delivery terms: 30 days.  
Disponibile seulement sur requête. Délais de livraison: 30 jours.  
Verfügbar auf Anfrage. Lieferzeit: 30 Tage.  
Disponibile sólo bajo pedido. Plazo de entrega: 30 días.  
Изготавливается только по специальной заявке. Срок поставки: 30 дней.

PER IL GRADINO NON SI GARANTISCE LA STESSA TONALITÀ DEL FONDO.

We cannot guarantee that the shade of the stair tile will be the same as the background tile.  
Pour la marche, nous ne garantissons pas la même tonalité du fond.  
Für die Stufe wird nicht der gleiche Farbton der Grundfliese garantiert.  
Para el peldaño no se garantiza el mismo tono del fondo.  
Для ступени не гарантирована одинаковость тона с фоном.



Wall  
Mosaico Brera Net / Tweed 30x30 (12"x12") Lap. Ret.

Floor  
Brera Net 60x60 (24"x24") Lap. Ret.



Civilization of Beauty

INDOOR

CHROMATIC..... 362

# DESIGN

---

Design . Design . Design . Diseños . Дизайн .



Decors by MASSIMO IOSA GHINI

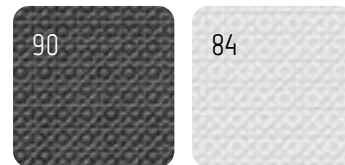

Wall: **14** 30x60 (12"x24") decoro lucido Lap. Ret. - **29** 7,5x30 (3"x12") Nat. Ret.  
 Floor: **84** 7,5x30 (3"x12") Nat. Ret. - **07** 7,5x30 (3"x12") Nat. Ret. - **25** 7,5x30 (3"x12") Nat. Ret. - **14** 7,5x30 (3"x12") Nat. Ret. - **30** 7,5x30 (3"x12") Nat. Ret.



GRES PORCELLANATO . PORCELAIN TILES  
 GRES CÉRAMÉ . FEINSTEINZEUG  
 GRES PORCELÁNICO . КЕРАМОГРАНИТ  
 ISO 13006 - G - B1a (E ≤ 0,5%) - UNI EN 14411 - G

100% DESIGN  
 AND PRODUCTION  
 OF ITALY



INDOOR

R10-B

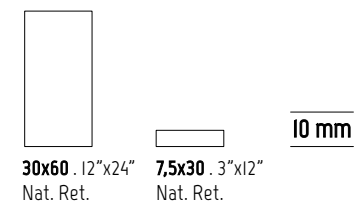

on demand

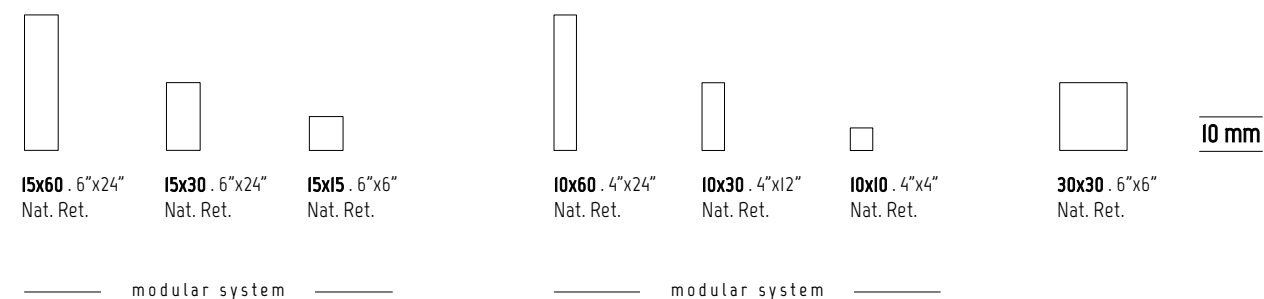

SVILUPPO GRAFICO PER FORMATO Pattern by size Développement graphique par format Grafischer Entwurf für Format Desarrollo gráfico por formato Варианты графики для каждого формата	30x60 10 mm	7,5x30 10 mm	15x60 10 mm	15x30 10 mm	15x15 10 mm	10x60 10 mm	10x30 10 mm	10x10 10 mm	30x30 10 mm
	1	8	2	4	8	3	6	18	2

# CHROMATIC

10 mm R10-B



Wall  
77 7,5x30 (3"x12") Nat. Ret.  
67 7,5x30 (3"x12") Nat. Ret.  
51 7,5x30 (3"x12") Nat. Ret.

Floor  
42 30x60 (12"x24") Nat. Ret.

# CHROMATIC

90

INDOOR

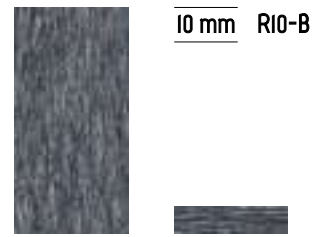

**146190**  
30x60 . 12"x24"  
Nat. Ret.

**146090**  
7.5x30 . 3"x12"  
Nat. Ret.

88

INDOOR

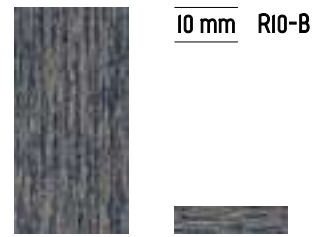

**146188**  
30x60 . 12"x24"  
Nat. Ret.

**146088**  
7.5x30 . 3"x12"  
Nat. Ret.

42

INDOOR

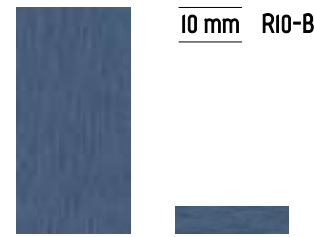

**146142**  
30x60 . 12"x24"  
Nat. Ret.

**146042**  
7.5x30 . 3"x12"  
Nat. Ret.

82

INDOOR

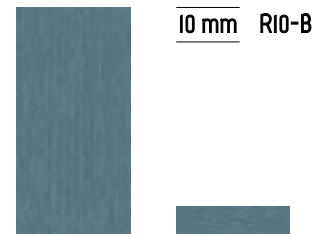

**146182**  
30x60 . 12"x24"  
Nat. Ret.

**146082**  
7.5x30 . 3"x12"  
Nat. Ret.

31

INDOOR

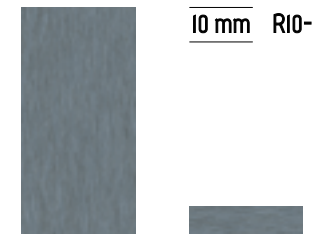

**146131**  
30x60 . 12"x24"  
Nat. Ret.

**146031**  
7.5x30 . 3"x12"  
Nat. Ret.

33

INDOOR

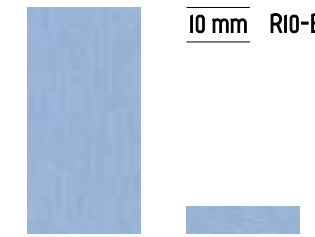

**146133**  
30x60 . 12"x24"  
Nat. Ret.

**146033**  
7.5x30 . 3"x12"  
Nat. Ret.

45

INDOOR

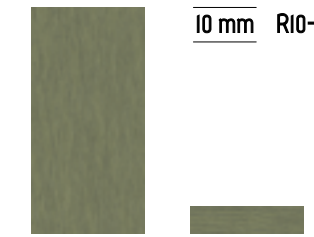

**146145**  
30x60 . 12"x24"  
Nat. Ret.

**146045**  
7.5x30 . 3"x12"  
Nat. Ret.

77

INDOOR

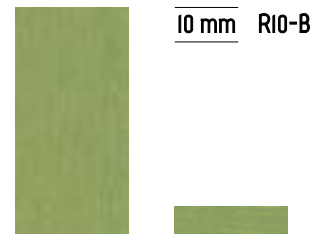

**146177**  
30x60 . 12"x24"  
Nat. Ret.

**146077**  
7.5x30 . 3"x12"  
Nat. Ret.

ON DEMAND



**146A90**  
15x60 . 6"x24"  
Nat. Ret.

**146B90**  
15x30 . 6"x12"  
Nat. Ret.

**146C90**  
15x15 . 6"x6"  
Nat. Ret.

— modular system —

ON DEMAND



**146A88**  
15x60 . 6"x24"  
Nat. Ret.

**146B88**  
15x30 . 6"x12"  
Nat. Ret.

**146C88**  
15x15 . 6"x6"  
Nat. Ret.

— modular system —

ON DEMAND

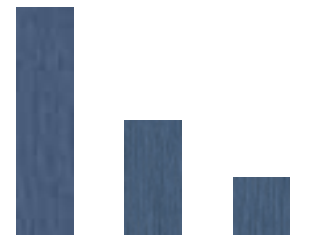

**146A42**  
15x60 . 6"x24"  
Nat. Ret.

**146B42**  
15x30 . 6"x12"  
Nat. Ret.

**146C42**  
15x15 . 6"x6"  
Nat. Ret.

— modular system —

ON DEMAND

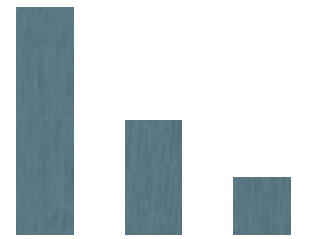

**146A82**  
15x60 . 6"x24"  
Nat. Ret.

**146B82**  
15x30 . 6"x12"  
Nat. Ret.

**146C82**  
15x15 . 6"x6"  
Nat. Ret.

— modular system —

ON DEMAND

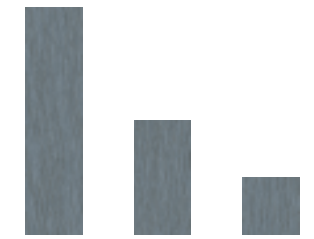

**146A31**  
15x60 . 6"x24"  
Nat. Ret.

**146B31**  
15x30 . 6"x12"  
Nat. Ret.

**146C31**  
15x15 . 6"x6"  
Nat. Ret.

— modular system —

ON DEMAND

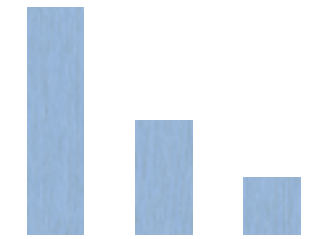

**146A33**  
15x60 . 6"x24"  
Nat. Ret.

**146B33**  
15x30 . 6"x12"  
Nat. Ret.

**146C33**  
15x15 . 6"x6"  
Nat. Ret.

— modular system —

ON DEMAND

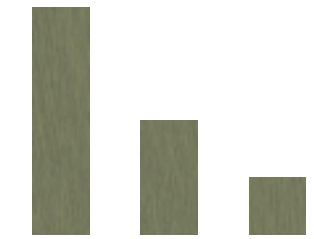

**146A45**  
15x60 . 6"x24"  
Nat. Ret.

**146B45**  
15x30 . 6"x12"  
Nat. Ret.

**146C45**  
15x15 . 6"x6"  
Nat. Ret.

— modular system —

ON DEMAND



**146A77**  
15x60 . 6"x24"  
Nat. Ret.

**146B77**  
15x30 . 6"x12"  
Nat. Ret.

**146C77**  
15x15 . 6"x6"  
Nat. Ret.

— modular system —



**146D90**  
10x60 . 4"x24"  
Nat. Ret.

**146E90**  
10x30 . 4"x12"  
Nat. Ret.

**146F90**  
10x10 . 4"x4"  
Nat. Ret.

— modular system —



**146D88**  
10x60 . 4"x24"  
Nat. Ret.

**146E88**  
10x30 . 4"x12"  
Nat. Ret.

**146F88**  
10x10 . 4"x4"  
Nat. Ret.

— modular system —

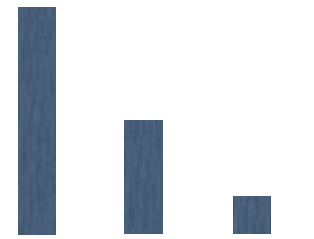

**146D42**  
10x60 . 4"x24"  
Nat. Ret.

**146E42**  
10x30 . 4"x12"  
Nat. Ret.

**146F42**  
10x10 . 4"x4"  
Nat. Ret.

— modular system —

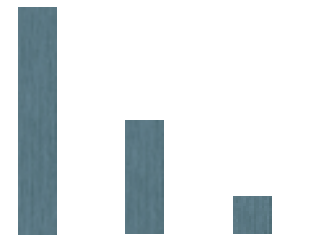

**146D82**  
10x60 . 4"x24"  
Nat. Ret.

**146E82**  
10x30 . 4"x12"  
Nat. Ret.

**146F82**  
10x10 . 4"x4"  
Nat. Ret.

— modular system —



**146D31**  
10x60 . 4"x24"  
Nat. Ret.

**146E31**  
10x30 . 4"x12"  
Nat. Ret.

**146F31**  
10x10 . 4"x4"  
Nat. Ret.

— modular system —

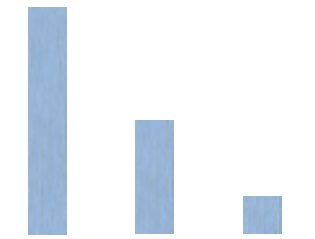

**146D33**  
10x60 . 4"x24"  
Nat. Ret.

**146E33**  
10x30 . 4"x12"  
Nat. Ret.

**146F33**  
10x10 . 4"x4"  
Nat. Ret.

— modular system —

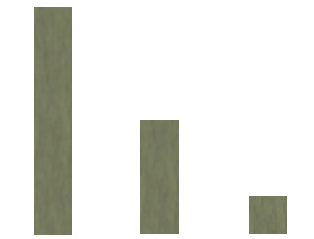

**146D45**  
10x60 . 4"x24"  
Nat. Ret.

**146E45**  
10x30 . 4"x12"  
Nat. Ret.

**146F45**  
10x10 . 4"x4"  
Nat. Ret.

— modular system —

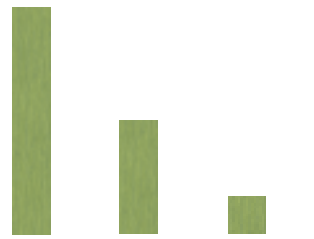

**146D77**  
10x60 . 4"x24"  
Nat. Ret.

**146E77**  
10x30 . 4"x12"  
Nat. Ret.

**146F77**  
10x10 . 4"x4"  
Nat. Ret.

— modular system —



**146G90**  
30x30 . 12"x12"  
Nat. Ret.

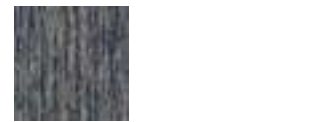

**146G88**  
30x30 . 12"x12"  
Nat. Ret.



**146G42**  
30x30 . 12"x12"  
Nat. Ret.



**146G82**  
30x30 . 12"x12"  
Nat. Ret.



**146G31**  
30x30 . 12"x12"  
Nat. Ret.



**146G33**  
30x30 . 12"x12"  
Nat. Ret.



**146G45**  
30x30 . 12"x12"  
Nat. Ret.



**146G77**  
30x30 . 12"x12"  
Nat. Ret.



# CHROMATIC

21

INDOOR



10 mm RIO-B

I46I21  
30x60 . 12"x24"  
Nat. Ret.

I46021  
7,5x30 . 3"x12"  
Nat. Ret.

84

INDOOR



10 mm RIO-B

I46I84  
30x60 . 12"x24"  
Nat. Ret.

I46084  
7,5x30 . 3"x12"  
Nat. Ret.

67

INDOOR



10 mm RIO-B

I46I67  
30x60 . 12"x24"  
Nat. Ret.

I46067  
7,5x30 . 3"x12"  
Nat. Ret.

29

INDOOR



10 mm RIO-B

I46I29  
30x60 . 12"x24"  
Nat. Ret.

I46029  
7,5x30 . 3"x12"  
Nat. Ret.

14

INDOOR



10 mm RIO-B

I46I14  
30x60 . 12"x24"  
Nat. Ret.

I46014  
7,5x30 . 3"x12"  
Nat. Ret.

51

INDOOR



10 mm RIO-B

I46I51  
30x60 . 12"x24"  
Nat. Ret.

I46051  
7,5x30 . 3"x12"  
Nat. Ret.

48

INDOOR



10 mm RIO-B

I46I48  
30x60 . 12"x24"  
Nat. Ret.

I46048  
7,5x30 . 3"x12"  
Nat. Ret.

08

INDOOR



10 mm RIO-B

I46I08  
30x60 . 12"x24"  
Nat. Ret.

I46008  
7,5x30 . 3"x12"  
Nat. Ret.

ON DEMAND



I46A21  
15x60 . 6"x24"  
Nat. Ret.

I46B21  
15x30 . 6"x12"  
Nat. Ret.

I46C21  
15x15 . 6"x6"  
Nat. Ret.

— modular system —

ON DEMAND



I46A84  
15x60 . 6"x24"  
Nat. Ret.

I46B84  
15x30 . 6"x12"  
Nat. Ret.

I46C84  
15x15 . 6"x6"  
Nat. Ret.

— modular system —

ON DEMAND



I46A67  
15x60 . 6"x24"  
Nat. Ret.

I46B67  
15x30 . 6"x12"  
Nat. Ret.

I46C67  
15x15 . 6"x6"  
Nat. Ret.

— modular system —

ON DEMAND



I46A29  
15x60 . 6"x24"  
Nat. Ret.

I46B29  
15x30 . 6"x12"  
Nat. Ret.

I46C29  
15x15 . 6"x6"  
Nat. Ret.

— modular system —

ON DEMAND



I46A14  
15x60 . 6"x24"  
Nat. Ret.

I46B14  
15x30 . 6"x12"  
Nat. Ret.

I46C14  
15x15 . 6"x6"  
Nat. Ret.

— modular system —

ON DEMAND



I46A51  
15x60 . 6"x24"  
Nat. Ret.

I46B51  
15x30 . 6"x12"  
Nat. Ret.

I46C51  
15x15 . 6"x6"  
Nat. Ret.

— modular system —

ON DEMAND



I46A48  
15x60 . 6"x24"  
Nat. Ret.

I46B48  
15x30 . 6"x12"  
Nat. Ret.

I46C48  
15x15 . 6"x6"  
Nat. Ret.

— modular system —

ON DEMAND



I46A08  
15x60 . 6"x24"  
Nat. Ret.

I46B08  
15x30 . 6"x12"  
Nat. Ret.

I46C08  
15x15 . 6"x6"  
Nat. Ret.

— modular system —



I46D21  
10x60 . 4"x24"  
Nat. Ret.

I46E21  
10x30 . 4"x12"  
Nat. Ret.

I46F21  
10x10 . 4"x4"  
Nat. Ret.

— modular system —



I46D84  
10x60 . 4"x24"  
Nat. Ret.

I46E84  
10x30 . 4"x12"  
Nat. Ret.

I46F84  
10x10 . 4"x4"  
Nat. Ret.

— modular system —



I46D67  
10x60 . 4"x24"  
Nat. Ret.

I46E67  
10x30 . 4"x12"  
Nat. Ret.

I46F67  
10x10 . 4"x4"  
Nat. Ret.

— modular system —

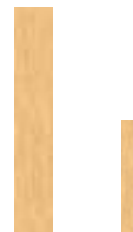

I46D29  
10x60 . 4"x24"  
Nat. Ret.

I46E29  
10x30 . 4"x12"  
Nat. Ret.

I46F29  
10x10 . 4"x4"  
Nat. Ret.

— modular system —



I46D14  
10x60 . 4"x24"  
Nat. Ret.

I46E14  
10x30 . 4"x12"  
Nat. Ret.

I46F14  
10x10 . 4"x4"  
Nat. Ret.

— modular system —



I46D51  
10x60 . 4"x24"  
Nat. Ret.

I46E51  
10x30 . 4"x12"  
Nat. Ret.

I46F51  
10x10 . 4"x4"  
Nat. Ret.

— modular system —



I46D48  
10x60 . 4"x24"  
Nat. Ret.

I46E48  
10x30 . 4"x12"  
Nat. Ret.

I46F48  
10x10 . 4"x4"  
Nat. Ret.

— modular system —



I46D08  
10x60 . 4"x24"  
Nat. Ret.

I46E08  
10x30 . 4"x12"  
Nat. Ret.

I46F08  
10x10 . 4"x4"  
Nat. Ret.

— modular system —



I46G21  
30x30 . 12"x12"  
Nat. Ret.



I46G84  
30x30 . 12"x12"  
Nat. Ret.



I46G67  
30x30 . 12"x12"  
Nat. Ret.



I46G29  
30x30 . 12"x12"  
Nat. Ret.



I46G14  
30x30 . 12"x12"  
Nat. Ret.



I46G51  
30x30 . 12"x12"  
Nat. Ret.



I46G48  
30x30 . 12"x12"  
Nat. Ret.



I46G08  
30x30 . 12"x12"  
Nat. Ret.

# CHROMATIC

57

INDOOR

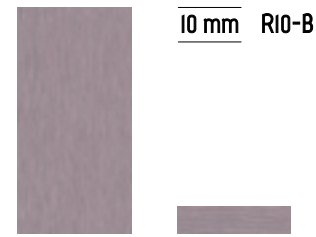

**I46I57**  
30x60 . 12"x24"  
Nat. Ret.

**I46057**  
7,5x30 . 3"x12"  
Nat. Ret.

34

INDOOR

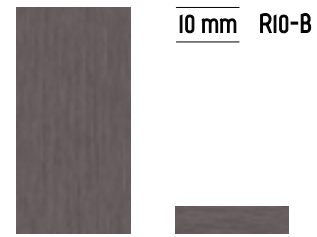

**I46I34**  
30x60 . 12"x24"  
Nat. Ret.

**I46034**  
7,5x30 . 3"x12"  
Nat. Ret.

LUCIDO

INDOOR

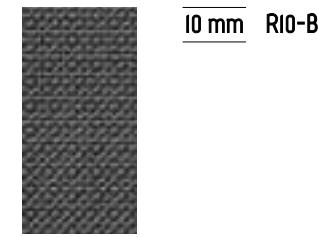

**I46490**  
Decoro  
30x60 . 12"x24"  
Nat. Ret.

OPACO

INDOOR

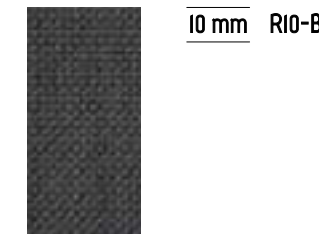

**I46390**  
Decoro  
30x60 . 12"x24"  
Nat. Ret.

LUCIDO

INDOOR

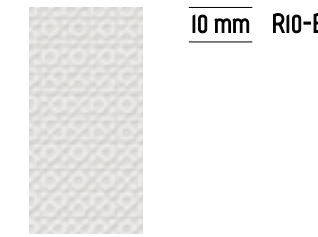

**I46484**  
Decoro  
30x60 . 12"x24"  
Nat. Ret.

OPACO

INDOOR

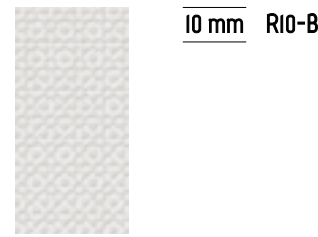

**I46384**  
Decoro  
30x60 . 12"x24"  
Nat. Ret.

ON DEMAND



**I46A57** 15x60 . 6"x24"  
Nat. Ret.

**I46B57** 15x30 . 6"x12"  
Nat. Ret.

**I46C57** 15x15 . 6"x6"  
Nat. Ret.

— modular system —

ON DEMAND

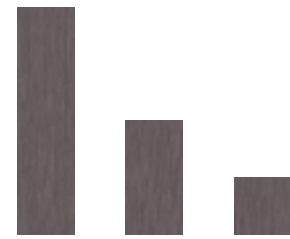

**I46A34** 15x60 . 6"x24"  
Nat. Ret.

**I46B34** 15x30 . 6"x12"  
Nat. Ret.

**I46C34** 15x15 . 6"x6"  
Nat. Ret.

— modular system —



**I46057** 10x60 . 4"x24"  
Nat. Ret.

**I46E57** 10x30 . 4"x12"  
Nat. Ret.

**I46F57** 10x10 . 4"x4"  
Nat. Ret.

— modular system —



**I46034** 10x60 . 4"x24"  
Nat. Ret.

**I46E34** 10x30 . 4"x12"  
Nat. Ret.

**I46F34** 10x10 . 4"x4"  
Nat. Ret.

— modular system —

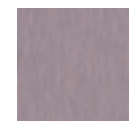

**I46G57**  
30x30 . 12"x12"  
Nat. Ret.



**I46G34**  
30x30 . 12"x12"  
Nat. Ret.



# CHROMATIC

10 mm RIO-B

		on demand		modular system		modular system				
		30x60 12"x24" Nat. Ret.	7,5x30 3"x12" Nat. Ret.	15x60 6"x24" Nat. Ret.	15x30 6"x12" Nat. Ret.	15x15 6"x6" Nat. Ret.	10x60 4"x24" Nat. Ret.	10x30 4"x12" Nat. Ret.	10x10 4"x4" Nat. Ret.	30x30 12"x12" Nat. Ret.
90		I46I90	I46090	I46A90	I46B90	I46C90	I46D90	I46E90	I46F90	I46G90
88		I46I88	I46088	I46A88	I46B88	I46C88	I46D88	I46E88	I46F88	I46G88
42		I46I42	I46042	I46A42	I46B42	I46C42	I46D42	I46E42	I46F42	I46G42
82		I46I82	I46082	I46A82	I46B82	I46C82	I46D82	I46E82	I46F82	I46G82
31		I46I31	I46031	I46A31	I46B31	I46C31	I46D31	I46E31	I46F31	I46G31
33		I46I33	I46033	I46A33	I46B33	I46C33	I46D33	I46E33	I46F33	I46G33
45		I46I45	I46045	I46A45	I46B45	I46C45	I46D45	I46E45	I46F45	I46G45
77		I46I77	I46077	I46A77	I46B77	I46C77	I46D77	I46E77	I46F77	I46G77
21		I46I21	I46021	I46A21	I46B21	I46C21	I46D21	I46E21	I46F21	I46G21
PREZZO PRICE		€ 42,00 m <sup>2</sup>	€ 66,00 m <sup>2</sup>	€ 54,00 m <sup>2</sup>	€ 58,00 m <sup>2</sup>	€ 54,00 m <sup>2</sup>	€ 54,00 m <sup>2</sup>	€ 60,00 m <sup>2</sup>	€ 74,00 m <sup>2</sup>	€ 48,00 m <sup>2</sup>
CODICE PREZZO PRICE CODE		M101	M133	M121	M125	M131	M121	M127	M141	M113
Pallet 80x120		Pallet 80x120	Pallet 80x120	Pallet 80x120	Pallet 80x120	Pallet 80x120	Pallet 80x120	Pallet 80x120	Pallet 80x120	Pallet 80x120
IMBALLO cm h. PACKING cm h.		75	75	75	75	75	75	75	75	75
		6	40	10	22	44	9	19	69	12
m <sup>2</sup> x		1,08	0,90	0,9	1,00	1,00	0,54	0,57	0,69	1,08
Kg x		24,57	18,75	12,00	12,00	12,00	12,00	12,00	12,00	12,00
		40	48	50	55	55	75	64	70	40
m <sup>2</sup> x		43,20	43,20	45,00	55,00	55,00	40,5	36,48	48,30	43,20
Kg x		998	915	615	675	675	915	783	855	495

ANSI A - 137.1: 2012  
WET DYNAMIC COEFFICIENT OF FRICTION | DCOF ≥ 0,42

		on demand		modular system		modular system				Decoro Decorative tile		
		30x60 12"x24" Nat. Ret.	7,5x30 3"x12" Nat. Ret.	15x60 6"x24" Nat. Ret.	15x30 6"x12" Nat. Ret.	15x15 6"x6" Nat. Ret.	10x60 4"x24" Nat. Ret.	10x30 4"x12" Nat. Ret.	10x10 4"x4" Nat. Ret.	30x30 12"x12" Nat. Ret.	30x60 12"x24" Nat. Ret.	
84		I46I84	I46084	I46A84	I46B84	I46C84	I46D84	I46E84	I46F84	I46G84	OPACO 84	I46384
67		I46I67	I46067	I46A67	I46B67	I46C67	I46D67	I46E67	I46F67	I46G67	LUCIDO 84	I46484
29		I46I29	I46029	I46A29	I46B29	I46C29	I46D29	I46E29	I46F29	I46G29	OPACO 90	I46390
14		I46I14	I46014	I46A14	I46B14	I46C14	I46D14	I46E14	I46F14	I46G14	LUCIDO 90	I46690
51		I46I51	I46051	I46A51	I46B51	I46C51	I46D51	I46E51	I46F51	I46G51		
48		I46I48	I46048	I46A48	I46B48	I46C48	I46D48	I46E48	I46F48	I46G48		
08		I46I08	I46008	I46A08	I46B08	I46C08	I46D08	I46E08	I46F08	I46G08		
57		I46I57	I46057	I46A57	I46B57	I46C57	I46D57	I46E57	I46F57	I46G57		
34		I46I34	I46034	I46A34	I46B34	I46C34	I46D34	I46E34	I46F34	I46G34		
PREZZO PRICE		€ 42,00 m <sup>2</sup>	€ 66,00 m <sup>2</sup>	€ 54,00 m <sup>2</sup>	€ 58,00 m <sup>2</sup>	€ 54,00 m <sup>2</sup>	€ 54,00 m <sup>2</sup>	€ 60,00 m <sup>2</sup>	€ 74,00 m <sup>2</sup>	€ 48,00 m <sup>2</sup>	PREZZO PRICE	€ 48,00 m <sup>2</sup>
CODICE PREZZO PRICE CODE		M101	M133	M121	M125	M131	M121	M127	M141	M113	CODICE PREZZO PRICE CODE	M113
Pallet 80x120		Pallet 80x120	Pallet 80x120	Pallet 80x120	Pallet 80x120	Pallet 80x120	Pallet 80x120	Pallet 80x120	Pallet 80x120	Pallet 80x120		Pallet 80x120
IMBALLO cm h. PACKING cm h.		75	75	75	75	75	75	75	75	75	IMBALLO cm h. PACKING cm h.	75
		6	40	10	22	44	9	19	69	12		6
m <sup>2</sup> x		1,08	0,90	0,9	1,00	1,00	0,54	0,57	0,69	1,08	m <sup>2</sup> x	1,08
Kg x		24,57	18,75	12,00	12,00	12,00	12,00	12,00	12,00	12,00	Kg x	24,57
		40	48	50	55	55	75	64	70	40		40
m <sup>2</sup> x		43,20	43,20	45,00	55,00	55,00	40,5	36,48	48,30	43,20	m <sup>2</sup> x	43,20
Kg x		998	915	615	675	675	915	783	855	495	Kg x	998



Civilization of Beauty

# PARTE TECNICA

Technical section . Partie technique . Technischer Teil . Parte técnica . Технический раздел .

<b>OUTDOOR 20 MM</b> .....	376	<b>CARATTERISTICHE TECNICHE</b> .....	400
378 <b>Creare pavimenti senza collanti</b> Create flooring without adhesives Créer des carrelages sans colles Anfertigung von Böden ohne Kleber		Technical features Caracteristiques techniques Technische Eigenschaften Características técnicas Технические характеристики	
380 <b>Un sistema efficace in ogni condizione</b> An effective system in all situations Un système efficace dans toutes conditions Ein in jeder Situation effizientes System		<b>PULIZIA E MANUTENZIONE</b> .....	402
382 <b>Massima resistenza per gli spazi carrabili</b> Hardwearing tiles that are ideal for drive-over areas Résistance maximale pour les espaces carrossables Höchste Beständigkeit für befahrbare Flächen		Product cleaning and maintenance Nettoyage et maintenance du produit Reinigung und Pflege des Produktes Limpieza y mantenimiento Рекомендации по правильной очистке изделия и по уходу за ним	
384 <b>Bellezza e sicurezza per l'area piscina</b> Beauty combined with safety for a perfect pool area Beauté et sécurité pour la zone piscine Schönheit und Sicherheit in Poolbereichen		<b>CONDIZIONI GENERALI DI VENDITA</b> .....	404
386 <b>Outdoor 20 mm: i pezzi speciali</b> 20 mm outdoor option: trims. Extérieur 20 mm : les pièces spéciales Außenbereich 20 mm: die Formteile		General sales terms and conditions Conditions générales de vente Allgemeine Verkaufsbedingungen Condiciones generales de venta Общие условия продажи	
<b>SCHEMI DI POSA</b> .....	392	<b>NOTE GENERICHE SUI PRODOTTI</b> .....	408
Laying sketch Schémas de pose Modulverlegungsbeispiele Esquemas de colocación Схемы укладки		General information on the products Notes générales sur les produits Allgemeine Angaben zu den Produkten Notas generales sobre los productos Общие сведения о продукции	
<b>CHEVRON</b> .....	394	<b>CERTIFICAZIONI</b> .....	409
		Certifications Certifications Zertifikate Certificaciones Сертификация	

# Outdoor 20 mm

Cres porcellanato colorato in massa . Colored body porcelain stoneware . Grès cérame coloré dans la masse . Eingefärbtes Feinsteinzeug

PROGETTARE CON PIASTRELLE DI SPESSORE 20 MM SIGNIFICA UTILIZZARE UN PROGRAMMA DI PAVIMENTAZIONI CON FUNZIONALITÀ EVOLUTE E SPECIFICHE PER L'ESTERNO.

Lo spessore aumentato consente maggiore versatilità di posa e si adatta alla differente natura del letto di fondo sia esso su erba, su ghiaia o su sabbia.

La grande resistenza ai carichi di rottura consente inoltre di realizzare superfici carrabili o pavimentazioni sopraelevate che grazie a specifici supporti rendono possibile l'alloggiamento di impianti elettrici o di irrigazione.

Le caratteristiche delle collezioni di La Fabbrica esprimono tutte le potenzialità estetiche e tecniche sia in ambienti domestici che pubblici.

DESIGNING WITH 20 MM-THICK FLOORING/PAVING TILES MEANS USERS CAN MAKE USE OF A RANGE OF ADVANCED FEATURES DEVISED SPECIFICALLY FOR OUTDOOR USE.

The increased thickness means greater laying versatility and that the material adapts to the various different bases, such as grass, gravel, or sand.

The high ultimate strength also allows users to create driveways or raised floors with specific pedestals and underfloor cavities that can house electrical wiring or irrigation systems.

The characteristics of La Fabbrica's collections cover all the potential design and technical requirements that could be found in both homes and public spaces.

PREVOIR DES CARREAUX DE 20 MM D'ÉPAISSEUR SIGNIFIE UTILISER UN PROGRAMME DE REVÊTEMENT AUX FONCTIONS ÉVOLUÉES ET SPÉCIFIQUES POUR L'EXTÉRIEUR.

Une épaisseur plus importante permet d'obtenir davantage de flexibilité de pose et s'adapte à la nature différente du sol, qu'il s'agisse d'herbe, de gravier ou bien de sable.

La haute résistance aux charges de rupture permet également de réaliser des surfaces carrossables ou des revêtements surélevés qui, grâce à des supports spécifiques, permettent de loger les circuits électriques ou d'irrigation.

Les caractéristiques des collections de La Fabbrica expriment toutes les potentialités esthétiques et techniques si bien dans les espaces domestiques que publics.

MIT 20 MM-PLATTEN FLIESEN, BEDEUTET EIN PROGRAMM AN BODENBELÄGEN ZU VERWENDEN, DAS HOCHENTWICKELTE UND SPEZIELL FÜR AUSSENBEREICHE GEEIGNETE FUNKTIONALITÄTEN AUFWEIST.

Die größere Stärke schafft eine größere Verlegevielseitigkeit und passt sich an die unterschiedlichen Ausführungen des Unterbodens, wie Gras, Kies oder Sand, an.

Aufgrund der hohen Bruchlastfestigkeit können befahrbare Flächen oder Doppelböden geschaffen werden, die dank ihrer besonderen Abstützungen für die Aufnahme von Elektro- oder Berieselungsanlagen geeignet sind.

Die Merkmale der La Fabbrica-Kollektionen entfalten sowohl in Wohnräumen als auch in öffentlichen Umgebungen ihre gesamten ästhetischen und technischen Potentialitäten.

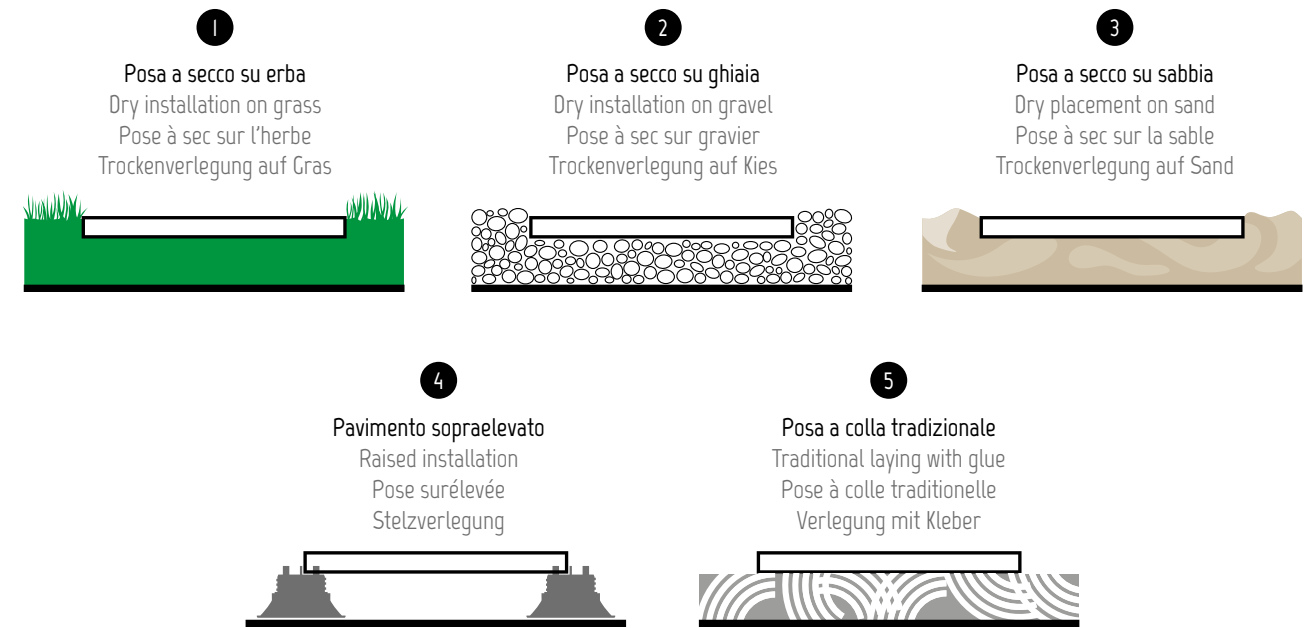

# 20 mm

SPESSORE  
THICKNESS  
ÉPAISSEUR  
STÄRKE

# R11-C

Naturale e rettificato.  
Natural and rectified.  
Naturel et rectifié.  
Natur Oberfläche und kalibriert.



**Non assorbe acqua.**  
No water absorption.  
N'absorbe pas l'eau.  
Nimmt kein Wasser auf.



**Resistente al gelo.**  
Frost resistant.  
Résistant au gel.  
Frostbeständig.



**Resistente agli sbalzi termici.**  
Withstands sudden temperature changes.  
Résistant aux écarts de température.  
Temperaturwechselbeständig.



**Colori inalterabili alla luce del sole.**  
Colourfast even when exposed to sunlight.  
Couleurs inaltérables au soleil.  
Sonnenlichtbeständige, unveränderliche Farben.



**Superficie antiscivolo (R11-C).**  
Non-slip surface (R11-C).  
Surfaces antidérapantes (R11-C).  
Rutschfeste Oberfläche (R11-C).



**Resistente ai carichi di rottura.**  
High ultimate strength.  
Résistant aux charges de rupture.  
Bruchlastbeständig.



**Resistente all'abrasione profonda.**  
Withstands deep abrasion.  
Résistant à l'abrasion profonde.  
Beständig gegenüber Tiefenabrieb.



**Resistente al sale.**  
Salt-proof.  
Résistant au sel.  
Salzbeständig.



**Resistente alle macchie.**  
Stainproof.  
Résistant aux taches.  
Fleckenbeständig.



**Facile da pulire.**  
Easy to clean.  
Facile à nettoyer.  
Einfach zu säubern.



**Resistente ai trattamenti chimici.**  
Withstands chemical treatments.  
Résistant aux traitements chimiques.  
Beständig gegen chemische Behandlungen.



**Resistente alla muffa e al muschio.**  
Withstands mildew and moss.  
Résistant aux moisissures et à la mousse.  
Schimmel- und Moosbeständig.



**Facile da posare.**  
Easy to lay.  
Facile à poser.  
Einfach zu verlegen.



**Facile da sostituire e ispezionare.**  
Easy to replace and access.  
Facile à remplacer et à inspecter.  
Einfach auszuwechseln und zu überprüfen.



**Ignifugo.**  
Flameproof.  
Ignifuge.  
Feuerfest.

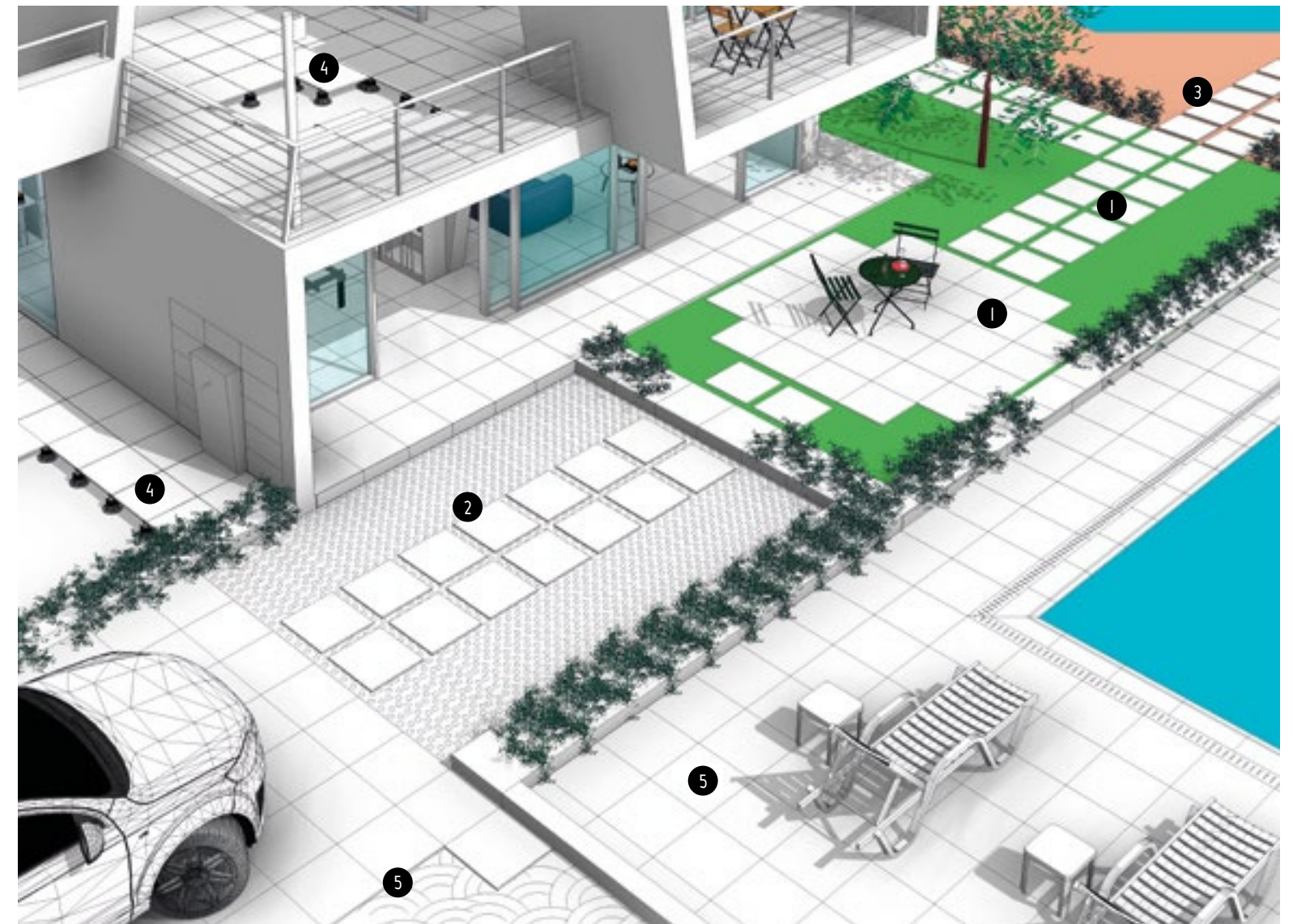

# Creare pavimenti senza collanti

Create flooring without adhesives  
Créer des carrelages sans colles  
Anfertigung von Böden ohne Kleber

Le pose a secco su erba, ghiaia e sabbia si eseguono stendendo le piastrelle direttamente sul fondale senza l'utilizzo di collanti.

Per i camminamenti è più comunemente utilizzata una posa a giunto aperto con una fuga variabile a piacere (A). Superfici destinate a patii, gazebo o zone di riunione dove è prevista la presenza di mobili è consigliabile la posa a giunto unito (B).

Su erba, per ottenere una superficie planare e integrata al livello del manto erboso, si consiglia di scavare il terreno per circa 5 cm e distribuire sul fondale sabbia o ghiaia con granulometria fine per facilitare il livellamento.

The tiles may be dry-laid directly onto grass, gravel or sand without the use of any adhesives.

For walkways, the most common method is an open joint, with the size of the gap varying according to taste (A). For areas intended for patios, gazebos, or meeting areas, where furniture will be placed, we recommend a closed joint (B).

When laying in a lawn area, in order to ensure a flat finish which is level with the lawn, we recommend you remove a 5 cm layer of topsoil and then spread fine grain gravel on top of the laying surface to facilitate levelling.

On réalise la pose à sec sur l'herbe, le gravier et le sable en étalant les carreaux directement sur le fond sans l'utilisation de colle.

Pour les allées, on utilise plus communément une pose à joint ouvert avec un joint réglable à volonté (A). Sur les surfaces destinées à des patios, des gazebos ou des zones de réunion où l'on prévoit la présence de mobilier, on recommande la pose à joint uni (B).

Sur l'herbe, pour obtenir une surface plane et intégrée au niveau de la pelouse, il est conseillé de creuser le terrain sur environ 5 cm et de distribuer sur le fond du sable ou du gravier ayant une granulométrie fine pour faciliter le nivellement.

Bei der Trockenverlegung auf Gras, Kies und Sand wird die Fliesen ohne Verwendung eines Klebers direkt auf den Untergrund gelegt.

Für Wege wird normalerweise eine Verlegung mit offenem Stoß und nach Bedarf variierbarer Fuge verwendet (A). Bei Oberflächen für Atrien, Pavillons oder Versammlungsbereiche, in denen Möbel aufgestellt werden, ist eine fugenlose Verlegung (B) zu empfehlen.

Um bei Verlegung auf Gras eine ebene und in die Grasfläche integrierte Oberfläche zu erzielen, wird empfohlen, den Boden etwa 5 cm tief auszugraben und Sand oder Kies mit feiner Korngröße auf dem Untergrund zu verteilen, um die Planierung zu erleichtern.

POSA A SECCO SU GHIAIA  
Dry installation on gravel  
Pose à sec sur gravier  
Trockenverlegung auf Kies

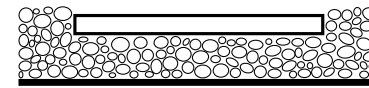

Pierre de Chateaux: Fontainbleau 60x100 (24"x40") 20 mm Nat. Ret. R11

POSA A SECCO SU ERBA  
Dry installation on grass  
Pose à sec sur l'herbe  
Trockenverlegung auf Gras



I Quarzi: Prasio 60x60 (24"x24") 20 mm Nat. Ret. R11

POSA A SECCO SU SABBIA  
Dry placement on sand  
Pose à sec sur la sable  
Trockenverlegung auf Sand



ESEMPIO DI SOLUZIONI PER GLI IMPIANTI BALNEARI.  
EXAMPLE OF BEACH FACILITY DESIGNS.  
EXEMPLE DE SOLUTIONS POUR LES ÉTABLISSEMENTS BALNÉAIRES.  
LÖSUNGSBEISPIELE FÜR STRANDBÄDER.

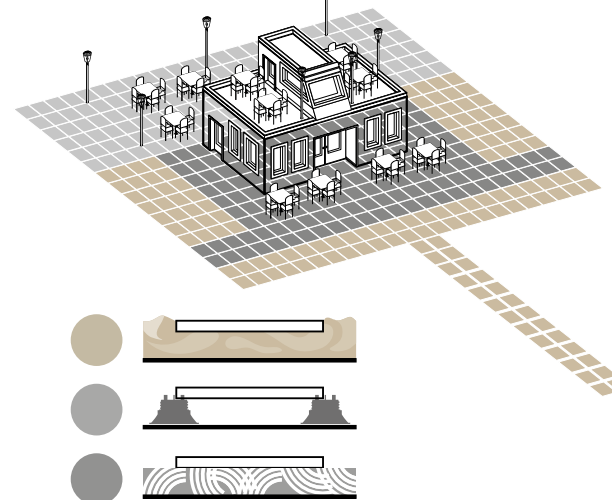

Pierre de Chateaux: Chambord 60x100 (24"x40") 20 mm Nat. Ret. R11



# Un sistema efficace in ogni condizione

An effective system in all situations  
Un système efficace dans toutes conditions  
Ein in jeder Situation effizientes System

## PAVIMENTO SOPRAELEVATO

Raised installation  
Pose surélevée  
Stelzverlegung

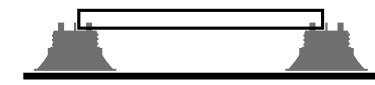

Il sistema sopraelevato di La Fabbrica si basa su tipologie diverse di supporti modulari e regolabili, che con semplicità e sicurezza si adattano ad ogni tipo di fondo per garantire sempre una pavimentazione omogenea ed elegante, senza l'utilizzo di collanti e senza apportare interventi radicali alla struttura preesistente.

The La Fabbrica raised system is based on a range of modular, adjustable pedestals that can be easily and safely adapted to any type of base in order to guarantee a seamless, stylish flooring and paving, without using adhesives or making radical changes to the existing base.

Le système surélevé de La Fabbrica fonctionne avec différents types de plots modulaires et réglables qui, en toute simplicité et sécurité, s'adaptent à n'importe quel type de fond afin de garantir un revêtement homogène et élégant, sans devoir procéder à des interventions radicales à la structure préexistante.

Das Doppelbodensystem von La Fabbrica besteht aus unterschiedlichen modularen und regelbaren Stützen, die sich auf einfache und sichere Weise an jede Unterbodenart anpassen. Damit wird immer ein gleichmäßiger und eleganter Boden garantiert, ohne Verwendung von Klebern und ohne tiefgehende Eingriffe an der bereits vorhandenen Struktur.



## IL SUPPORTO FISSO

FIXED PEDESTALS.  
LE PLOT FIXE.  
FIXHALTERUNG.



## IL SUPPORTO REGOLABILE

ADJUSTABLE PEDESTALS.  
LE PLOT RÉGLABLE.  
REGELBARE STÜTZE.

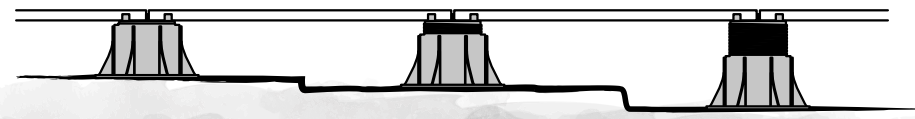

## IL SUPPORTO REGOLABILE AUTOLIVELLANTE

SELF-LEVELLING ADJUSTABLE PEDESTALS.  
LE PLOT RÉGLABLE AUTO-NIVELANT.  
REGELBARE, SELBSTNIVELLIERENDE STÜTZE.

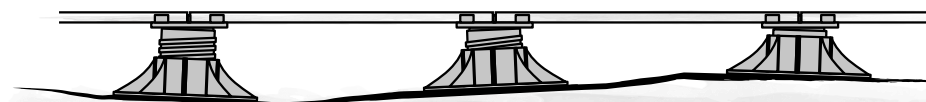

## TECNICA DI POSA PERIMETRALE CON SUPPORTO FISSO.

LAYING AROUND THE PERIMETER USING FIXED PEDESTALS.  
TECHNIQUE DE POSE SUR LE POURTOUR AVEC PLOT FIXE.  
VERLEGETECHNIK DES UMFANGS MIT FIXSTÜTZE.

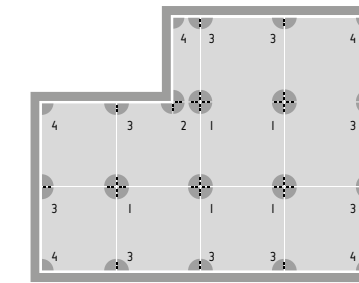
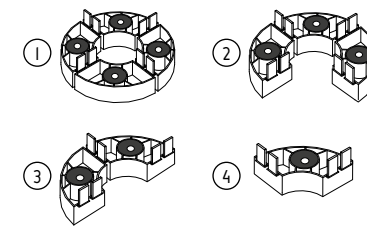

**Tecnica di posa riferita ai formati 60x60, 40x80 e 80x80**  
Laying technique for 60x60, 40x80 and 80x80 sizes  
Technique de pose relative aux formats 60x60, 40x80 et 80x80  
Auf Formate bezogene 60x60, 40x80 und 80x80 Verlegungstechniken

**60x60/40x80/80x80 - Consumo di supporti per m<sup>2</sup>: m<sup>2</sup> pavimentazione x 2,8 + 10%**  
60x60/40x80/80x80 - Pedestals required per m<sup>2</sup>: Sqm flooring/paving x 2,8 + 10%  
60x60/40x80/80x80 - Nombre de plots par m<sup>2</sup>: m<sup>2</sup> de revêtement x 2,8 + 10%  
60x60/40x80/80x80 - Verbrauch an Stützen pro m<sup>2</sup>: m<sup>2</sup> Boden x 2,8 + 10%

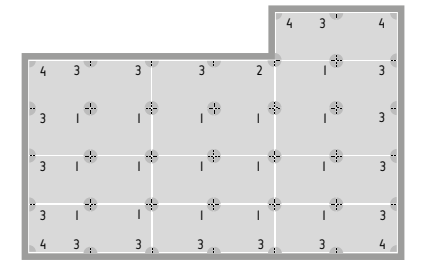

**Tecnica di posa riferita al formato 40x120**  
Laying technique for 40x120 size  
Technique de pose relative au format 40x120  
Auf Format 40x120 bezogene Verlegungstechniken

**40x120 - Consumo di supporti per m<sup>2</sup>: m<sup>2</sup> pavimentazione x 3 + 10%**  
40x120 - Pedestals required per m<sup>2</sup>: Sqm flooring/paving x 3 + 10%  
40x120 - Nombre de plots par m<sup>2</sup>: m<sup>2</sup> de revêtement x 3 + 10%  
40x120 - Verbrauch an Stützen pro m<sup>2</sup>: m<sup>2</sup> Boden x 3 + 10%

## TECNICA DI POSA PERIMETRALE CON SUPPORTO REGOLABILE.

LAYING AROUND THE PERIMETER USING ADJUSTABLE PEDESTALS.  
TECHNIQUE DE POSE DU PÉRIMÈTRE AVEC PLOT RÉGLABLE.  
VERLEGETECHNIK DES UMFANGS MIT REGELBARER STÜTZE.

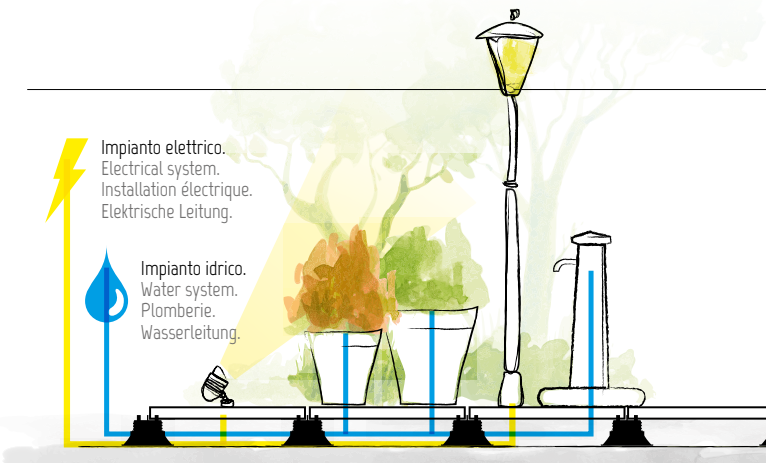
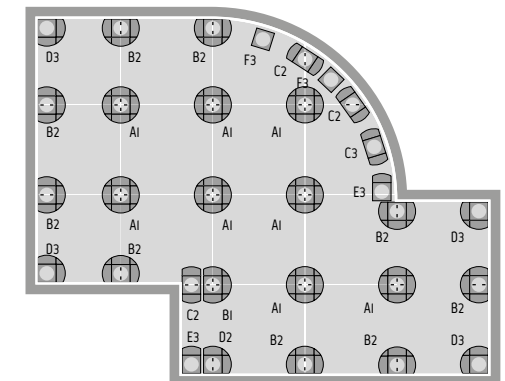
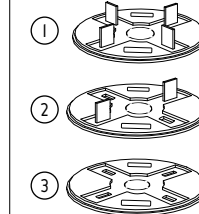
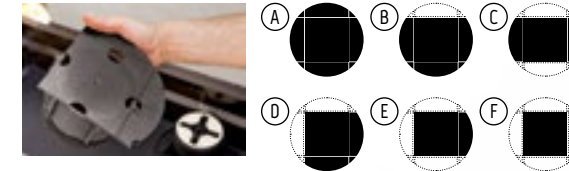

Lo spazio di intercapedine che risulta tra il fondale e la lastra può essere comodamente utilizzato per alloggiare impianti elettrici o idraulici.

The cavity between the base and the flooring/paving can be conveniently used to house wiring or plumbing.

L'espace entre le fond et la dalle peut accueillir sans problèmes les circuits électriques et hydrauliques.

Der Raum zwischen dem Unterboden und der Platte kann bequem zur Unterbringung von elektrischen oder hydraulischen Anlagen.

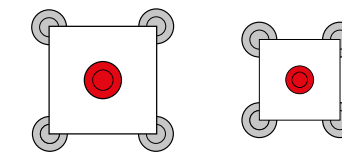
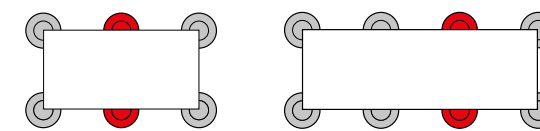

Per garantire il massimo delle prestazioni meccaniche e di sicurezza del pavimento sopraelevato si raccomanda l'uso di un numero superiore di piedini rispetto al minimo necessario (evidenziati in rosso).

To guarantee maximum performance, in terms of mechanical and safety features of the raised floor, we recommend you use more pedestals than the minimum stated (shown in red).

Pour garantir le maximum des performances mécaniques et de sécurité du carrelage surélevé, on recommande d'utiliser un nombre de pieds supérieur au minimum nécessaire (indiqués en rouge).

Zur Garantie der höchsten mechanischen Leistung und Sicherheit des Doppelbodens wird empfohlen, eine höhere Anzahl an Stützen, als die notwendige Mindestmenge (rot gekennzeichnet), zu verwenden.

Si consiglia l'uso di un quinto supporto al centro della piastrella.

We recommend the use of a fifth support at the centre of the tile.

On conseille l'utilisation d'un cinquième support au centre du carreau.

Die Verwendung einer fünften Stütze in der Mitte der Platte wird empfohlen.

# Massima resistenza per gli spazi carrabili

Hardwearing tiles that are ideal for drive-over areas  
Résistance maximale pour les espaces carrossables  
Höchste Beständigkeit für befahrbare Flächen

## POSA A COLLA TRADIZIONALE

Traditional laying with glue  
Pose à colle traditionnelle  
Verlegung mit Kleber



Dall'abbinamento della posa a colla su massetto tradizionale con lo spessore 20 mm delle collezioni "La Fabbrica" derivano una perfetta stabilità del fondo e una eccezionale resistenza ai carichi di rottura.

Ciò permette di realizzare pavimentazioni con elevate prestazioni tecniche ideali per aree sottoposte al passaggio e alla sosta di autoveicoli o per strutture urbane altamente frequentate quali marciapiedi, piste ciclabili o camminamenti pedonali.

The combination of traditional screed laying with adhesive and the 20 mm-thick "La Fabbrica" tiles produces perfect base stability and exceptional ultimate strength.

This allows users to create high-tech paving that is ideal for areas open to vehicle traffic or highly used city facilities, such as pavements, cycle paths, and pedestrian walkways.

L'association de la pose avec colle sur chape traditionnelle avec l'épaisseur de 20 mm des carreaux des collections "La Fabbrica" offre une stabilité parfaite du fond et une résistance exceptionnelle aux charges de rupture.

Cela permet de réaliser des revêtements avec de très hautes performances techniques, idéales pour les zones de passage et de stationnement de véhicules automobiles ou bien pour les structures urbaines très fréquentées telles que les trottoirs, pistes cyclables ou allées piétonnières.

Die Verlegung der 20 mm-Platten der Kollektionen "La Fabbrica" auf traditionellem Estrich unter Verwendung eines Klebers gewährleistet eine perfekte Stabilität des Bodens und eine hervorragende Bruchlastbeständigkeit.

Auf diese Weise können Böden mit hoher technischer Leistung geschaffen werden, die ideal für Begehungsbereiche oder Parkplätze bzw. für städtische Bereiche mit starker Begehung wie Bürgersteige, Fahrrad- oder Fußgängerwege sind.



Quarzi: Prasio 60x60 (24"x24") 20 mm Nat. Ret. R11



Borghii italiani: Cenere 40,6x60,9 (16"x24") - 20,3x40,6 (8"x16") Nat. R11

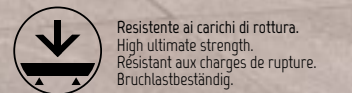

Resistente ai carichi di rottura.  
High ultimate strength.  
Résistant aux charges de rupture.  
Bruchlastbeständig.



Resistente all'abrasione profonda.  
Withstands deep abrasion.  
Résistant à l'abrasion profonde.  
Beständig gegenüber Tiefenabrieb.



# Bellezza e sicurezza per l'area piscina

Beauty combined with safety for a perfect pool area  
 Beauté et sécurité pour la zone piscine  
 Schönheit und Sicherheit in Poolbereichen

# Swimmingpool

Le collezioni di La Fabbrica si rivelano uno strumento raffinato per tutte le progettazioni di spazi esterni, anche le più articolate.

Nella gamma è presente una serie completa di pezzi speciali ottenuti dal fondo 20 mm per risolvere le problematiche legate alle strutture delle piscine e di tutto lo spazio circostante.

La Fabbrica's collections offer designers a sophisticated tool for the creation of even the most complicated of outdoor spaces.

The range includes a complete series of trims, obtained from the 20 mm-thick tiles, designed to solve problems related to swimming pool constructions and the surrounding areas.

Les collections de La Fabbrica s'avèrent un instrument raffiné pour tous les projets d'aménagements d'espaces extérieurs, y compris les plus complexes.

La gamme prévoit une série complète de pièces spéciales obtenues du fond 20 mm pour résoudre les problématiques liées aux structures typiques de la piscine et de tout l'espace autour.

Die Kollektionen von La Fabbrica stellen ein ausserlesenes Instrument für alle, selbst äußerst komplexe Planungsvorhaben von Außenbereichen dar.

Das Programm schließt eine vollständige Serie von Sonderteilen ein, die aus der Serie der 20 mm-Stärke stammen und eigens zur Lösung der typischen Probleme von Pools und ihren umliegenden Bereichen geschaffen wurden.



Amazon: Kamba 40x120 (16"x48") 20 mm Nat. Ret. RII . Gradone Bordo Svasato 40x120 (16"x48") 20 mm Nat. Ret. RII . Griglia 20, 20x60 (8"x24") 20 mm Nat. Ret. RII



GRIGLIA 30

I Quarzi:  
 Madera 60x60 (24"x24") 20 mm Nat. Ret. RII  
 Gradone Bordo Svasato 30x60 (12"x24") 20 mm Nat. Ret. RII  
 Griglia 30, 30x60 (12"x24") 20 mm Nat. Ret. RII

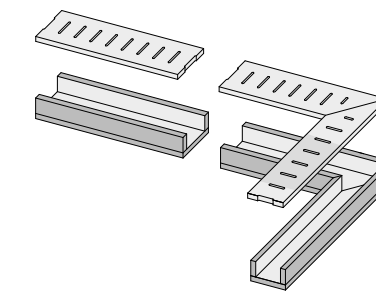
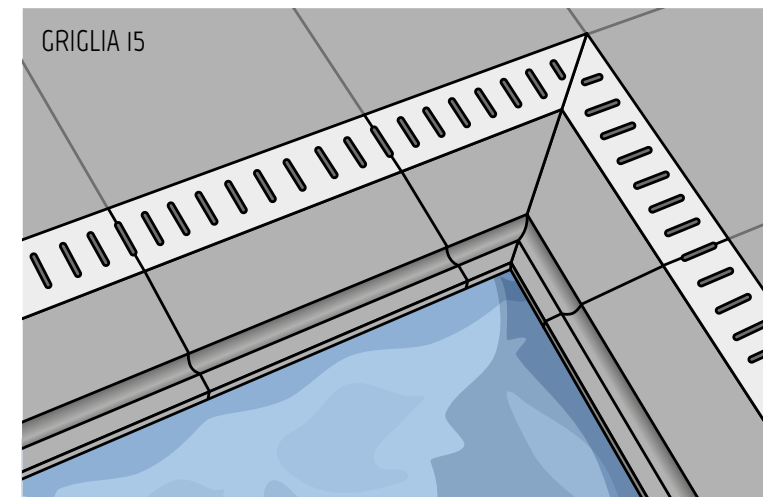

GRIGLIA 15  
 15x60 . 6"x24" 20 mm Nat. Ret. RII  
 CANALINA  
 15x8x60 . 6"x3"x24" 20 mm Nat. Ret. RII

Gradone Bordo Svasato 30x60 (12"x24") 20 mm Nat. Ret. RII  
 Griglia 15, 15x60 (6"x24") 20 mm Nat. Ret. RII

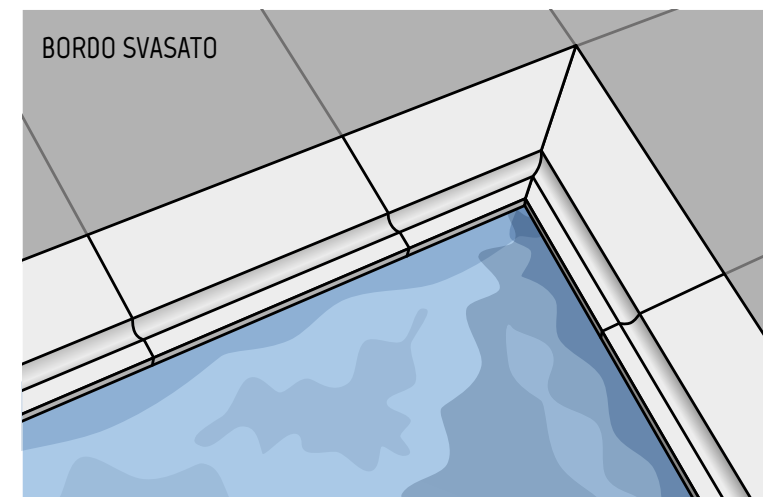

Bordo Svasato 30x60 (12"x24") 20 mm Nat. Ret. RII

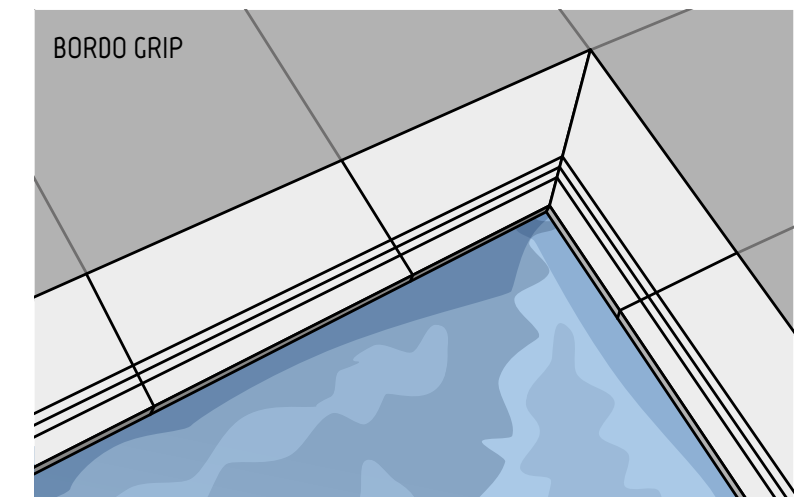

Bordo Grip 30x60 (12"x24") 20 mm Nat. Ret. RII

# Outdoor 20 mm: i pezzi speciali

20 mm outdoor option: trims  
 Extérieur 20 mm : les pièces spéciales  
 Außenbereich 20 mm: die Formteile

## Swimmingpool & Outdoor - RII-C

**GRADONE BORDO** . Large step . Nez de marche avec bord . Stufenplatten . Placa borde . Большая ступень .

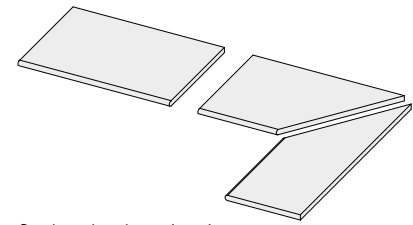

**Gradone bordo 40 / 30 / 15**  
 Large step 40 / 30 / 15  
 Nez de marche avec bord 40 / 30 / 15  
 Stufenplatten 40 / 30 / 15  
 Placa borde 40 / 30 / 15  
 Большая ступень 40 / 30 / 15

40x120 . 16"x48"    30x60 . 12"x24"    15x60 . 6"x24"  
 40x80 . 16"x31 1/2"    CC    CC    CC

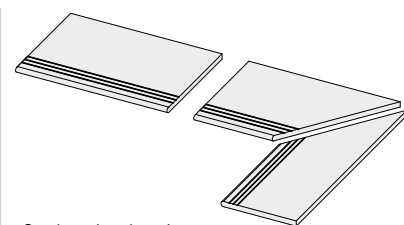

**Gradone bordo grip**  
 Large step with anti-slip border.  
 Nez de marche avec antidérapant.  
 Stufenplatten gerippt.  
 Placa borde antideslizamiento.  
 Большая ступень с нескольким бортом.

40x120 . 16"x48"  
 40x80 . 16"x31 1/2"  
 30x60 . 12"x24"  
 CC    CC

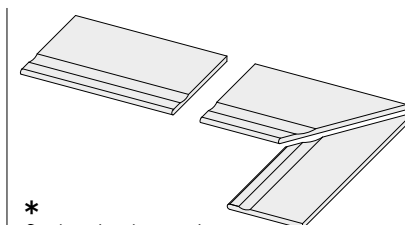

**\* Gradone bordo svasato**  
 Large step with rounded border.  
 Nez de marche bord boudin.  
 Stufenplatten gerippt.  
 Placa borde rebajado.  
 Большая ступень с выемкой.

40x120 . 16"x48"  
 40x80 . 16"x31 1/2"  
 30x60 . 12"x24"  
 CC    CC

## Swimmingpool & Outdoor - RII-C

**GRIGLIE** . Drainage grid . Drainage grille . Rinnenabdeckung . Rejilla . Решетки .

**Griglia 30 / 20 / 15**  
 Drainage grid 30 / 20 / 15  
 Drainage grille 30 / 20 / 15  
 Rinnenabdeckung 30 / 20 / 15  
 Rejilla 30 / 20 / 15  
 Решетка 30 / 20 / 15

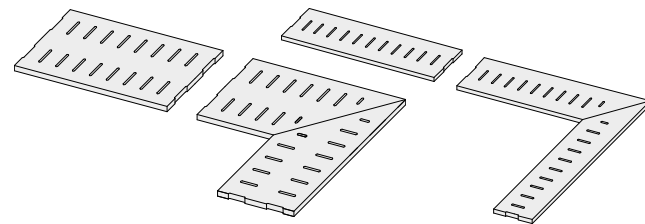

30x60 . 12"x24"    20x60 . 8"x24"    15x60 . 6"x24"  
 20x80 . 8"x31 1/2"

## Swimmingpool & Outdoor - RII-C

**CANALINE** . Channel . Caniveaux . Überlauferinne . Canaleta . Желоба .

**\* Canalina**  
 Channel.  
 Caniveaux.  
 Überlauferinne.  
 Canaleta.  
 Желоб.

20x120x8h . 8"x48"x3"h  
 20x80x8h . 8"x31 1/2"x3"h  
 15x60x8h . 6"x24"x3"h

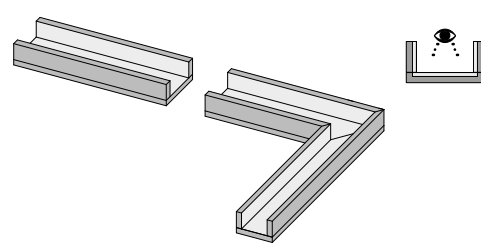

## Outdoor - RII-C

**ALZATE** . Riser . Contremarche . Stoßfläche . Contrahuella . Подступенок .

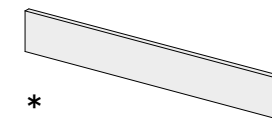

**\* Alzata**  
 Riser.  
 Contremarche.  
 Stoßfläche.  
 Contrahuella.  
 Подступенок.

20x120 . 8"x48"  
 20x80 . 8"x31 1/2"

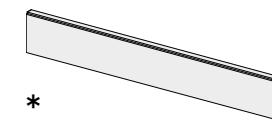

**\* Alzata con scuretto**  
 Riser with shutter.  
 Contremarche avec cannelure.  
 Stoßfläche mit Falzbearbeitung.  
 Contrahuella con banda.  
 Подступенок с вырезом.

20x120 . 8"x48"  
 20x80 . 8"x31 1/2"  
 20x60 . 8"x24"

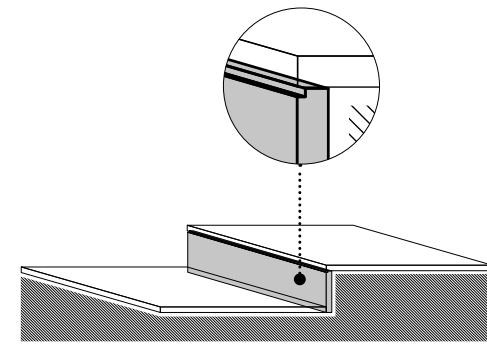

## Outdoor - RII-C

**BORDI** . Border . Bord . Rand . Borde . Борт .

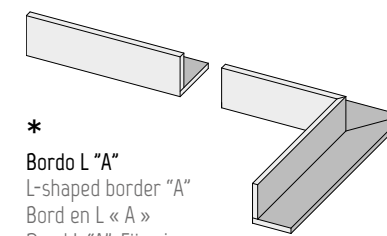

**\* Bordo L "A"**  
 L-shaped border "A"  
 Bord en L « A »  
 Rand L "A"-Förmig  
 Borde L "A"  
 Г-образный борт "К"

10x120x10h . 4"x48"x4"h  
 10x80x10h . 4"x31 1/2"x4"h  
 15x60x15h . 6"x24"x6"h

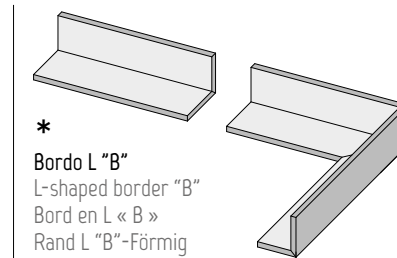
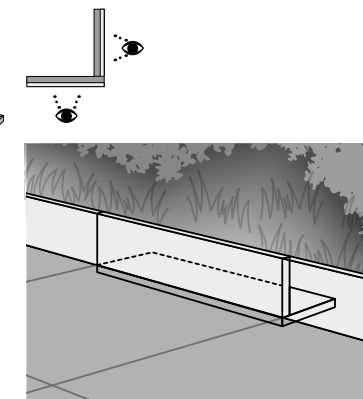

**\* Bordo L "B"**  
 L-shaped border "B"  
 Bord en L « B »  
 Rand L "B"-Förmig  
 Borde L "B"  
 Г-образный борт "Б"

10x120x10h . 4"x48"x4"h  
 10x80x10h . 4"x31 1/2"x4"h  
 15x60x15h . 6"x24"x6"h

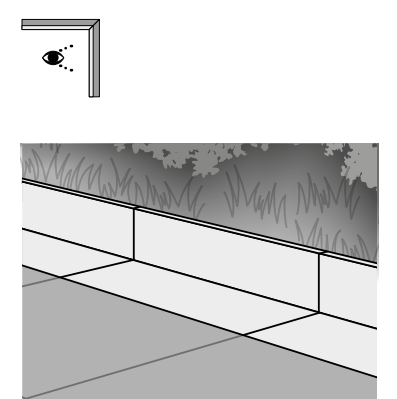

## Outdoor - RII-C

**CORDOLI** . U-Border . Bordure . Rand U-Förmig . Bordillo . Бордюор .

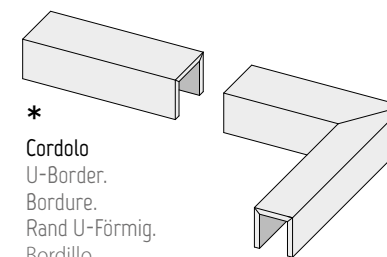

**\* Cordolo**  
 U-Border.  
 Bordure.  
 Rand U-Förmig.  
 Bordillo.  
 Бордюор.

13x120x13h . 5"x48"x5"h  
 13x80x13h . 5"x31 1/2"x5"h  
 15x60x15h . 6"x24"x6"h

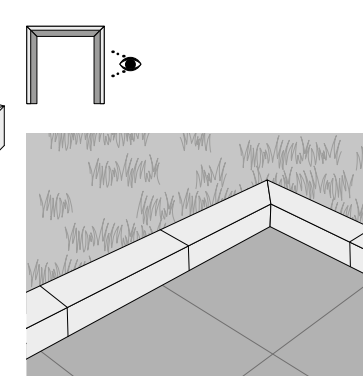

**\* PEZZI SPECIALI** - A disposizione solo su richiesta. Tempi di consegna: 30gg.

TRIMS - Available upon request only. Delivery terms: 30 days.

PIÈCES SPECIALES - Disponible seulement sur requête. Délais de livraison: 30 jours.

FORMSTÜCKE - Verfügbar auf Anfrage. Lieferzeit: 30 Tage.

PIEZAS ESPECIALES - Disponible sólo bajo pedido. Plazo de entrega: 30 días.

СПЕЦИАЛЬНЫЕ ЭЛЕМЕНТЫ - Изготавливается только по специальной заявке. Срок поставки: 30 дней.

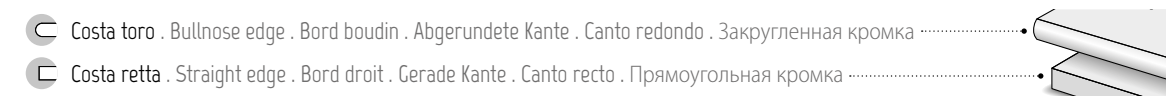

Costa toro . Bullnose edge . Bord boudin . Abgerundete Kante . Canto redondo . Закругленная кромка  
 Costa retta . Straight edge . Bord droit . Gerade Kante . Canto recto . Прямоугольная кромка

## Outdoor - RII-C

**TOP GOCCIOLATOIO** . Drip cap . Plaque supérieure égouttement .  
Zufälliger grafischer Entwurf (Technologie mit Rolle) . Top canalón . Одинарная верхняя плита .

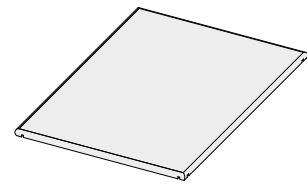

**\* Top gocciolatoio passante**  
Flow-through drip cap.  
Dessus égouttoir passant.  
Top mit durchgehender Wassernase.  
Top canalón pasante.  
Одинарная верхняя плита с отливом

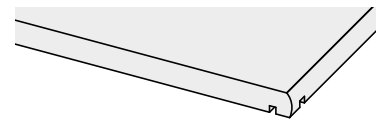

50x50 . 20"x20"  
40x40 . 16"x16"

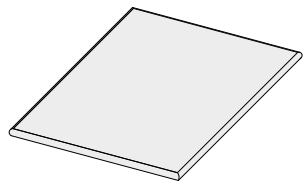

**\* Top gocciolatoio non passante**  
Non-flow-through drip cap.  
Dessus égouttoir non passant.  
Top ohne durchgehender Wassernase.  
Top canalón no pasante.  
Одинарная верхняя плита без отлива

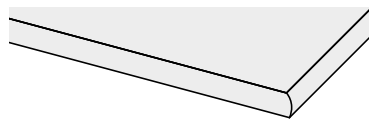

50x50 . 20"x20"  
40x40 . 16"x16"

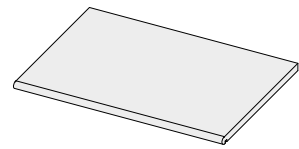

**\* Copertina / Gocciolatoio singolo**  
Cover / single drip cap.  
Couverture / unique égouttoir.  
Abdeckplatte mit Wassernase.  
Cubierta/Canalón singular.  
Верхняя плита с одним отливом

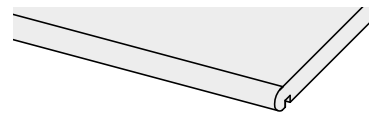

30x60 . 12"x24"

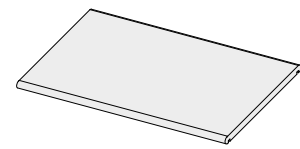

**\* Copertina / Gocciolatoio doppio**  
Cover / double drip cap  
Couverture / double égouttoir  
Abdeckplatte mit Wassernase doppelt  
Cubierta/Canalón doble.  
Верхняя плита с двумя отливами

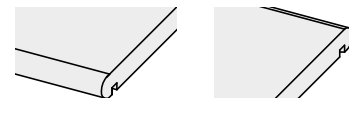

30x60 . 12"x24"

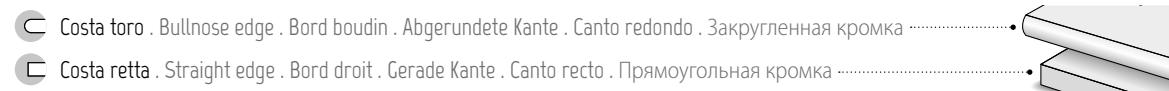
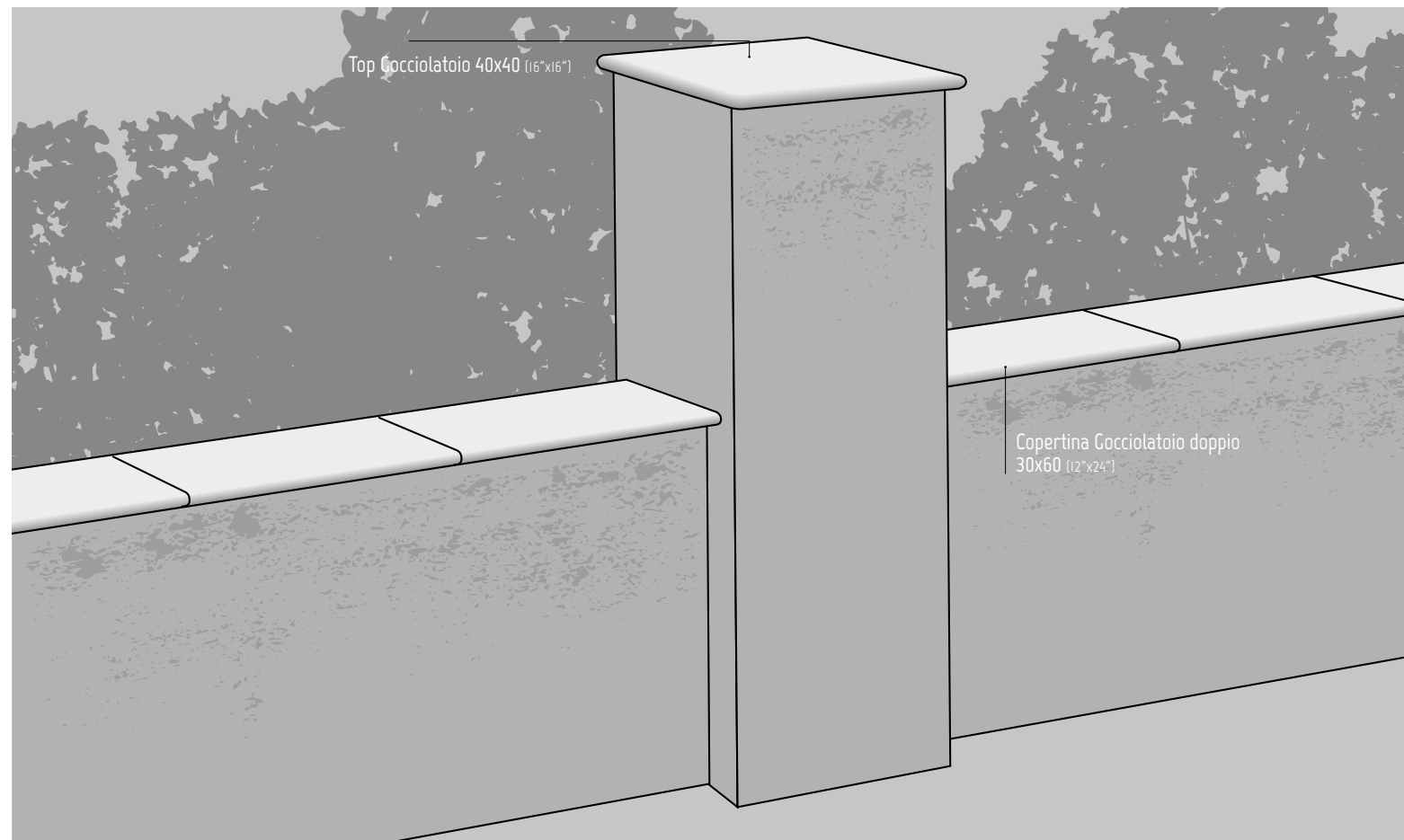

## Outdoor - RII-C

**PER BORDURE E AIUOLE** . For borders and flower beds . Pour bordures et parterres .  
Für Borde und Rabatten . Para bordes y parterres . Для бордюров и клумб .

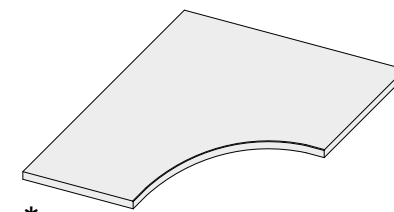

**\* Angolo curvilineo 30**  
Curve-shaped corner 30  
Angle arrondi 30  
Innenecke 30  
Ángulo curvilíneo 30  
Закругленный угол 30

60x60 . 24"x24"

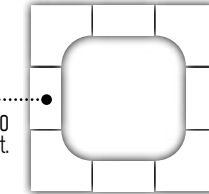
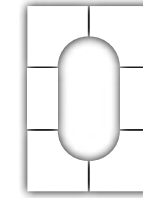
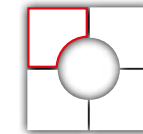

GRADONE BORDO 30  
30x60 . 12"x24" Nat. Ret.

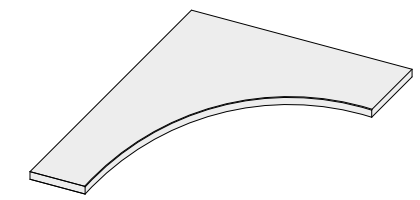

**\* Angolo curvilineo 15**  
Curve-shaped corner 15  
Angle arrondi 15  
Innenecke 15  
Ángulo curvilíneo 15  
Закругленный угол 15

60x60 . 24"x24"

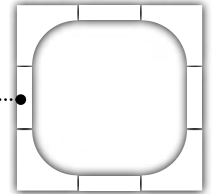
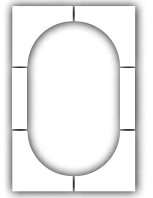
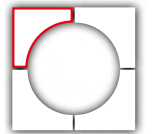

GRADONE BORDO 15  
15x60 . 6"x24" Nat. Ret.



I Quarzi:  
Prasio 60x60 (24"x24") 20 mm Nat. Ret. RII  
Prasio Angolo Curvilineo 15, 60x60 (24"x24") 20 mm Nat. Ret. RII

**\* PEZZI SPECIALI** - A disposizione solo su richiesta. Tempi di consegna: 30gg.  
TRIMS - Available upon request only. Delivery terms: 30 days.  
PIÈCES SPECIALES - Disponible seulement sur requête. Délais de livraison: 30 jours.  
FORMSTÜCKE - Verfügbar auf Anfrage. Lieferzeit: 30 Tage.  
PIEZAS ESPECIALES - Disponible sólo bajo pedido. Plazo de entrega: 30 días.  
СПЕЦИАЛЬНЫЕ ЭЛЕМЕНТЫ - Изготавливается только по специальной заявке. Срок поставки: 30 дней.

**IL SUPPORTO FISSO . Fixed pedestals . Le plot fixe . Fixhalterung .**



**Il supporto fisso I5**  
Fixed pedestals I5  
Le plot fixe I5  
Fixhalterung I5

**P009 = 4pcs**



**Spessore-livellatore in gomma**  
Rubber levelling shims

3 mm - Ø 110 mm

**P009 = 4pcs**



**Spessore-livellatore in gomma**  
Rubber levelling shims

2 mm - Ø 110 mm

**P009 = 4pcs**

**IL SUPPORTO REGOLABILE . Self-levelling adjustable pedestals . Le plot réglable auto-nivelant . Regelbare, selbstnivellierende Stütze.**



**P025 mm 25 / 40**



**P027 mm 40 / 70**



**P029 mm 60 / 100**



**P033 mm 90 / 160**

**IL SUPPORTO REGOLABILE AUTOLIVELLANTE**

Self-levelling adjustable pedestals . Le plot réglable auto-nivelant . Regelbare, selbstnivellierende Stütze .



**P033 mm 28 / 38**



**P037 mm 37,5 / 50**



**P039 mm 50 / 75**



**P041 mm 75 / 120**



**P043 mm 120 / 170**



**Clip universale per bordo piastra**  
Universal edge clip

**P043**



**Chiave di regolazione**  
Adjustment key

**P187**

EUROPALLET 80x120 cm

PZ. X SCAT. Pieces x Box Stk. x Krt. Pcs / Bte	MQ. X SCAT. Sqm x Box Qm x Krt. M2/ Bte	KG X SCAT. Weight x Box Gewicht x Krt. (kg) Poids / Bte (kg)	SCAT. X PAL. Boxes x Pal. Krt. x Pal. Bte / Pal.	MQ. X PAL. Sqm x Pal. Qm x Pal. M2 / Pal.	KG X PAL. Weight x Pal. Gewicht x Pal (kg) Poids / Pal. (kg)	Cm. h Pal.

**SUPPORTO FISSO I5 . Fixed I5 pedestals . Le plot fixe I5 . Fixhalterung I5.**

Supporto I5 fisso	200	-	10,00	20	-	-	-
Livellatore in gomma 3 mm	500	-	12,00	70	-	-	-
Livellatore in gomma 2 mm	600	-	10,20	70	-	-	-

**SUPPORTO REGOLABILE . Adjustable pedestals . Plot réglable . Regelbare Stütze .**

Supporto regolabile mm 25/40	30	-	6,39	42	-	-	-
Supporto regolabile mm 40/70	35	-	9,28	30	-	-	-
Supporto regolabile mm 60/100	25	-	8,63	30	-	-	-
Supporto regolabile mm 90/160	20	-	8,42	30	-	-	-

**SUPPORTO REGOLABILE AUTOLIVELLANTE . Self-levelling adjustable pedestals . Plot réglable auto-nivelant . Regelbare, selbstnivellierende Stütze.**

Supporto regolabile autolivellante 28/38	50	-	13,15	30	-	-	-
Supporto regolabile autolivellante 37,5/50	40	-	14,40	30	-	-	-
Supporto regolabile autolivellante 50/75	30	-	10,65	30	-	-	-
Supporto regolabile autolivellante 75/120	30	-	13,80	20	-	-	-
Supporto regolabile autolivellante 120/170	25	-	13,13	20	-	-	-
Chiave di regolazione	1	-	0,10	-	-	-	-
Clip universale per bordo piastra	-	-	-	-	-	-	-

**ATTENZIONE:** Per particolari installazioni potrebbero essere necessari articoli ed accessori specifici non presenti in questo catalogo. Per queste esigenze prego riferirsi direttamente al referente commerciale La Fabbrica.

N.B. Particular items and accessories not listed in this catalogue may be required for certain laying methods. For these needs, please contact the La Fabbrica sales directly.

ATTENTION : Pour les installations particulières, certains articles et accessoires particuliers qui ne sont pas indiqués dans ce catalogue pourraient être nécessaires. Dans ces cas-là, nous vous prions de vous référer directement à la référence commerciale La Fabbrica.

ACHTUNG: Für besondere Installationen können besondere Artikel oder Sonderzubehör notwendig sein, die nicht im vorliegenden Katalog aufgeführt sind. Wenden Sie sich bitte in diesen Fällen direkt an den Vertrieb von La Fabbrica.

ATENCIÓN: para instalaciones particulares podrían requerirse artículos y accesorios específicos que no están presentes en este catálogo. Para tales casos rogamos contactar directamente al representante comercial de La Fabbrica.

ВНИМАНИЕ: Для особых применений могут быть необходимы специальные артикулы и аксессуары, не представленные в данном каталоге. По поводу этих вопросов просим вас обращаться непосредственно к менеджеру коммерческого отдела компании La Fabbrica.

Il peso dei PEZZI SPECIALI 20 mm indicato in tabella si riferisce al peso del singolo pezzo.

Per calcolare il peso complessivo del materiale imballato occorrerà aggiungere al peso in tabella il peso dell'imballo e della paletta (peso variabile da 10 a 30 kg in funzione della quantità e della tipologia dei PEZZI SPECIALI richiesti).

The weight of the 20 mm TRIMS stated in the table refers to the weight of each trim.

To calculate the total weight of the packed material, you will need to add the combined weight of the packing materials and the pallet (weight ranging from 10 to 30 kg depending on the quantity and the type of the trims required) to the weight stated in the table.

Le poids des PIECES SPECIALES 20 mm indique dans le tableau se réfère au poids individuel de chaque pièce.

Pour calculer le poids total du matériel emballé, il faudra ajouter au poids indique dans le tableau le poids de l'emballage et de la palette (poids variable de 10 a 30 kg en fonction de la quantité et du type de PIECES SPECIALES demandées).

Das in der Tabelle angegebene Gewicht der 20 mm-SONDERTEILE bezieht sich auf das Gewicht des Einzelteils.

Zur Berechnung des Gesamtgewichts des verpackten Materials muss zum in der Tabelle aufgeführten Wert das Gewicht der Verpackung und der Palette (von 10 bis 30 kg variierbar in Abhängigkeit von der Menge und Art der gewünschten SONDERTEILE) dazugerechnet werden.

# Schemi di posa

Laying sketch . Schémas de pose .  
Modulverlegungsbeispiele . Esquemas de colocación .  
Схемы укладки .

Si consiglia di mantenere una fuga di 2 mm per la posa in monofornato degli articoli rettificati.

Si consiglia di mantenere una fuga di 3 mm per la posa in multiformato (da 2 formati e oltre) degli articoli rettificati.

Si consiglia di mantenere una fuga di 4 mm per la posa degli articoli con bordi non rettificati.

If you are laying same sized straightened-edged tiles, we recommend you keep a 2 mm joint.

If you are laying different sized straightened-edged tiles (two or more sizes) together, we recommend you keep a 3 mm joint.

In the case of non-straightened-edged tiles, we recommend you keep a 4 mm joint.

On conseil de préserver un joint de 2 mm pour la pose en mon format des articles rectifiés.

On conseil de préserver un joint de 3 mm pour la pose en multiformat (de 2 formats et plus) des articles rectifiés.

On conseil de préserver un joint de 4 mm pour la pose des articles présentant des bords non rectifiés.

Es wird geraten, eine Fuge von 2 mm bei der Verlegung der geschliffenen Artikel im Einzelformat einzuhalten.

Es wird geraten, eine Fuge von 3 mm bei der Verlegung der geschliffenen Artikel als Multiformat (2 Formate und mehr) einzuhalten.

Es wird geraten, eine Fuge von 4 mm bei der Verlegung der Artikel mit ungeschliffenen Rändern einzuhalten.

Se aconseja mantener una junta de 2 mm para la colocación en monofornato de los artículos rectificados.

Se aconseja mantener una junta de 3 mm para la colocación en multiformato (de 2 y más formatos) de los artículos rectificados.

Se aconseja mantener una junta de 4 mm para la colocación de los artículos con bordes no rectificados.

Рекомендуем оставлять межплиточный шов 2 мм при укладке обрезных изделий только одного формата.

Рекомендуем оставлять межплиточный шов 3 мм при укладке обрезных изделий нескольких (2 или более) форматов.

Рекомендуем оставлять межплиточный шов 4 мм при укладке изделий с необрезными кромками.

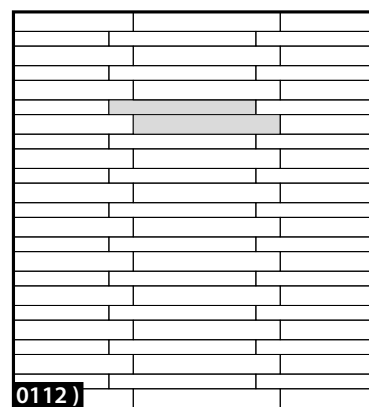

**0112**  
12x96,2=42,9%  
16x96,2=57,1%  
16x96,2=40%  
24x96,2=60%

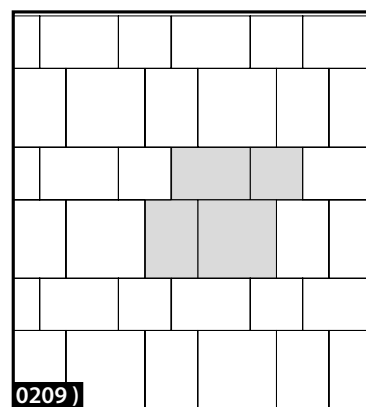

**0209**  
30x45=48%  
45x45=36%  
30x30=16%

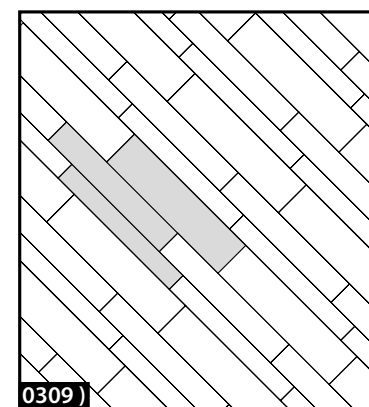

**0309**  
24x96,2=46%  
16x96,2=31%  
12x96,2=23%

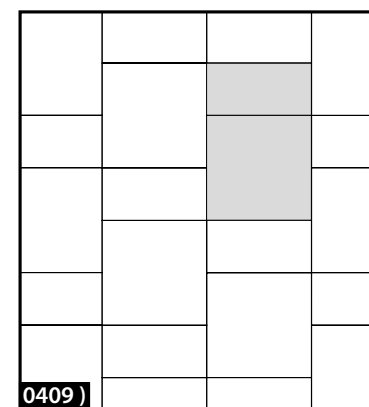

**0409**  
60x60=66,7%  
30x60=33,3%

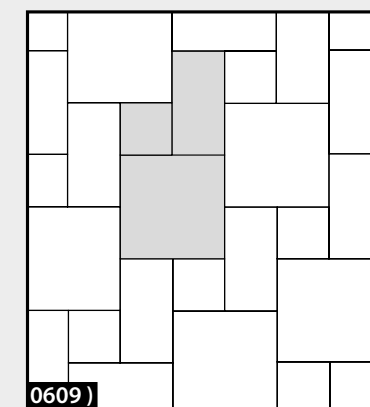

**0609**  
15x15=14,3%  
15x30=28,6%  
30x30=57,1%

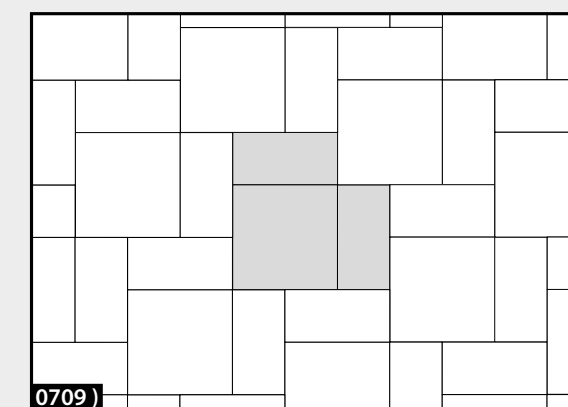

**0709**  
60x60=50,0%  
30x60=50,0%  
30x30=50,0%  
15x30=50,0%

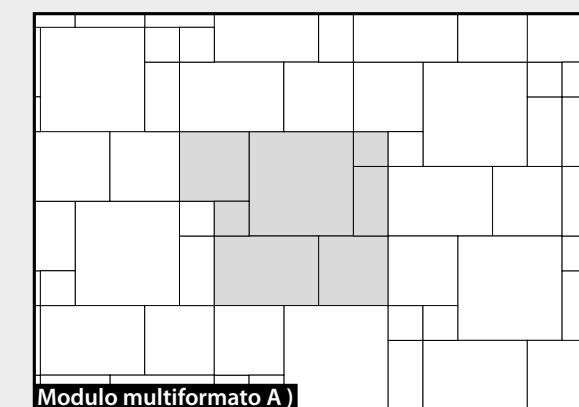

**Modulo multiformato A)**  
60,9x60,9=33,0%  
20,3x40,6=7,5%  
40,6x60,9=22,3%  
20,3x20,3=7,5%  
40,6x40,6=29,7%

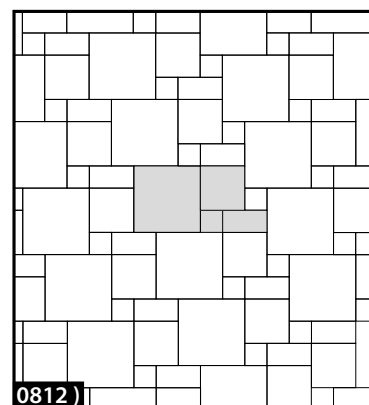

**0812**  
45x45=56,3%  
15x30=12,5%  
15x15=6,2%  
30x30=25%

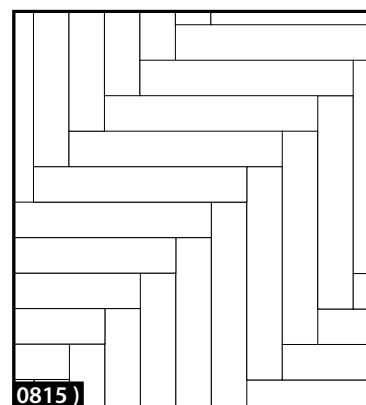

**0815**  
20x120=100%

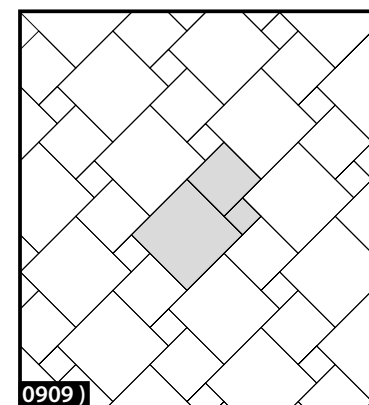

**0909**  
15x15=7,2%  
30x30=28,6%  
45x45=64,2%

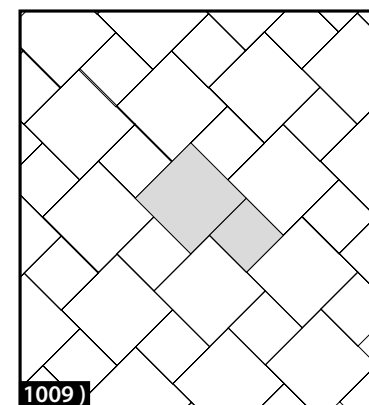

**1009**  
45x45=69,2%  
30x30=30,8%

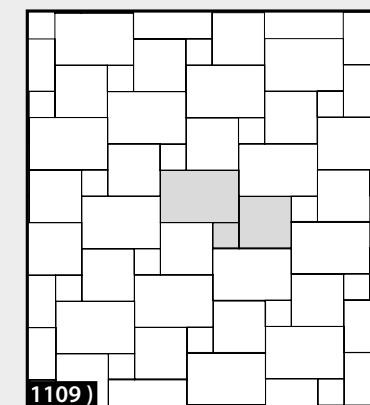

**1109**  
30x45=54,6%  
30x30=36,4%  
15x15=9%

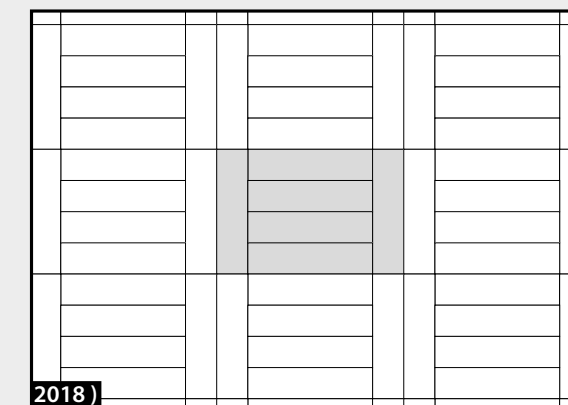

**2018**  
30x120=100%

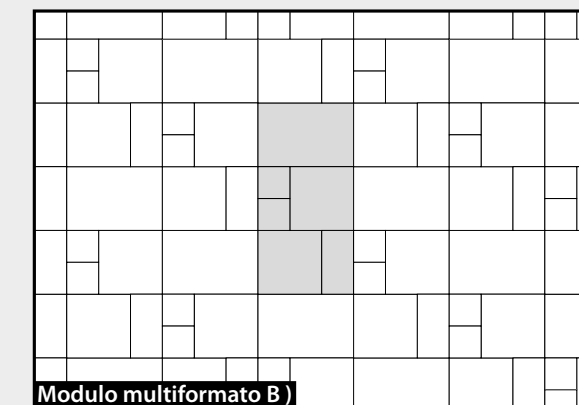

**Modulo multiformato B)**  
40,6x60,9=33,3%  
20,3x40,6=11,1%  
40,6x40,6=44,5%  
20,3x20,3=11,1%

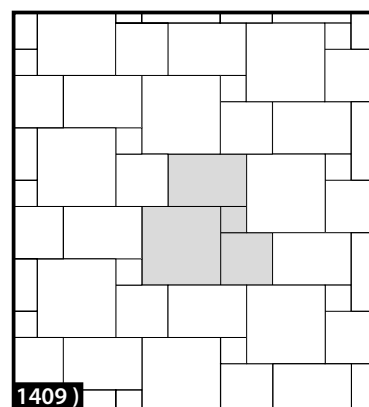

**1409**  
15x15=5%  
30x30=19,9%  
30x45=30%  
45x45=45,1%

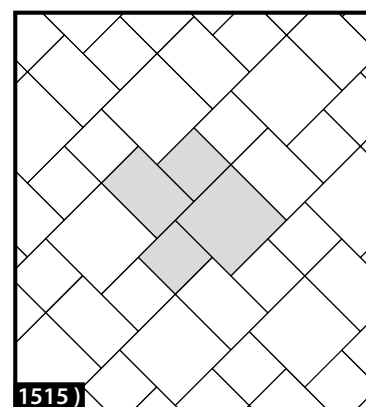

**1515**  
45x45=39,1%  
30x30=34,8%  
30x45=26,1%

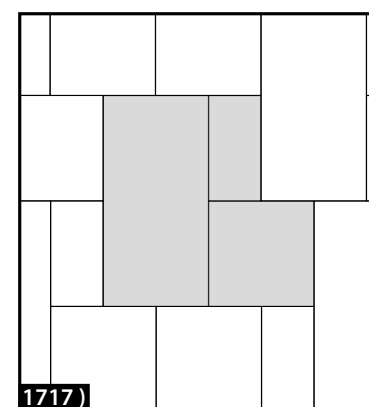

**1717**  
120x60=57%  
60x60=29%  
60x30=14%

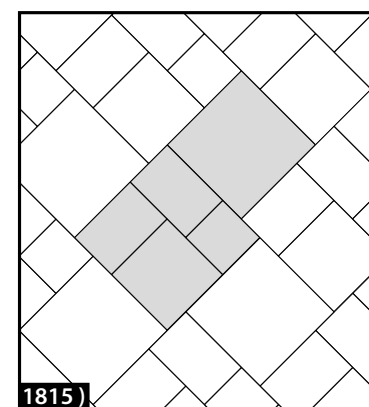

**1815**  
60,5x60,5=39,4%  
45x45=21,8%  
30x45=29,0%  
30x30=9,8%

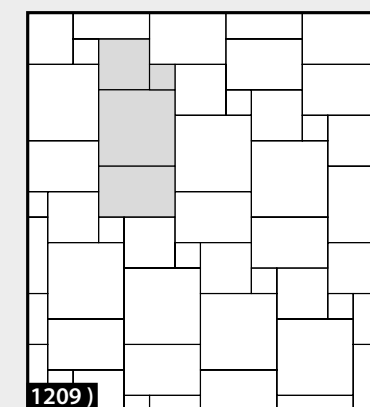

**1209**  
15x15=5%  
30x45=30%  
30x30=19,9%  
45x45=45,1%

# Chevron

Il formato 7,5x40,7 cm combinato al listello 7,5x45 cm permette la creazione di diverse pose, adatte sia a pavimento che a rivestimento, arricchendo gli ambienti di un design artigianale.

The 7.5x40.7 cm tiles combined with the 7.5x45 cm strip allows the creation of different designs, which are suitable for both floors and walls, lending rooms an artisan-like finish.

Le format 7,5x40,7 cm combiné au listel de 7,5x45 cm permet de créer différentes poses, adaptées aussi bien aux carrelages de sol qu'aux revêtements muraux, pour enrichir les espaces avec un design artisanal.

Das Format 7,5x40,7 cm ermöglicht, kombiniert mit der Leiste 7,5x45 cm, die Erstellung verschiedener Verlegungsarten, die sich sowohl für den Boden- als auch für den Wandbelag eignen und die Räume durch ein handwerkliches Design bereichern.

El formato 7,5 x 40,7cm combinado con la plaqueta 7,5 x 45 cm permite la creación de variadas formas de colocación, adecuadas tanto para pavimentos como para paredes, enriqueciendo los ambientes con un diseño artesanal.

Формат 7,5x40,7 см в сочетании с бордюром 7,5x45 см позволяет выполнять различные виды укладки, пригодные как для настила полов, так и для облицовки стен, наполняя пространства ремесленным дизайном.

## AVVERTENZE PER LA POSA.

LAYING WARNINGS.  
AVERTISSEMENTS POUR LA POSE.  
HINWEISE FÜR DIE VERLEGUNG.  
ADVERTENCIAS PARA LA COLOCACIÓN.  
ПРЕДУПРЕЖДЕНИЯ ПО УКЛАДКЕ.

Prima della posa controllare tonalità, calibro e scelta.  
Si consiglia di prelevare piastrelle alternativamente da più scatole.  
Non si accettano reclami relativi a materiale già posato.

Before laying, check the colour tones, work size, and quality category.  
It is advisable to take tiles from multiple boxes alternately.  
No claims will be entered into for laid tiles.

Avant la pose, vérifier la teinte, le calibre et le choix.  
Il est recommandé de prélever des carreaux en alternance dans plusieurs boîtes.  
Les réclamations concernant le matériel déjà posé ne sont pas admises.

Prüfen Sie vor der Verlegung Farbton, Dicke und Qualität.  
Es wird geraten, die Fliesen abwechselnd aus mehreren Kartons zu entnehmen.  
Reklamationen bezüglich bereits verlegtem Material werden nicht angenommen.

Antes de la colocación controlar tonalidad, calibre y selección.  
Se aconseja tomar baldosas alternativamente desde varias cajas.  
No se aceptan reclamos respecto de material ya colocado.

Перед укладкой проверьте тон, калибр и сорт материала.  
Рекомендуется забирать плитку поочередно из разных коробок.  
Претензии по уже уложенному материалу не принимаются.

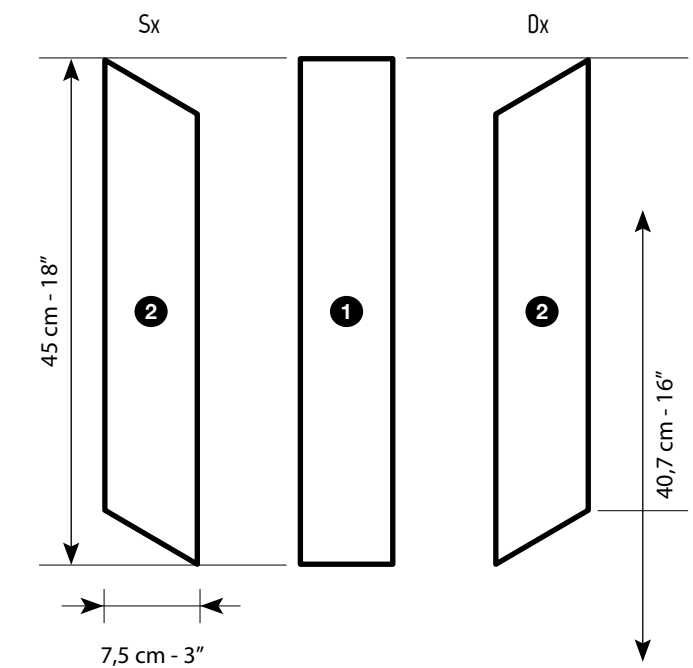

- 1**  
Listello 7,5x45 cm . 3"x18"  
Spessore. Thickness. Epaisseur. Stärke. Espesor . Толщина  
10 mm
- 2**  
Chevron 7,5x40,7 cm . 3"x16"  
Spessore. Thickness. Epaisseur. Stärke. Espesor . Толщина  
10 mm

## POSA CHEVRON SEMPLICE

BASIC CHEVRON DESIGN  
POSE EN CHEVRON SIMPLE  
EINFACHE CHEVRON-VERLEGUNG  
COLOCACIÓN CHEVRON SIMPLE  
ПРОСТАЯ УКЛАДКА В ЕЛОЧКУ

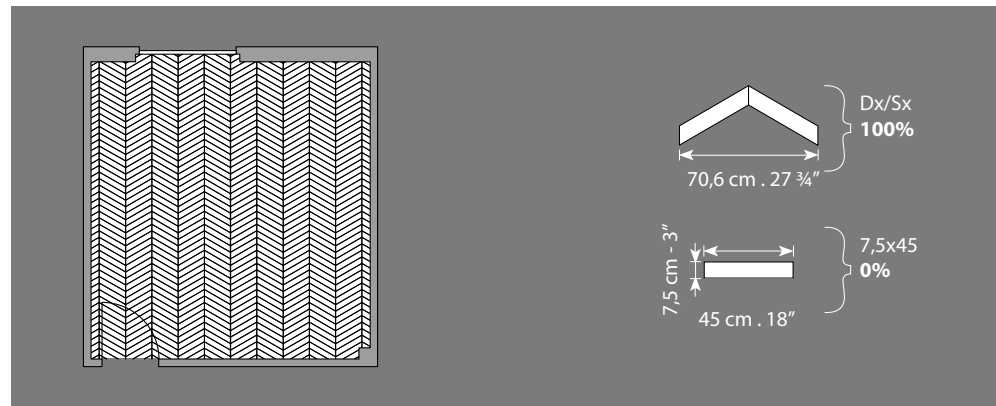

1

Misurare con precisione la larghezza dell'ambiente e tracciare una linea in corrispondenza della mezzeria, come illustrato.

Carefully measure the width of the room and draw the centre line, as shown.

Mesurer la largeur de la pièce avec précision et tracer une ligne au centre d'après l'illustration.

Messen Sie genau die Breite des Raumes und markieren Sie, wie gezeigt, die Mittellinie.

Medir con precisión la anchura del ambiente y trazar una línea en la mitad, tal como se muestra en la ilustración.

Точно измерьте ширину помещения и начертите линию по середине, как показано.

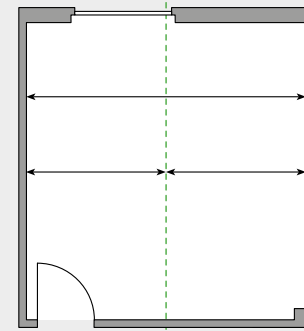

2

Posare il primo Chevron come illustrato. Utilizzare una staggia adeguatamente posizionata come guida. Proseguire la posa fino a terminare la sezione lasciando uno spazio libero per la via d'uscita.

Lay the first chevron as illustrated. Place a levelling bar in position and use as a guide. Keep on laying until you reach the end of the section, leaving room to leave through.

Poser le premier Chevron d'après l'illustration. Utiliser une règle correctement positionnée servant de guide. Poursuivre la pose jusqu'à ce que la section soit terminée en laissant un espace libre pour pouvoir sortir.

Verlegen Sie, wie gezeigt, das erste Chevron. Verwenden Sie ein angemessen positioniertes Zieheisen als Führung. Setzen Sie die Verlegung bis zum Ende des Abschnitts fort und lassen Sie einen Freiraum als Ausgang.

Colocar el primer Chevron de la manera ilustrada. Utilizar una regla adecuadamente posicionada como guía. Proseguir realizando la colocación hasta terminar la sección, dejando un espacio libre para la vía de salida.

Уложите первую елочку, как показано. Используйте правильно уложенную рейку в качестве направляющей. Продолжите укладку вплоть до завершения участка, оставив свободное пространство для выхода.

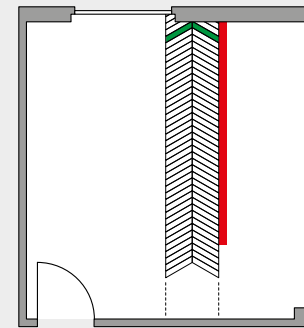

**Inizio posa Chevron** . Start chevron laying . Début de pose Chevron . Beginn der Chevron-Verlegung . Inicio de colocación Chevron . Начало укладки елочку .  
**Staggia** . Levelling bar . Barre . Zieheisen . Regla . Рейка .

3

Completare la posa della prima metà della stanza, posando una sezione alla volta, sempre con l'aiuto di una staggia adeguatamente posizionata.

Finish laying the first half of the room, laying one section at a time, using a suitably positioned levelling bar.

Terminer l'installation de la première moitié de la pièce, en posant une section à la fois, toujours à l'aide d'une règle correctement positionnée.

Kompletieren Sie die Verlegung in der ersten Hälfte des Zimmers, indem Sie jeweils einen Abschnitt mithilfe eines entsprechend positionierten Zieheisens verlegen.

Completar la colocación de la primera mitad de la habitación, instalando una sección por vez, siempre con la ayuda de una regla adecuadamente posicionada.

Завершите укладку первой половины помещения, укладывая один участок за раз, всегда используя правильно уложенную рейку.

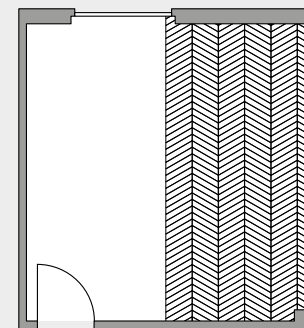

4

Con le stesse modalità, terminare la posa dell'ambiente.

Proceeding in this fashion, finish laying the room.

Terminer la pose du carrelage dans la pièce en suivant les mêmes modalités.

Stellen Sie mit der gleichen Vorgehensweise die Verlegung im Raum fertig.

Proceder de la misma manera para terminar la colocación en la habitación.

Этим же методом завершите укладку во всем помещении.

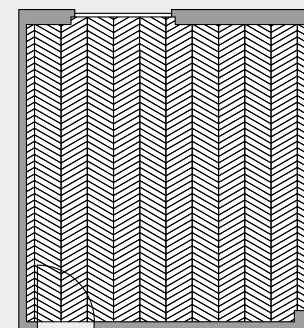

## POSA CHEVRON CON TAPPETO

CHEVRON DESIGN WITH RUG EFFECT  
POSE EN CHEVRON AVEC TAPIS  
CHEVRON-VERLEGUNG MIT TEPPICH  
COLOCACIÓN DE CHEVRON CON ALFOMBRA  
УКЛАДКА В ЕЛОЧКУ С ЭФФЕКТОМ КОВРА

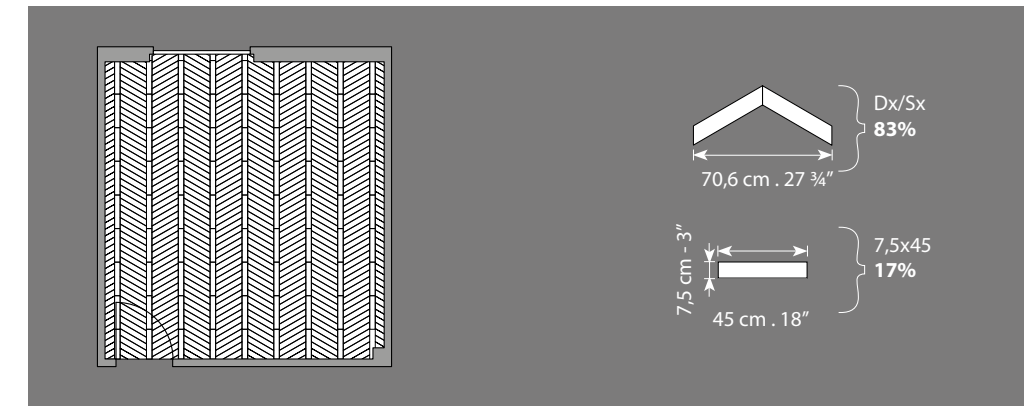

1

Misurare con precisione la larghezza dell'ambiente e tracciare una linea in corrispondenza della mezzeria, posare la prima fila di 7,5x45 come illustrato.

Carefully measure the width of the room and draw the centre line, as shown, then lay the first column.

Mesurer la largeur de la pièce avec précision et tracer une ligne au centre, poser la première rangée de 7,5x45, d'après l'illustration.

Messen Sie genau die Breite des Raumes und markieren Sie die Mittellinie. Verlegen Sie, wie gezeigt, die erste Reihe von 7,5x45.

Medir con precisión la anchura del ambiente y trazar una línea en la mitad; colocar la primera fila de 7,5 x 45 tal como se ilustra.

Точно измерьте ширину помещения и начертите линию по середине, уложите первый ряд 7,5x45, как показано.

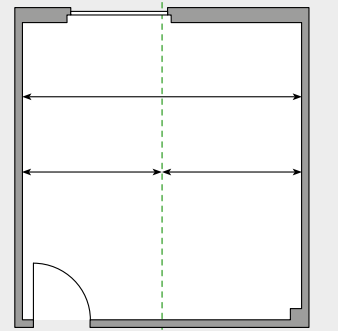

2

Utilizzare una staggia adeguatamente posizionata come guida e posare la prima fila di Chevron come illustrato, lasciando uno spazio libero per la via d'uscita.

Use a levelling bar positioned as a guide, lay the first column of chevrons, as shown, leaving room to leave through.

Utiliser une règle correctement positionnée servant de guide et poser la première rangée de Chevrons d'après l'illustration, en laissant un espace libre pour pouvoir sortir.

Verwenden Sie ein angemessen positioniertes Zieheisen als Führung und verlegen Sie, wie gezeigt, die erste Reihe Chevron, wobei Sie einen Freiraum als Ausgang lassen.

Utilizar una regla adecuadamente posicionada como guía y colocar la primera fila de Chevron de la manera ilustrada, dejando un espacio libre para la vía de salida.

Используйте правильно уложенную рейку в качестве направляющей и уложите первый ряд елочку, как показано, оставляя свободное пространство для выхода.

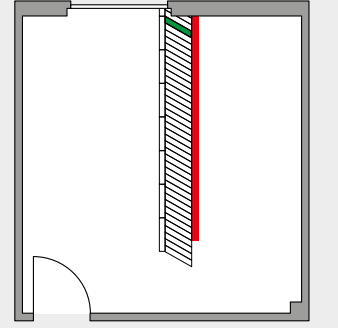

**Inizio posa Chevron** . Start chevron laying . Début de pose Chevron . Beginn der Chevron-Verlegung . Inicio de colocación Chevron . Начало укладки елочку .  
**Staggia** . Levelling bar . Barre . Zieheisen . Regla . Рейка .

3

Completare la posa della prima metà della stanza, posando una sezione alla volta, sempre con l'aiuto di una staggia adeguatamente posizionata.

Finish laying the first half of the room, laying one section at a time, using a suitably positioned levelling bar.

Terminer l'installation de la première moitié de la pièce, en posant une section à la fois, toujours à l'aide d'une règle correctement positionnée.

Kompletieren Sie die Verlegung in der ersten Hälfte des Zimmers, indem Sie jeweils einen Abschnitt mithilfe eines entsprechend positionierten Zieheisens verlegen.

Completar la colocación de la primera mitad de la habitación, colocando una sección por vez, siempre con la ayuda de una regla adecuadamente posicionada.

Завершите укладку первой половины помещения, укладывая один участок за раз, всегда используя правильно уложенную рейку.

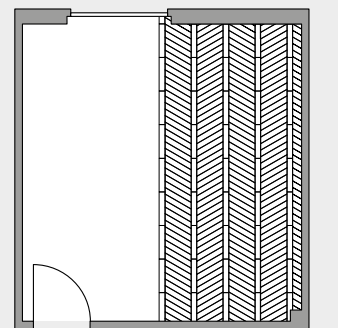

4

Con le stesse modalità, terminare la posa dell'ambiente.

Proceeding in this fashion, finish laying the room.

Terminer la pose du carrelage dans la pièce en suivant les mêmes modalités.

Stellen Sie mit der gleichen Vorgehensweise die Verlegung im Raum fertig.

Proceder de la misma manera para terminar la colocación en la habitación.

Этим же методом завершите укладку во всем помещении.

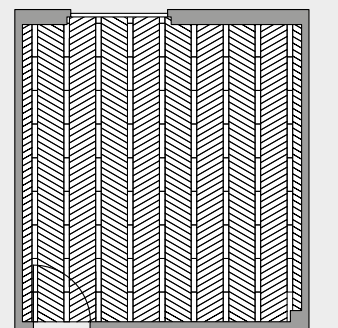

## POSA CHEVRON CON TAPPETO

CHEVRON DESIGN WITH RUG EFFECT  
POSE EN CHEVRON AVEC TAPIS  
CHEVRON-VERLEGUNG MIT TEPPICH  
COLOCACIÓN DE CHEVRON CON ALFOMBRA  
УКЛАДКА В ЕЛОЧКУ С ЭФФЕКТОМ КОВРА

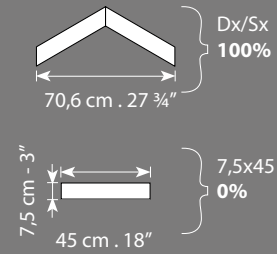
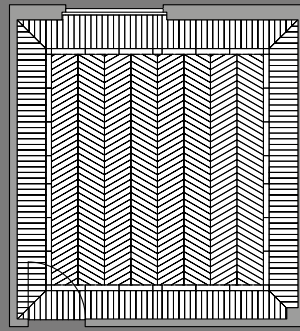

1

Misurare con precisione la larghezza dell'ambiente come illustrato

Carefully measure the width of the room, as shown.

Mesurer la largeur de la pièce avec précision d'après l'illustration.

Messen Sie, wie gezeigt, genau die Breite des Raumes.

Medir con precisión la anchura del ambiente de la manera que se ilustra.

Точно измерьте ширину помещения, как показано.

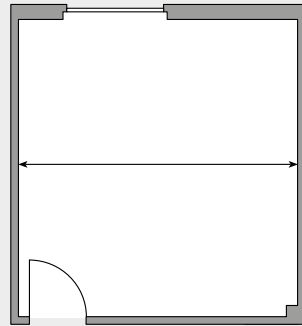

2

Tracciare l'area che dovrà contenere il tappeto centrale, assicurandosi di mantenere per ogni lato la medesima distanza dalle pareti, nel seguente modo:

- Sottrarre sempre la misura costante di 105 cm dalla misura della larghezza dell'ambiente (da esempio 375-105=270).
- Dividere la misura così ottenuta per la lunghezza dello Chevron che è 70,6 cm (270/70,6=3,8).
- Arrotondare il risultato all'intero superiore, quindi 3,8 diventa 4.
- Moltiplicare la lunghezza dello Chevron per il numero appena ricavato (70,6\*4=282,4).
- Per determinare la distanza A (come da esempio) del tappeto centrale rispetto alle pareti, occorre sottrarre il risultato ottenuto dalla larghezza dell'ambiente e dividerlo per 2. Quindi la distanza A sarà: (375-282,4)/2=46,3 cm.

Mark out the central rug effect area, making sure to keep the same distance from the walls for each side, as follows:

- Always subtract 105 cm from the width of the room (for example room measuring 375 cm: 375-105 = 270).
- Then divide the result obtained by the length of the chevron (which is 70.6 cm), e.g. 270 ÷ 70.6 = 3.8.
- Round the result up to the nearest whole number, which means 3.8 becomes 4.
- Multiply the length of the chevron by the number just obtained (70.6 x 4 = 282.4).
- To calculate the distance A (as shown in the example) between the central rug section and the walls, subtract the result obtained from the width of the room and then divide it by 2. Distance A will therefore be: (375-282.4)/2=46.3 cm.

- Tracer la zone qui contiendra le tapis central, en veillant à garder la même distance des murs, comme suit :
- toujours soustraire la mesure constante de 105 cm de la mesure de la largeur de la pièce (par exemple 375-105=270).
- Diviser la mesure ainsi obtenue par la longueur du Chevron qui est de 70,6 cm (270/70,6=3,8).
- Arrondir le résultat à l'entier supérieur : 3,8 devient ainsi 4.
- Multiplier la longueur du Chevron par le nombre qu'on vient d'obtenir (70,6\*4=282,4).
- Pour déterminer la distance A (comme dans l'exemple) du tapis central par rapport aux murs, il faut soustraire le résultat obtenu de la largeur de la pièce et le diviser par 2. La distance A sera donc : (375-282,4)/2=46,3 cm.

Markieren Sie den Bereich, in dem sich der mittlere Teppich befinden soll, und vergewissern Sie sich auf folgende Weise, dass auf jeder Seite den gleichen Abstand zu den Wänden eingehalten wird:

- Ziehen Sie stets das konstante Maß von 105 cm von der gemessenen Raumbreite ab (zum Beispiel 375-105=270).
- Teilen Sie das so erhaltene Maß durch die Länge des Chevron, die 70,6 cm beträgt (270/70,6=3,8).
- Runden Sie das Ergebnis nach oben auf eine ganze Zahl, d.h. 3,8 wird 4.
- Multiplizieren Sie die Länge des Chevron mit der gerade ermittelten Zahl (70,6\*4=282,4).
- Zur Bestimmung des Abstandes A (gemäß Beispiel) des mittleren Teppichs von den Wänden muss das erzielte Ergebnis von der Raumbreite abgezogen und durch 2 geteilt werden. Somit beträgt der Abstand A: (375-282,4)/2=46,3 cm.

Trazar el área que deberá contener la alfombra central, asegurándose de mantener por cada lado la misma distancia respecto de las paredes, procediendo para ello de la siguiente forma:

- Sustraer siempre la medida constante de 105 cm a la medida de anchura del ambiente (por ejemplo: 375-105 = 270).
- Dividir la medida obtenida de esa forma por la longitud del Chevron, que es de 70,6 cm (270/70,6 = 3,8).
- Redondear el resultado al entero superior, por lo que 3,8 pasa a ser 4.
- Multiplicar la longitud del Chevron por el número recién obtenido (70,6\*4 = 282,4).
- Para determinar la distancia A (como en el ejemplo) de la alfombra central respecto de las paredes es necesario sustraer el resultado obtenido a la anchura del ambiente y dividirlo por 2. Así, la distancia A será: (375-282,4)/2 = 46,3 cm.

Начертите линию, в пределах которой должен находиться центральный ковер, убедившись в одинаковости расстояния до стен, действуя следующим образом:

- Всегда вычитайте фиксированный размер 105 см из ширины помещения (например, 375-105=270).
- Разделите полученное значение на длину елочки, которая равна 70,6 см (270/70,6=3,8).
- Округлите значение в большую сторону, следовательно 3,8 станет 4.
- Умножьте длину елочки на только что полученное значение (70,6\*4=282,4).
- Для определения расстояния A (как на примере) от стен до центрального ковра следует вычесть полученный результат из ширины помещения и разделить его на 2. Таким образом, расстояние A будет равно: (375-282,4)/2=46,3 см.

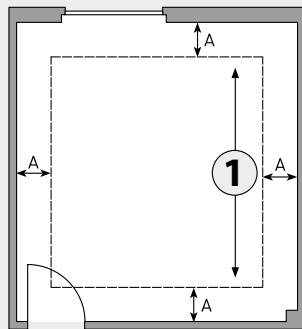

1

**Senso di posa.**  
Laying direction.  
Sens de pose.  
Verlegerichtung.  
Dirección de colocación.  
Направление укладки.

3

Iniziare la posa di fascia e bindello fino a completare due lati dell'ambiente come illustrato, avendo l'accortezza di posare l'eventuale pezzo tagliato contro la parete, in modo da poter poi coprire il taglio con il battiscopa.

Begin laying the outer border band and the inner border line, to complete two sides of the room as illustrated, taking care to lay the cut piece against the wall so that the cut can then be covered with the skirting board.

Commencer la pose des lames de bordure et de raccord et compléter les deux côtés d'après l'illustration, en prenant soin de poser chaque pièce coupée contre le mur, de manière à pouvoir couvrir le côté coupé avec la plinthe.

Beginnen Sie, wie gezeigt, mit der Verlegung des äußeren Streifens und des inneren Randes bis zur Fertigstellung von zwei Seiten des Raumes. Achten Sie dabei darauf, dass eventuell geschnittene Stück zur Wand zu richten, so dass der Schnitt später mit der Sockelleiste verdeckt werden kann.

Iniciar la colocación de línea de borde exterior y línea de borde interior hasta completar dos lados de la habitación de la manera ilustrada, cuidando colocar la eventual pieza cortada contra la pared, a fin de poder cubrir el corte con el rodapié.

Начните укладку бордюра и внутренней полосы вплоть до завершения двух сторон помещения, как показано, обращая внимание на то, чтобы укладывать отрезанную сторону к стене, чтобы затем накрыть срез плинтусом.

**Bindello** . Inner border line . Lame de raccord . Innerer Rand . Línea de borde interior . Полоса .  
**Fascia** . Outer border band . Lame de bordure . Äußerer Streifen . Línea de borde exterior . Бордюр .

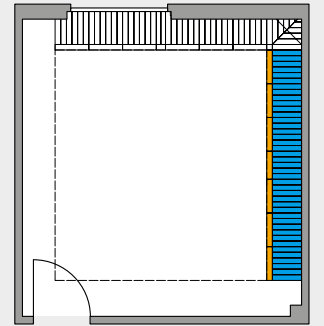

4

Posare il primo Chevron del tappeto centrale come evidenziato in figura. Utilizzare il bindello posato in precedenza e una staggia adeguatamente posizionata come guida. Proseguire la posa fino a terminare l'intera sezione.

Lay the first chevron of the central 'rug' section as shown in the figure. Use the inner border line laid earlier and a suitably positioned levelling bar as a guide. Keep laying until the entire section is finished.

Poser le premier Chevron du tapis central d'après la figure. Utiliser la lame de raccord posée précédemment et une règle correctement positionnée servant de guide. Continuer la pose pour terminer l'ensemble de la section.

Verlegen Sie das erste Chevron des mittleren Teppichs, wie in der Abbildung gezeigt. Verwenden Sie der zuvor verlegte innere Rand und ein angemessen positioniertes Zieheisen als Führung. Setzen Sie die Verlegung bis zur Fertigstellung des gesamten Bereichs fort.

Colocar el primer Chevron de la alfombra central procediendo de la manera ilustrada en la figura. Utilizar la línea de borde interior colocada anteriormente y una regla adecuadamente posicionada como guía. Proseguir la colocación hasta terminar la sección completa.

Уложите первую елочку центрального ковра, как показано на рисунке. Используйте ранее уложенную полосу и правильно уложенную рейку в качестве направляющей. Продолжите укладку вплоть до завершения всего участка.

**Inizio posa Chevron** . Start chevron laying . Début de pose Chevron . Beginn der Chevron-Verlegung . Inicio de colocación Chevron . Начало укладки елочки .  
**Staggia** . Levelling bar . Barre . Zieheisen . Regla . Рейка .

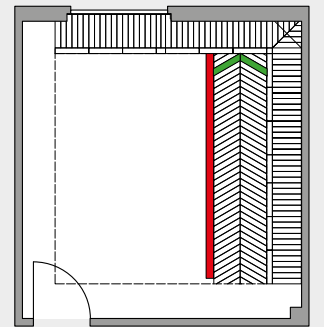

5

Terminare in questo modo l'intera posa del tappeto centrale.

Proceeding in this fashion, finish laying the entire central 'rug' section.

Terminer la pose du tapis central suivant cette modalité.

Beenden Sie auf diese Weise die gesamte Verlegung des mittleren Teppichs.

Terminar de esta forma la colocación completa de la alfombra central.

Завершите таким образом всю укладку центрального ковра.

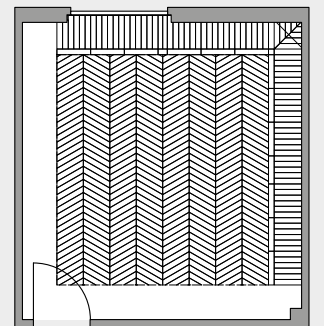

6

Concludere la stanza con la posa di fascia e bindello mancanti.

Finish the room by laying the missing part of the outer border band and the inner border line.

Conclure la pièce en posant les lames de bordure et de raccord manquantes.

Stellen Sie den Raum durch Verlegung der äußeren Streifen und inneren Ränder fertig, die verbleiben.

Concluir la habitación con la colocación de las restantes líneas de borde exterior y líneas de borde interior.

Завершите работу укладкой недостающего бордюра и полосы.

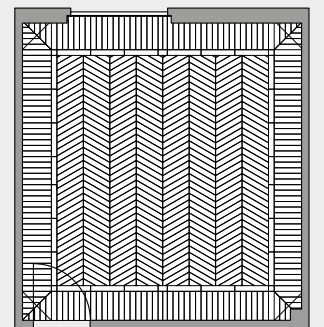



# Caratteristiche tecniche

Technical features . Caracteristiques techniques.  
Technische eigenschaften . Características técnicas . Технические характеристики .

## GRES PORCELLANATO

PORCELAIN TILES . GRES CERAME . FEINSTEINZEUG . GRES PORCELÁNICO . КЕРАМОГРАНИТ .

ISO 13006 - G - Bla (E ≤ 0,5%) UNI EN 14411 - G -

	CARATTERISTICA SPECIFICATION CARACTERISTIQUE EIGENSCHAFT CARACTERÍSTICA СПЕЦИФИКА	METODO DI PROVA TEST METHODS METHODE D'ESSAI TESTVERFAHREN PRUEBA СТАНДАРТ ИСПЫТАНИЙ	VALORE PRESCRITTO GRES PORCELLANATO FIXED VALUE VALEUR PRESCRITE VORGESCHRIEBENER WERT VALOR PRESCRITO ТРЕБУЮМОЕ ЗНАЧЕНИЕ	 Civilization of Beauty		
	<b>CARATTERISTICHE DIMENSIONALI</b> DIMENSIONAL CHARACTERISTICS DIMENSIONS DIMENSIONALE EIGENSCHAFTEN CARACTERÍSTICAS DIMENSIONALES ПРОСТРАНСТВЕННЫЕ ХАРАКТЕРИСТИКИ	ISO 10545-2		NATURALE NATURALE NATURALE NATURALE NATURALE	RETTIFICATO RETTIFICATO RETTIFICATO RETTIFICATO RETTIFICATO	LAPPATO / RETTIFICATO LAPPATO / RETTIFICATO LAPPATO / RETTIFICATO LAPPATO / RETTIFICATO LAPPATO / RETTIFICATO
	LUNGHEZZA E LARGHEZZA . LENGTH AND WIDTH LONGUER ET LARGEUR . LÄNGE UND BREITE LARGURA Y LARQUEZA . ДЛИНА И ШИРИНА		± 0,6 %			
	SPESORE . THICKNESS . EPPASSEUR . STÄRKE . ESPESOR . ТОЛЩИНА		± 5 %			
	RETTILINEITÀ DEGLI SPIGOLI . STRAIGHTNESS OF EDGES RECTITUDE DES BORDS . RECHTECKIGKEIT DER ECKEN ORTOGONALIDAD DE LAS ESQUINAS . ПРЯМОУГЛЕНОСТЬ ГРАНИ		± 0,5 %			
	ORTOGONALITÀ . ORTHOGONALITY . ORTHOGONALITE . RECHTWINKLIGKEIT . ORTOGONALIDAD . ПРЯМОУГОЛЬНОСТЬ		± 0,5 %	CONFORME COMPLIANT CONFORME ERFÜLLT CUMPLE СООТВЕТСТВУЕТ	CONFORME COMPLIANT CONFORME ERFÜLLT CUMPLE СООТВЕТСТВУЕТ	CONFORME COMPLIANT CONFORME ERFÜLLT CUMPLE СООТВЕТСТВУЕТ
	PLANARITÀ (curvatura del centro - curvatura dello spigolo - svergolamento) PLANARITY (Curvature of centre - curvature of edge - bending) PLANARITE (Coubure du centre - courbure de l'arête - gauchissement) EBENHEIT (Krümmung der Mitte - Krümmung der Kante - Verdrehung) PLANEIDAD (Curvatura del centro - curvatura del canto - deformación) ЛИНЕЙНОСТЬ (Изгиб центра - изгиб кромок - перекокс)		± 0,5 %			
	QUALITÀ DELLA SUPERFICIE SURFACE QUALITY QUALITE DE LA SURFACE QUALITÄT DER OBERFLÄCHE CALIDAD DE LA SUPERFICIE ПОВЕРХНОСТЬ	95% DELLE PIASTRELLE ESENTI DA DIFETTI VISIBILI 95% OF TILES SHOW NO VISIBLE DEFECTS 95% DES CARREAUX SONT DÉPOURVUS DE DÉFAUTS VISIBLES 95% DER FLIESEN SIND FREI VON SICHTBAREN FEHLERN 95% DE LAS BALDOSAS EXENTAS DE DEFECTOS VISIBLES TAL 95% ПЛИТКИ НЕ ИМЕЕТ ВИДИМЫХ ДЕФЕКТОВ В				
	ASSORBIMENTO D'ACQUA . WATER ABSORPTION ABSORPTION D'EAU . WASSERAUFNAHME ABSORCIÓN DE AGUA . ВОДОПОГЛАЩЕНИЕ	ISO 10545-3	E <sub>s</sub> ≤ 0,5 %		CONFORME . COMPLIANT CONFORME . ERFÜLLT CUMPLE . СООТВЕТСТВУЕТ	
	RESISTENZA ALLA FLESSIONE . BREAKING MODULUS RESISTANCE A LA FLEXION . BIEGEFESTIGKEIT RESISTENCIA A LA FLEXIÓN . ПРОЧНОСТЬ НА ИЗГИБ	ISO 10545-4	min. 35 N/mm <sup>2</sup>	CONFORME . COMPLIANT CONFORME . ERFÜLLT CUMPLE . СООТВЕТСТВУЕТ	CONFORME . COMPLIANT CONFORME . ERFÜLLT CUMPLE . СООТВЕТСТВУЕТ	
	SFORZO DI ROTTURAZIONE . MODULUS OF RUPTURE CHARGE DE RUPTURE . BRUCHLAST ESFUERZO DE ROTURA . СТОЙКОСТЬ НА ИЗГИБ		SPESORE . THICKNESS ≥ 7,5 mm: min. 1300 N EPPASSEUR . STÄRKE ESPESOR . ТОЛЩИНА < 7,5 mm: min. 700 N	CONFORME . COMPLIANT CONFORME . ERFÜLLT CUMPLE . СООТВЕТСТВУЕТ	CONFORME . COMPLIANT CONFORME . ERFÜLLT CUMPLE . СООТВЕТСТВУЕТ	
	RESISTENZA ALLA ABRASIONE DELLA SUPERFICIE DI PIASTRELLE SMALTATE RESISTANCE TO SURFACE ABRASION OF GLAZED TILES RÉSISTANCE À L'ABRASION DE LA SURFACE DES CARREAUX ÉMAILLÉS WIDERSTAND GEGEN ABRABIER DER OBERFLÄCHE DER GLASIERTEN FLIESEN RESISTENCIA A LA ABRASIÓN DE LA SUPERFICIE DE BALDOSAS ESMALTADAS ПОВЕРХНОСТНОМУ ИСТЯРНИЮ ИСТЯРНИЮ	ISO 10545-7	CLASSI 0-5	SECONDO QUANTO DICHIARATO AS DECLARED UIVANT LES DÉCLARATIONS GEMÄSS DEN ANGABEN SEGÜN LO DECLARADO КАК ЗАЯВИЛ		
	COEFFICIENTE DI DILATAZIONE TERMICA LINEARE . THERMAL EXPANSION COEFFICIENT COEFFICIENT DE DILATATION THERMIQUE LINEAIRE . WÄRMEAUSDEHNUNGSKOEFFIZIENT COEFFICIENTE DE DILATACIÓN TÉRMICA LINEAL . ЦККОЭФФИЦИЕНТ ТЕПЛООВОГО ЛИНЕЙНОГО РАСШИРЕНИЯ	ISO 10545-8	METODO DISPONIBILE . AVAILABLE ON REQUEST METHODE DISPONIBLE . VERFÜGBARES VERFAHREN METODO DISPONIBLE . ОПРЕДЕЛЯЕТСЯ ПРОИЗВОДИТЕЛЕМ	≤ 7x10 <sup>-6</sup> °C <sup>-1</sup>	CONFORME . COMPLIANT CONFORME . ERFÜLLT CUMPLE . СООТВЕТСТВУЕТ	
	RESISTENZA AL CAVILLO . CRAZING RESISTANCE RESISTANCE AUX TRESAILLURES . HAARRISSE RESISTENCIA AL QUARTEADO . СТОЙКОСТЬ К ОБРАЗОВАНИЮ ПЯТЕН	ISO 10545-11	RICHIESTA . ALWAYS TESTED EXIGEE . NOT WENIG PEDIDO . ТРЕБОВАНИЯ	RESISTENTI . RESISTANT RESISTANTS . WIDERSTANDSFÄHIG RESISTE . УСТОЙЧИВЫ		
	RESISTENZA AGLI SBALZI TERMICI . THERMAL SHOCK RESISTANCE RESISTANCE AUX ECARTS DE TEMPERATURE . TEMPERATURWECHSELBESTÄNDIGKEIT RESISTENCIA A CHOQUE TÉRMICO . УСТОЙЧИВОСТЬ К ТЕМПЕРАТУРНЫМ ПЕРЕПАДАМ	ISO 10545-9	METODO DISPONIBILE . AVAILABLE ON REQUEST METHODE DISPONIBLE . VERFÜGBARES VERFAHREN METODO DISPONIBLE . ОПРЕДЕЛЯЕТСЯ ПРОИЗВОДИТЕЛЕМ	RESISTENTI . RESISTANT RESISTANTS . WIDERSTANDSFÄHIG RESISTE . УСТОЙЧИВЫ		
	RESISTENZA AL GELO . FROST RESISTANCE RESISTANCE AU GEL . FROSTBESTÄNDIGKEIT RESISTENCIA AL HIELO . МОРОЗОСТОЙКОСТЬ	ISO 10545-12	RICHIESTA . ALWAYS TESTED EXIGEE . NOT WENIG PEDIDO . ТРЕБОВАНИЯ	RESISTENTI . RESISTANT RESISTANTS . WIDERSTANDSFÄHIG RESISTE . УСТОЙЧИВЫ		
	PRODOTTI CHIMICI AD USO DOMESTICO ED ADDITIVI PER PISCINA HOUSEHOLD CHEMICALS AND SWIMMING POOL WATER CLEANSERS PRODUITS CHIMIQUES COURANTS ET ADDITIFS POUR PISCINE CHEM. PRODUKTE FÜR DEN HAUSHALTSGEBRAUCH UND ZUSATZ FÜR SCHWIMMBÄDER PRODUCTOS QUÍMICOS PARA USO DOMÉSTICO Y CON ADITIVOS PARA PISCINA Бытовые химические средства и средства для бассейнов	ISO 10545-13	METODO DISPONIBILE . AVAILABLE ON REQUEST METHODE DISPONIBLE . VERFÜGBARES VERFAHREN METODO DISPONIBLE . ОПРЕДЕЛЯЕТСЯ ПРОИЗВОДИТЕЛЕМ	CONFORME COMPLIANT CONFORME ERFÜLLT CUMPLE СООТВЕТСТВУЕТ		
	ACIDI ED ALCALI A BASSA CONCENTRAZIONE ACIDS AND LOW CONCENTRATION ALKALIS ACIDES ET ALCALI A FAIBLE CONCENTRATION SÄUREN UND ALKALI IN GERINGER KONZENTRATION ÁCIDOS Y ALCALIS EN BAJA CONCENTRACIÓN Низкоконцентрированные кислоты и щелочи		COME DICHIARATO DAL PRODUTTORE AS DECLARED BY THE MANUFACTURER COMME LE DÉCLARE LE PRODUCTEUR WIE VOM HERSTELLER ERKLÄRT COMO DECLARA EL FABRICANTE СООТВЕТСТВИИ С ЗАЯВЛЕНИЯМИ ПРОИЗВОДИТЕЛЯ	RESISTENTI . RESISTANT RESISTANTS . WIDERSTANDSFÄHIG RESISTE . УСТОЙЧИВЫ		
	ACIDI ED ALCALI AD ALTA CONCENTRAZIONE . ACIDS AND HIGH CONCENTRATION ALKALIS ACIDES ET ALCALI A FORTE CONCENTRATION . SÄUREN UND ALKALI IN HOHER KONZENTRATION ÁCIDOS Y ALCALIS EN ALTA CONCENTRACIÓN . ВЫСОКОКОНЦЕНТРИРОВАННЫЕ КИСЛОТЫ И ЩЕЛОЧИ		METODO DISPONIBILE . AVAILABLE ON REQUEST METHODE DISPONIBLE . VERFÜGBARES VERFAHREN METODO DISPONIBLE . ОПРЕДЕЛЯЕТСЯ ПРОИЗВОДИТЕЛЕМ	RESISTENTI . RESISTANT RESISTANTS . WIDERSTANDSFÄHIG RESISTE . УСТОЙЧИВЫ		
	RESISTENZA ALLE MACCHIE . STAIN RESISTANCE RESISTANCE AUX TACHES . FLECKBESTÄNDIGKEIT RESISTENCIA A LAS MANCHAS . УСТОЙЧИВОСТЬ К ЗАГРЯЗНЕНИЮ	ISO 10545-14	CLASSE 3 min.	RESISTENTI . RESISTANT RESISTANTS . WIDERSTANDSFÄHIG RESISTE . УСТОЙЧИВЫ		
	STABILITÀ DEI COLORI ALLA LUCE COLOUR STABILITY TO LIGHT STABILITÉ DES COULEURS A LA LUMIERE LICHTECHTHEIT DER FARBEN ESTABILIDAD DE LOS COLORES УСТОЙЧИВОСТЬ ЦВЕТА	DIN 51094	NON DEVONO PRESENTARE APPREZZABILI VARIAZIONI DI COLORE THEY DO NOT HAVE TO SHOW VISIBLE COLOUR ALTERATION PAS DE MODIFICATIONS SENSIBLES DE COULEUR WEISEN KEINE SICHTBAREN FARBABWEICHUNGEN AUF NO DEBEN PRESENTAR VARIACIONES DE COLOR APRECIABLES НЕ ДОЛЖНЫ ИМЕТЬ ЗАМЕТНЫХ РАЗЛИЧИЙ В ЦВЕТЕ	CONFORME COMPLIANT CONFORME ERFÜLLT CUMPLE СООТВЕТСТВУЕТ		
	COEFFICIENTE DI ATTRITO (Scivolosità) FRICTION COEFFICIENT (Slip risk) COEFFICIENT DE FROTTEMENT (glissance) REIBUNGSKOEFFIZIENT (Glätte) COEFFICIENTE DE FRICCIÓN (Deslizabilidad) КОЭФФИЦИЕНТ ТРЕНИЯ (Скользкость)	DIN 51130 DIN 51097 D.M. 236/89 B.C.R. ANSI A 137.1:2012	DOVE RICHIESTA IF NEEDED SI DEMANDE NACH ANFORDERUNG SI REQUERIDO ДЕ СЛЕДУЕТ	A RICHIESTA AVAILABLE ON REQUEST SI DEMANDE AUF ANFRAGE BAJO PEDIDO ПО ЗАПРОСУ		

## GRES PORCELLANATO COLORATO IN MASSA

COLORED BODY PORCELAIN STONWARE

GRÉS CÉRAMÉ COLORÉ DANS LA MASSE . EINGEFÄRBTES FEINSTEINZEUG

GRES PORCELÁNICO COLOREADO EN MASA . КЕРАМОГРАНИТ ОКРАШЕННЫЙ В МАССЕ

ISO 13006 - G - Bla (E ≤ 0,5%) UNI EN 14411 - G -

	CARATTERISTICA SPECIFICATION CARACTERISTIQUE EIGENSCHAFT CARACTERÍSTICA СПЕЦИФИКА	METODO DI PROVA TEST METHODS METHODE D'ESSAI TESTVERFAHREN PRUEBA СТАНДАРТ ИСПЫТАНИЙ	VALORE PRESCRITTO GRES PORCELLANATO COLORATO IN MASSA FIXED VALUE VALEUR PRESCRITE VORGESCHRIEBENER WERT VALOR PRESCRITO ТРЕБУЮМОЕ ЗНАЧЕНИЕ	 Civilization of Beauty		
	<b>CARATTERISTICHE DIMENSIONALI</b> DIMENSIONAL CHARACTERISTICS DIMENSIONS DIMENSIONALE EIGENSCHAFTEN CARACTERÍSTICAS DIMENSIONALES ПРОСТРАНСТВЕННЫЕ ХАРАКТЕРИСТИКИ	ISO 10545-2		NATURALE NATURALE NATURALE NATURALE NATURALE	RETTIFICATO RETTIFICATO RETTIFICATO RETTIFICATO RETTIFICATO	LAPPATO / RETTIFICATO LAPPATO / RETTIFICATO LAPPATO / RETTIFICATO LAPPATO / RETTIFICATO LAPPATO / RETTIFICATO
	LUNGHEZZA E LARGHEZZA . LENGTH AND WIDTH LONGUER ET LARGEUR . LÄNGE UND BREITE LARGURA Y LARQUEZA . ДЛИНА И ШИРИНА		± 0,6 %			
	SPESORE . THICKNESS . EPPASSEUR . STÄRKE . ESPESOR . ТОЛЩИНА		± 5 %			
	RETTILINEITÀ DEGLI SPIGOLI . STRAIGHTNESS OF EDGES RECTITUDE DES BORDS . RECHTECKIGKEIT DER ECKEN ORTOGONALIDAD DE LAS ESQUINAS . ПРЯМОУГЛЕНОСТЬ ГРАНИ		± 0,5 %			
	ORTOGONALITÀ . ORTHOGONALITY . ORTHOGONALITE . RECHTWINKLIGKEIT . ORTOGONALIDAD . ПРЯМОУГОЛЬНОСТЬ		± 0,5 %	CONFORME COMPLIANT CONFORME ERFÜLLT CUMPLE СООТВЕТСТВУЕТ	CONFORME COMPLIANT CONFORME ERFÜLLT CUMPLE СООТВЕТСТВУЕТ	CONFORME COMPLIANT CONFORME ERFÜLLT CUMPLE СООТВЕТСТВУЕТ
	PLANARITÀ (curvatura del centro - curvatura dello spigolo - svergolamento) PLANARITY (Curvature of centre - curvature of edge - bending) PLANARITE (Coubure du centre - courbure de l'arête - gauchissement) EBENHEIT (Krümmung der Mitte - Krümmung der Kante - Verdrehung) PLANEIDAD (Curvatura del centro - curvatura del canto - deformación) ЛИНЕЙНОСТЬ (Изгиб центра - изгиб кромок - перекокс)		± 0,5 %			
	QUALITÀ DELLA SUPERFICIE SURFACE QUALITY QUALITE DE LA SURFACE QUALITÄT DER OBERFLÄCHE CALIDAD DE LA SUPERFICIE ПОВЕРХНОСТЬ	95% DELLE PIASTRELLE ESENTI DA DIFETTI VISIBILI 95% OF TILES SHOW NO VISIBLE DEFECTS 95% DES CARREAUX SONT DÉPOURVUS DE DÉFAUTS VISIBLES 95% DER FLIESEN SIND FREI VON SICHTBAREN FEHLERN 95% DE LAS BALDOSAS EXENTAS DE DEFECTOS VISIBLES TAL 95% ПЛИТКИ НЕ ИМЕЕТ ВИДИМЫХ ДЕФЕКТОВ В				
	ASSORBIMENTO D'ACQUA . WATER ABSORPTION ABSORPTION D'EAU . WASSERAUFNAHME ABSORCIÓN DE AGUA . ВОДОПОГЛАЩЕНИЕ	ISO 10545-3	E <sub>s</sub> ≤ 0,5 %		CONFORME . COMPLIANT CONFORME . ERFÜLLT CUMPLE . СООТВЕТСТВУЕТ	
	RESISTENZA ALLA FLESSIONE . BREAKING MODULUS RESISTANCE A LA FLEXION . BIEGEFESTIGKEIT RESISTENCIA A LA FLEXIÓN . ПРОЧНОСТЬ НА ИЗГИБ	ISO 10545-4	35 N/mm <sup>2</sup>	CONFORME . COMPLIANT CONFORME . ERFÜLLT CUMPLE . СООТВЕТСТВУЕТ	CONFORME . COMPLIANT CONFORME . ERFÜLLT CUMPLE . СООТВЕТСТВУЕТ	
	SFORZO DI ROTTURAZIONE . MODULUS OF RUPTURE CHARGE DE RUPTURE . BRUCHLAST ESFUERZO DE ROTURA . СТОЙКОСТЬ НА ИЗГИБ		SPESORE . THICKNESS ≥ 7,5 mm: min. 1300 N EPPASSEUR . STÄRKE ESPESOR . ТОЛЩИНА < 7,5 mm: min. 700 N	CONFORME . COMPLIANT CONFORME . ERFÜLLT CUMPLE . СООТВЕТСТВУЕТ	CONFORME . COMPLIANT CONFORME . ERFÜLLT CUMPLE . СООТВЕТСТВУЕТ	
	DETERMINAZIONE DELLA RESISTENZA A FLESSIONE E CARICO DI ROTTURAZIONE DETERMINATION OF BREAKING MODULUS AND MODULUS OF RUPTURE DETERMINATION DE LA RESISTANCE A LA FLEXION ET À LA CHARGE DE RUPTURE BESTIMMUNG DER BIEGEFESTIGKEIT UND DER BRUCHLASTBESTÄNDIGKEIT DETERMINACIÓN DE LA RESISTENCIA A FLEXIÓN Y CARGA DE ROTURA ОПРЕДЕЛЕНИЕ ПРОЧНОСТИ НА ИЗГИБ И РАЗРУШАЮЩЕЙ НАГРУЗКИ	UNI EN 1339:2005 / COR. 2011 ANNEX F		SPESORE . THICKNESS EPPASSEUR . STÄRKE ESPESOR . ТОЛЩИНА 20 mm	CLASSE U11	
	RESISTENZA ALL'ABRAZIONE PROFONDA . DEEP ABRASION RESISTANCE RESISTANCE A L'ABRASION PROFONDE . BESTÄNDIGKEIT GEGEN TIEFENVERSCHLEISS RESISTENCIA A LA ABRASION PROFUNDA . УСТОЙЧИВОСТЬ К ГЛУБОКОМУ СТЯРНИЮ ПО	ISO 10545-6	≤ 175 mm <sup>3</sup>	CONFORME . COMPLIANT CONFORME . ERFÜLLT CUMPLE . СООТВЕТСТВУЕТ		
	COEFFICIENTE DI DILATAZIONE TERMICA LINEARE . THERMAL EXPANSION COEFFICIENT COEFFICIENT DE DILATATION THERMIQUE LINEAIRE . WÄRMEAUSDEHNUNGSKOEFFIZIENT COEFFICIENTE DE DILATACIÓN TÉRMICA LINEAL . ЦККОЭФФИЦИЕНТ ТЕПЛООВОГО ЛИНЕЙНОГО РАСШИРЕНИЯ	ISO 10545-8	METODO DISPONIBILE . AVAILABLE ON REQUEST METHODE DISPONIBLE . VERFÜGBARES VERFAHREN METODO DISPONIBLE . ОПРЕДЕЛЯЕТСЯ ПРОИЗВОДИТЕЛЕМ	≤ 7x10 <sup>-6</sup> °C <sup>-1</sup>	CONFORME . COMPLIANT CONFORME . ERFÜLLT CUMPLE . СООТВЕТСТВУЕТ	
	RESISTENZA AGLI SBALZI TERMICI . THERMAL SHOCK RESISTANCE RESISTANCE AUX ECARTS DE TEMPERATURE . TEMPERATURWECHSELBESTÄNDIGKEIT RESISTENCIA A CHOQUE TÉRMICO . УСТОЙЧИВОСТЬ К ТЕМПЕРАТУРНЫМ ПЕРЕПАДАМ	ISO 10545-9	METODO DISPONIBILE . AVAILABLE ON REQUEST METHODE DISPONIBLE . VERFÜGBARES VERFAHREN METODO DISPONIBLE . ОПРЕДЕЛЯЕТСЯ ПРОИЗВОДИТЕЛЕМ	RESISTENTI . RESISTANT RESISTANTS . WIDERSTANDSFÄHIG RESISTE . УСТОЙЧИВЫ		
	RESISTENZA AL GELO . FROST RESISTANCE RESISTANCE AU GEL . FROSTBESTÄNDIGKEIT RESISTENCIA AL HIELO . МОРОЗОСТОЙКОСТЬ	ISO 10545-12	RICHIESTA . ALWAYS TESTED EXIGEE . NOT WENIG PEDIDO . ТРЕБОВАНИЯ	RESISTENTI . RESISTANT RESISTANTS . WIDERSTANDSFÄHIG RESISTE . УСТОЙЧИВЫ		
	PRODOTTI CHIMICI AD USO DOMESTICO ED ADDITIVI PER PISCINA HOUSEHOLD CHEMICALS AND SWIMMING POOL WATER CLEANSERS PRODUITS CHIMIQUES COURANTS ET ADDITIFS POUR PISCINE CHEM. PRODUKTE FÜR DEN HAUSHALTSGEBRAUCH UND ZUSATZ FÜR SCHWIMMBÄDER PRODUCTOS QUÍMICOS PARA USO DOMÉSTICO Y CON ADITIVOS PARA PISCINA Бытовые химические средства и средства для бассейнов	ISO 10545-13	METODO DISPONIBILE . AVAILABLE ON REQUEST METHODE DISPONIBLE . VERFÜGBARES VERFAHREN METODO DISPONIBLE . ОПРЕДЕЛЯЕТСЯ ПРОИЗВОДИТЕЛЕМ	CONFORME COMPLIANT CONFORME ERFÜLLT CUMPLE СООТВЕТСТВУЕТ		UA
	ACIDI ED ALCALI A BASSA CONCENTRAZIONE ACIDS AND LOW CONCENTRATION ALKALIS ACIDES ET ALCALI A FAIBLE CONCENTRATION SÄUREN UND ALKALI IN GERINGER KONZENTRATION ÁCIDOS Y ALCALIS EN BAJA CONCENTRACIÓN Низкоконцентрированные кислоты и щелочи		COME DICHIARATO DAL PRODUTTORE AS DECLARED BY THE MANUFACTURER COMME LE DÉCLARE LE PRODUCTEUR WIE VOM HERSTELLER ERKLÄRT COMO DECLARA EL FABRICANTE СООТВЕТСТВИИ С ЗАЯВЛЕНИЯМИ ПРОИЗВОДИТЕЛЯ	RESISTENTI . RESISTANT RESISTANTS . WIDERSTANDSFÄHIG RESISTE . УСТОЙЧИВЫ		
	ACIDI ED ALCALI AD ALTA CONCENTRAZIONE . ACIDS AND HIGH CONCENTRATION ALKALIS ACIDES ET ALCALI A FORTE CONCENTRATION . SÄUREN UND ALKALI IN HOHER KONZENTRATION ÁCIDOS Y ALCALIS EN ALTA CONCENTRACIÓN . ВЫСОКОКОНЦЕНТРИРОВАННЫЕ КИСЛОТЫ И ЩЕЛОЧИ		METODO DISPONIBILE . AVAILABLE ON REQUEST METHODE DISPONIBLE . VERFÜGBARES VERFAHREN METODO DISPONIBLE . ОПРЕДЕЛЯЕТСЯ ПРОИЗВОДИТЕЛЕМ	RESISTENTI . RESISTANT RESISTANTS . WIDERSTANDSFÄHIG RESISTE . УСТОЙЧИВЫ		
	RESISTENZA ALLE MACCHIE . STAIN RESISTANCE RESISTANCE AUX TACHES . FLECKBESTÄNDIGKEIT RESISTENCIA A LAS MANCHAS . УСТОЙЧИВОСТЬ К ЗАГРЯЗНЕНИЮ	ISO 10545-14	CLASSE 3 min.	RESISTENTI . RESISTANT RESISTANTS . WIDERSTANDSFÄHIG RESISTE . УСТОЙЧИВЫ		
	STABILITÀ DEI COLORI ALLA LUCE COLOUR STABILITY TO LIGHT STABILITÉ DES COULEURS A LA LUMIERE LICHTECHTHEIT DER FARBEN ESTABILIDAD DE LOS COLORES УСТОЙЧИВОСТЬ ЦВЕТА	DIN 51094	NON DEVONO PRESENTARE APPREZZABILI VARIAZIONI DI COLORE THEY DO NOT HAVE TO SHOW VISIBLE COLOUR ALTERATION PAS DE MODIFICATIONS SENSIBLES DE COULEUR WEISEN KEINE SICHTBAREN FARBABWEICHUNGEN AUF NO DEBEN PRESENTAR VARIACIONES DE COLOR APRECIABLES НЕ ДОЛЖНЫ ИМЕТЬ ЗАМЕТНЫХ РАЗЛИЧИЙ В ЦВЕТЕ	CONFORME COMPLIANT CONFORME ERFÜLLT CUMPLE СООТВЕТСТВУЕТ		
	COEFFICIENTE DI ATTRITO (Scivolosità) FRICTION COEFFICIENT (Slip risk) COEFFICIENT DE FROTTEMENT (glissance) REIBUNGSKOEFFIZIENT (Glätte) COEFFICIENTE DE FRICCIÓN (Deslizabilidad) КОЭФФИЦИЕНТ ТРЕНИЯ (Скользкость)	DIN 51130 DIN 51097 D.M. 236/89 B.C.R. ANSI A 137.1:2012	DOVE RICHIESTA IF NEEDED SI DEMANDE NACH ANFORDERUNG SI REQUERIDO ДЕ СЛЕДУЕТ	A RICHIESTA AVAILABLE ON REQUEST SI DEMANDE AUF ANFRAGE BAJO PEDIDO ПО ЗАПРОСУ		

# Consigli per la corretta pulizia e manutenzione del prodotto

Eseguire una precisa e corretta pulizia del prodotto ceramico è di fondamentale importanza per mantenerne nel tempo l'originaria lucentezza e bellezza. Si raccomanda pertanto di seguire con attenzione le indicazioni seguenti.

## A) PULIZIA "DOPO-POSA" IN CANTIERE

**Il lavaggio iniziale delle piastrelle nel "dopo-posa" in cantiere è una fase di fondamentale importanza.**

È infatti in questo momento che è possibile rimuovere agevolmente dalle piastrelle tutti i residui dei materiali usati per la posa e/o della stuccatura delle fughe della piastrella stessa. Si tratta di residui di varia natura che, se lasciati "asciugare e/o seccare" sulle piastrelle, soprattutto in quelle caratterizzate da una superficie strutturata più o meno accentuata (ad esempio le collezioni FUSION, PIETRA LAVICA, 5TH AVENUE, ecc...) potrebbero diventare difficili da rimuovere successivamente.

Si raccomanda sempre la massima attenzione alla scelta dell'agente pulente per non alterare irrimediabilmente il grado di lucentezza e brillantezza della piastrella posata.

**Pulizia del pavimento stuccato con "Stucchi cementizi a base d'acqua"**

Come già accennato, con il lavaggio "dopo-posa" si rimuovono i residui di cemento, stucchi cementizi, salinitri, colle ed eventuali residui superficiali del materiale di varia natura. In questa fase il pavimento deve essere lavato con detersivi a base di acidi tamponati entro almeno 3-4 giorni dopo la posa e mai oltre i 10 giorni. NB: Per i prodotti caratterizzati da superfici strutturate e/o antiscivolo (ad esempio le collezioni FUSION, PIETRA LAVICA, PIETRE MILIARI, ecc...) si raccomanda, viste le asperità della struttura, di sporcare il meno possibile la superficie della piastrella durante le fasi della posa e di pulire bene subito dopo la stuccatura gli eccessi di materiali utilizzati con una spugna bagnata in acqua pulita. Si raccomanda altresì di eseguire la procedura sotto-descritta il prima possibile e comunque prima dei su citati 3-4 giorni massimi dal "dopo-posa".

**Detersivi consigliati:**

Keranet.....	Mapei
Deterdek.....	Fila
Deltaplus.....	Kerakoll
Cement Remover.....	Faber Chimica
Deterpav Professional.....	Madras
Gres Cleaner Extreme Special.....	Priscopio Soluzioni
Solvacid.....	Geal

**Procedere come segue:**

- Preparare il detergente come indicato in etichetta (si consiglia di effettuare prove preliminari su piastrelle non posate per verificare l'inalterabilità della superficie della piastrella).
- Bagnare preventivamente il pavimento con acqua pulita.
- Stendere la soluzione sulle piastrelle lasciando che agisca per qualche minuto.
- Passare la monospazzola utilizzando dischi appropriati (verdi per le superfici strutturate e rosso per le non strutturate) o una paglietta (verde per le superfici strutturate e rossa/marrone per le non strutturate) strofinando energicamente la superficie delle piastrelle.
- Risciacquare abbondantemente con acqua pulita aspirando il liquido.

**Pulizia del pavimento stuccato con "Stucchi epossidici"**

Nel caso di utilizzo di stucchi epossidici, considerato che essi induriscono rapidamente in pochi minuti, il lavaggio "dopo-posa" deve essere eseguito con detersivi alcalini il più rapidamente possibile attenendosi scrupolosamente alle indicazioni e procedure d'utilizzo indicati in etichetta.

**Detersivi alcalini consigliati:**

Kerapoxy Cleaner.....	Mapei
PS/87.....	Fila
Epoxy Remover.....	Laticrete
Keragel Eco.....	Kerakoll
Wax Remover.....	Faber Chimica
Epoxy.Det.....	Technokolla
Epoxy Cleaner Extreme.....	Periscopio Soluzioni
Eposolu.....	Geal

**Procedere come segue:**

- Preparare il detergente come indicato in etichetta (si consiglia di effettuare prove preliminari su piastrelle non posate per verificare l'inalterabilità della superficie della piastrella).
- Bagnare preventivamente il pavimento con acqua pulita.
- Stendere la soluzione sulle piastrelle lasciando che agisca per qualche minuto
- Passare la monospazzola utilizzando dischi appropriati (verdi per le superfici strutturate e rosso per le non strutturate) o una paglietta (verde per le superfici strutturate e rossa/marrone per le non strutturate) strofinando energicamente la superficie delle piastrelle.
- Risciacquare abbondantemente con acqua pulita aspirando il liquido

## B) PULIZIA QUOTIDIANA

La pulizia ordinaria può essere fatta con l'ausilio di normali detersivi neutri adatti alla pulizia delle superfici ceramiche, eventualmente diluendoli in acqua calda per aumentarne l'efficacia, attenendosi alle istruzioni in etichetta del produttore.

## Important product cleaning and maintenance

Proper, careful cleaning of your ceramic product is vitally important to ensure it keeps its original gloss and beauty over time. We therefore recommend that you follow the instructions set out below carefully.

## A) POST-LAYING CLEANING IN THE WORKSITE

**The initial post-laying cleaning of the tiles in the worksite is a key procedure.**

In actual fact, this is the easiest time to remove any residues of the laying materials used and/or grouting from the tiles.

These residues (of various kinds) may be hard to remove later if left to dry on the tiles, particularly those featuring a textured surface (for example the FUSION, PIETRA LAVICA, 5TH AVENUE collections etc...) however accentuated this texture may or may not be. We always recommend you take particular care when choosing the cleaning agent, as the wrong product could irreversibly alter the level of glossy and shine of the laid tiles.

**Cleaning flooring grouted with water-based cement grouts**

As already mentioned, the post-laying wash removes all traces of cement, cement-based grouts, saltpetre, glues and any surface residues of various kinds of materials. At this stage, the floor should be washed with detergents containing buffered acids at least 3-4 days after laying and never later than 10 days afterwards. NB: For tiling with textured and/or non-slip surfaces (for example FUSION, PIETRA LAVICA, PIETRE MILIARI collections etc...) we recommend that – given the harshness of the texture - you try to soil the tile surface as little as possible during laying and that you clean off excess materials well straight after grouting, using a wet sponge and clean water. We also recommend you carry out the procedure described below as soon as possible and within no more than the aforesaid 3 to 4 days after laying.

**Recommended detergents:**

Keranet.....	Mapei
Deterdek.....	Fila
Deltaplus.....	Kerakoll
Cement Remover.....	Faber Chimica
Deterpav Professional.....	Madras
Gres Cleaner Extreme Special.....	Priscopio Soluzioni
Solvacid.....	Geal

**Proceed as follows:**

- Prepare the detergent as stated on the label (we recommend you carry out a preliminary test on unlaid tiles to check the resistance of the tile surface).
- Wet the floor with clean water beforehand.
- Spread the solution on the tiles, leaving it to work for a few minutes.
- Go over the floor with the single-disc floor cleaner, using suitable disks ( i.e. green for textured surfaces and red for non-textured surfaces) or an abrasive pad (green for textured surfaces and red/ brown for non-textured surfaces) , scrubbing surface of the tiles well.
- Rinse thoroughly with clean water, then vacuum up the liquid.

**Cleaning flooring grouted with epoxy grouts**

If you are using an epoxy grout, given that these harden extremely quickly (in just a few minutes), the post-laying wash must be carried out using alkaline cleaning agents and as quickly as possible, following the instructions for use and procedures on the label exactly as stated.

**Recommended alkaline detergents:**

Kerapoxy Cleaner.....	Mapei
PS/87.....	Fila
Epoxy Remover.....	Laticrete
Keragel Eco.....	Kerakoll
Wax Remover.....	Faber Chimica
Epoxy.Det.....	Technokolla
Epoxy Cleaner Extreme.....	Periscopio Soluzioni
Eposolu.....	Geal

**Proceed as follows:**

- Prepare the detergent as stated on the label (we recommend you carry out a preliminary test on unlaid tiles to check the resistance of the tile surface).
- Wet the floor with clean water beforehand.
- Spread the solution on the tiles, leaving it to work for a few minutes.
- Go over the floor with the single-disc floor cleaner, using suitable disks ( i.e. green for textured surfaces and red for non-textured surfaces) or an abrasive pad (green for textured surfaces and red/ brown for non-textured surfaces) , scrubbing surface of the tiles well.
- Rinse thoroughly with clean water, then vacuum up the liquid.

## B) DAILY CLEANING

Routine cleaning can be carried out using normal neutral detergents that are suitable for cleaning ceramic surfaces, diluting them in hot water (if possible) to increase their effectiveness and following the manufacturer's instructions found on the label.

## Conseils pour le nettoyage et l'entretien corrects du produit

Un nettoyage minutieux et correct du produit en céramique est fondamentalement en préserver le brillant et la beauté d'origine. Il est donc recommandé de suivre avec attention les indications suivantes.

## A) NETTOYAGE "APRÈS LA POSE" SUR LE CHANTIER

**Le lavage initial des carreaux au cours de la phase "après la pose" sur le chantier est une étape extrêmement importante.**

En effet, c'est à ce moment-là qu'il est possible d'éliminer facilement des carreaux tous les résidus du matériel utilisé pour la pose et/ou du jointage des joints.

Il s'agit de résidus de différente nature qui pourraient s'avérer difficiles à éliminer par la suite, si on les laisse "sécher et/ou durcir" sur les carreaux, surtout s'ils sont caractérisés par une surface structurée plus ou moins accentuée (par exemple les collections FUSION, PIETRA LAVICA, 5TH AVENUE, etc...). On recommande toujours de choisir le produit de nettoyage avec la plus grande attention pour ne pas altérer irréremdiablement le degré de luisance et de brillante du careau posé.

**Nettoyage des carrelages jointes avec des "Mastics à base de ciment et d'eau".**

Comme on l'a dit, le lavage "après la pose" permet d'éliminer les résidus de béton, les mastics à base de ciments, les nitrates de potassium, les colles et les éventuels résidus superficiels de différente nature. Au cours de cette phase, le carrelage doit être lavé avec des détergents à base d'acides tamponnés au moins 3-4 jours après la pose et au maximum dans les 10 jours. N.B.: Pour les produits caractérisés par des surfaces structurées et/ou antidérapantes (par exemple les collections FUSION, PIETRA LAVICA, PIETRE MILIARI, etc), il est recommandé, vu les aspérités de la structure, de salir le moins possible la surface du carreau au cours de la pose et de bien éliminer les excès de produit utilisé immédiatement après le jointage avec une éponge imbibée d'eau propre. Il est également recommandé d'exécuter la procédure décrite ci-dessous dès que possible et au plus tard avant la période maximale de 3-4 jours indiquée plus haut à compter de l'"après-pose".

**Détergents préconisés:**

Keranet.....	Mapei
Deterdek.....	Fila
Deltaplus.....	Kerakoll
Cement Remover.....	Faber Chimica
Deterpav Professional.....	Madras
Gres Cleaner Extreme Special.....	Priscopio Soluzioni
Solvacid.....	Geal

**Procéder comme suit:**

- Préparer le détergent d'après les indications figurant sur l'étiquette (il est recommandé d'effectuer des essais préliminaires sur des carreaux non posés pour vérifier l'inaltérabilité de la surface des carreaux).
- Mouiller préalablement le carrelage avec de l'eau propre.
- Étaler la solution sur les carreaux en laissant agir quelques minutes.
- Passer la monobrosse en utilisant les disques appropriés (verts pour les surfaces structurées et rouges pour les surfaces non structurées) ou une paille de fer (verte pour les surfaces structurées et rouge/marron pour les surfaces non structurées) en frottant énergiquement la surface des carreaux.
- Rincer abondamment à l'eau propre en aspirant le liquide.

**Nettoyage des carrelages jointes avec des "Mastics époxy"**

Si l'on utilise des mastics époxy, vu qu'ils durcissent rapidement en quelques minutes, le lavage "après la pose" doit être effectué avec des détergents alcalins dans les plus brefs délais en suivant scrupuleusement les indications et les procédures d'utilisation figurant sur l'étiquette.

**Détergents alcalins préconisés:**

Kerapoxy Cleaner.....	Mapei
PS/87.....	Fila
Epoxy Remover.....	Laticrete
Keragel Eco.....	Kerakoll
Wax Remover.....	Faber Chimica
Epoxy.Det.....	Technokolla
Epoxy Cleaner Extreme.....	Periscopio Soluzioni
Eposolu.....	Geal

**Procéder comme suit:**

- Préparer le détergent d'après les indications figurant sur l'étiquette (il est recommandé d'effectuer des essais préliminaires sur des carreaux non posés pour vérifier l'inaltérabilité de la surface des carreaux).
- Mouiller préalablement le carrelage avec de l'eau propre
- Étaler la solution sur les carreaux en laissant agir quelques minutes
- Passer la monobrosse en utilisant les disques appropriés (verts pour les surfaces structurées et rouges pour les surfaces non structurées) ou une paille de fer (verte pour les surfaces structurées et rouge/marron pour les surfaces non structurées) en frottant énergiquement la surface des carreaux.
- Rincer abondamment à l'eau propre en aspirant le liquide

## B) NETTOYAGE QUOTIDIEN

Le nettoyage quotidien peut être réalisé à l'aide de détergents neutres normaux indiqués pour le nettoyage des surfaces en céramique, éventuellement en les diluant dans de l'eau chaude pour en augmenter l'efficacité, en suivant les instructions du producteur sur l'étiquette.

## Hinweise und Empfehlungen für die richtige Reinigung und Pflege des Produktes

Eine gründliche und richtige Reinigung des Keramikproduktes ist von grundlegender Wichtigkeit, um den Glanz und die Schönheit in ursprünglicher Form dauerhaft aufrechtzuerhalten Es wird deshalb geraten, die folgenden Hinweise mit Aufmerksamkeit zu beachten.

## A) REINIGUNG "NACH DER VERLEGUNG" AUF DER BAUSTELLE

**Das anfängliche Reinigen der Fliesen "nach der Verlegung" auf der Baustelle ist eine Phase von grundlegender Wichtigkeit.**

So ist es zu diesem Zeitpunkt möglich, mühelos alle Rückstände der zur Verlegung und/oder Verspachtelung der Fliesenfugen verwendeten Produkte zu entfernen. Es handelt sich um strukturierten Oberfläche gekennzeichneten Fliesen (wie zum Beispiel den Kollektionen FUSION, PIETRA LAVICA, 5TH AVENUE, usw.) "trocknen und/oder austrocknen", sich nur schwer später entfernen lassen. Es wird immer zur höchsten Sorgfalt hinsichtlich der Wahl des Reinigungsmittels geraten, um den Grad des Schimmers und Glanzes der verlegten Fliese nicht unrettbar zu beeinträchtigen.

**Reinigung des mit "Zementspachtel auf Wasserbasis" verfügtun Bodens.**

Wie bereits erwähnt, werden mit der Reinigung "nach der Verlegung" die Rückstände von Zement, Zementspachtel, Salpeter, Kleber und andere eventuelle Rückstände verschiedener Art auf der Oberfläche des Materials entfernt. In dieser Phase muss der Fußboden mit Reinigungsmitteln auf Basis von gepuffertes Säure innerhalb von mindestens 3-4 Tagen und niemals später als 10 Tagen nach der Verlegung gereinigt werden. Anm.: Für die durch strukturierte und/oder rutschfeste Oberflächen gekennzeichneten Produkte (zum Beispiel die Kollektionen FUSION, PIETRA LAVICA, PIETRE MILIARI, usw.) wird im Hinblick auf die Rauhigkeit der Struktur geraten, die Oberfläche der Fliese bei der Verlegung so wenig wie möglich zu verschmutzen und die Rückstände verwendeter Materialien sofort nach der Verfugung mit einem in sauberem Wasser nass gemachten Schwamm zu beseitigen. Außerdem wird geraten, den unten beschriebenen Vorgang sobald wie möglich und in jedem Fall vor den oben genannten 3-4 Tagen maximal "nach der Verlegung" auszuführen.

**Empfohlene Reinigungsmittel:**

Keranet.....	Mapei
Deterdek.....	Fila
Deltaplus.....	Kerakoll
Cement Remover.....	Faber Chimica
Deterpav Professional.....	Madras
Gres Cleaner Extreme Special.....	Priscopio Soluzioni
Solvacid.....	Geal

**Gehen Sie wie folgt vor:**

- Bereiten Sie das Reinigungsmittel gemäß den Angaben auf dem Etikett zu (es wird geraten, vorab Tests auf einer nicht verlegten Fliese durchzuführen, um die Unveränderlichkeit der Oberfläche der Fliese zu prüfen).
- Benässen Sie zuvor den Fußboden mit sauberem Wasser.
- Tragen Sie die Lösung auf die Fliesen auf und lassen Sie sie einige Minuten einwirken.
- Fahren Sie mit der Reinigungsmaschine unter Verwendung geeigneter Scheiben (grün für die strukturierten Oberflächen und rot für die nicht strukturierten) oder einem Schwamm (grün für die strukturierten Oberflächen und rot/braun für die nicht strukturierten) darüber, und reiben Sie energisch über die Oberfläche der Fliesen.
- Wischen Sie mit reichlich sauberem Wasser nach und saugen Sie die Flüssigkeit auf.

**Reinigung des mit "Epoxid-Spachtel" verfügtun Fußbodens**

Bei Verwendung von Epoxid-Spachteln muss die Reinigung „nach der Verlegung“ in Anbetracht ihrer schnellen Aushärtung in wenigen Minuten so schnell wie möglich mit alkalischen Reinigungsmitteln ausgeführt werden, wobei die Hinweise und Verwendungsweise auf dem Etikett genauestens zu beachten sind.

**Empfohlene alkalische Reinigungsmittel:**

Kerapoxy Cleaner.....	Mapei
PS/87.....	Fila
Epoxy Remover.....	Laticrete
Keragel Eco.....	Kerakoll
Wax Remover.....	Faber Chimica
Epoxy.Det.....	Technokolla
Epoxy Cleaner Extreme.....	Periscopio Soluzioni
Eposolu.....	Geal

**Gehen Sie wie folgt vor:**

- Bereiten Sie das Reinigungsmittel gemäß den Angaben auf dem Etikett zu (es wird geraten, vorab Tests auf einer nicht verlegten Fliese durchzuführen, um die Unveränderlichkeit der Oberfläche der Fliese zu prüfen).
- Benässen Sie zuvor den Fußboden mit sauberem Wasser.
- Tragen Sie die Lösung auf die Fliesen auf und lassen Sie sie einige Minuten einwirken.
- Fahren Sie mit der Reinigungsmaschine unter Verwendung geeigneter Scheiben (grün für die strukturierten Oberflächen und rot für die nicht strukturierten) oder einem Schwamm (grün für die strukturierten Oberflächen und rot/braun für die nicht strukturierten) darüber, und reiben Sie energisch über die Oberfläche der Fliesen.
- Wischen Sie mit reichlich sauberem Wasser nach und saugen Sie die Flüssigkeit auf.

## B) TÄGLICHE REINIGUNG

Die gewöhnliche Reinigung kann mit Hilfe normaler neutraler Reinigungsmittel erfolgen, die für die Reinigung von Oberflächen aus Keramik geeignet sind, wobei diese eventuell in warmem Wasser verdünnt werden, um ihre Wirksamkeit zu erhöhen. Beachten Sie die Angaben des Herstellers auf dem Etikett.

## Consejos para la limpieza correcta y el mantenimiento del producto

Effectuar una limpieza correcta y cuidadosa del producto ceramico es fundamental para lograr la duración del brillo y la belleza originales.

Se recomienda seguir con atención las indicaciones siguientes.

## A) LIMPIEZA "DESPUÉS DE LA COLOCACIÓN" EN LA OBRA

**El lavado inicial de las baldosas después de la colocación en la obra es una fase de importancia fundamental.**

Es en este momento que es posible quitar con facilidad de las baldosas todos los residuos de los materiales empleados para la colocación y/o el estucado de las juntas de las baldosas. Se trata de residuos de diferente naturaleza que si se dejan "secar y/o desecar" sobre las baldosas, sobre todo en aquellas con una superficie estructurada mas o menos accentuada (por ejemplo las colecciones FUSION, PIETRA LAVICA, 5TH AVENUE, etc...) podría volverse muy difícil la limpieza posterior. Se recomienda siempre tener el maximo cuidado al elegir el agente de limpieza para no alterar de manera irreversible el grado de brillo y esplendor de la baldosa.

**Limpieza del suelo estucado con "Estucos de cemento a base de agua"**

Como ya indicado, durante el lavado "después de la colocación" se quitan los residuos de cemento, estucos de cemento, salitre, colas y otros posibles residuos superficiales de materiales de diferente naturaleza. Durante esta fase el suelo debe lavarse con detergents a base de acidos que tamponen dentro de por lo menos 3 - 4 días después de la colocación y sin superar mas los 10 días. Nota: Para los productos caracterizados por superficies estructuradas y/o antideslizante (por ejemplo las colecciones FUSION, PIETRA LAVICA, PIETRE MILIARI, etc..) se recomienda, dada la aspereza de la estructura, tratar de ensuciar lo menos posible la superficie de la baldosa durante las fases de colocación y de limpiar bien y enseguida después del estucado, los excesos de material empleando una esponja mojada en agua limpia. Se recomienda realizar el procedimiento abajo descrito lo antes posible y en cualquier caso antes de los mencionados 3 a 4 días como maximo "después de la colocación".

**Detergentes aconsejados:**

Keranet.....	Mapei
Deterdek.....	Fila
Deltaplus.....	Kerakoll
Cement Remover.....	Faber Chimica
Deterpav Professional.....	Madras
Gres Cleaner Extreme Special.....	Priscopio Soluzioni
Solvacid.....	Geal

**Proceder como sigue:**

- Preparar el detergente como se indica en la etiqueta (se aconseja realizar primero pruebas sobre las baldosas no colocadas para comprobar que la superficie de la baldosa no sufre alteraciones)
- Mojar previamente el suelo con agua limpia
- Extender la solución sobre las baldosas dejando que actúe durante algunos minutos.
- Passar la pulidora empleando discos apropiados (verdes para las superficies estructuradas y rojo para las no estructuradas) o una esponja metálica (verde para las superficies estructuradas y roja/marrón para las no estructuradas) fregando con energia la superficie de las baldosas.
- Aclarar con agua limpia en abundancia aspirando el liquido

**Limpieza del suelo estucado con "Estucos epoxidicos"**

Si se emplean estucos epoxidicos, dado que los mismos endurecen con rapidez en pocos minutos, el lavado "después de la colocación" debe realizarse con detergents alcalinos lo antes posible siguiendo taxativamente las indicaciones y procedimientos contenidos en la etiqueta.

**Detergentes alcalinos aconsejados:**

Kerapoxy Cleaner.....	Mapei
PS/87.....	Fila
Epoxy Remover.....	Laticrete
Keragel Eco.....	Kerakoll
Wax Remover.....	Faber Chimica
Epoxy.Det.....	Technokolla
Epoxy Cleaner Extreme.....	Periscopio Soluzioni
Eposolu.....	Geal

**Proceder como sigue:**

- Preparar el detergente como se indica en la etiqueta (se aconseja realizar primero pruebas sobre las baldosas no colocadas para comprobar que la superficie de la baldosa no sufre alteraciones)
- Mojar previamente el suelo con agua limpia
- Extender la solución sobre las baldosas dejando que actúe durante algunos minutos.
- Passar la pulidora empleando discos apropiados (verdes para las superficies estructuradas y rojo para las no estructuradas) o una esponja metálica (verde para las superficies estructuradas y roja/marrón para las no estructuradas) fregando con energia la superficie de las baldosas.
- Aclarar con agua limpia en abundancia aspirando el liquido

## B) LIMPIEZA DIARIA

La limpieza ordinaria se puede realizar con la ayuda de los detergentes neutros normales adecuados para la limpieza de las superficies ceramicas, si es necesario diluyendo en agua caliente para aumentar la eficacia y siempre respetando las instrucciones de la etiqueta de fabricante.

## Рекомендации по правильной очистке изделия и по уходу за ним

Выполнение тщате льной и правильной очистки керамического изделия имеет фундаментально важное значение для сохранения его первоначального глянца и красоты. В связи с этим рекомендуется в точности выполнять следующие инструкции.

## A) ОЧИСТКА ПОСЛЕ УКЛАДКИ НА СТРОЙПЛОЩАДКЕ

**Первичная промывка плитки после укладки на стройплощадке - это важнейший этап.**

Именно в этот момент с плитки можно легко удалить все остатки материалов, используемых для укладки и/или затирки межплиточных швов. Имеются в виду остатки различных материалов, которые, высохнув и/или засохнув на плитке, прежде всего с более или менее выраженной структурированной поверхностью (например, на плитке из коллекций FUSION, PIETAА LAVICA, 5TH AOEHYE и т.д.), в последствии могут стать трудноудаляемыми. При выборе очищающего средства необходимо всегда соблюдать максимальную осторожность во избежание непоправимого изменения степени глянца и блеска уложенной плитки.

**Очистка пола в случае использования цементных затирочных смесей на водной основе**

Как уже упоминалось, при промывке плитки после укладки удаляются остатки цемента, цементной затирочной смеси, селитры, клея и остатки других материалов на ее поверхности. На этом этапе пол должен быть промыт кислотными моющими средствами буферного действия в течение по крайней мере 3-4 дней и ни в коем случае не позже, чем через 10 дней после укладки. ПРИМЕЧАНИЕ: Поскольку поверхность структурированной и/или противоскользящей плитки (например, плитки из коллекций FUSION, PIETAА LAVICA, PIETRE MILIARI, и т.д.) неравная, то следует стараться как можно меньше почать ее при укладке и сразу после затирки хорошо очистить от избытка используемых материалов губкой, смоченной в чистой воде. Кроме того, рекомендуется выполнять нижеописанную процедуру как можно скорее и, в любом случае, не позже, чем через 3-4 дня после укладки.

**Рекомендуемые моющие средства:**

Kerane.....	Mapei
Deterdek.....	Fila
Deltaplus.....	Kerakoll
Cement Remover.....	Faber Chimica
Deterpav Professional.....	Madras
Gres Cleaner Extreme Special.....	Priscopio Soluzioni
Solvacid.....	Geal

**Выполните следующие операции:**

- Подготовьте моющее средство в соответствии с указаниями на этикетке (рекомендуется провести предварительную проверку действия средства на отдельно взятой плитке)
- Предварительно смочите пол чистой водой
- Нанесите раствор на плитку и оставьте его для воздействия на несколько минут
- Обработайте плитку монодисковым полистером, используя соответствующие диски (зеленые для структурированных и красные для неструктурированных поверхностей), или губкой (зеленой в случае структурированных и красной/коричневой в случае неструктурированных поверхностей), энергично протирая ее поверхность.
- Промойте плитку большим количеством воды, а затем соберите ее остатки с помощью устройства для сбора жидкости

**Очистка пола в случае использования эпоксидныз затирочных смесей**

Если для заделки швов использовались эпоксидные затирочные смеси, то, с учетом того, что их затвердение происходит за несколько минут, промывание после укладки должно осуществляться как можно быстрее с помощью щелочных моющих средств с тщательным наблюдением рекомендий и процедур использования, указанных на этикетке.

**Рекомендуемые щелочные моющие средства:**

Kerapoxy Cleaner.....	Mapei
PS/87.....	Fila
Epoxy Remover.....	Laticrete
Keragel Eco.....	Kerakoll
Wax Remover.....	Faber Chimica
Epoxy.Det.....	Technokolla
Epoxy Cleaner Extreme.....	Periscopio Soluzioni
Eposolu.....	Geal

**Выполните следующие операции:**

- Подготовьте моющее средство в соответствии с указаниями на этикетке (рекомендуется провести предварительную проверку действия средства на отдельно взятой плитке, чтобы убедиться в том, что ее поверхность осталась неизменной).
- Предварительно смочите пол чистой водой.
- Нанесите раствор на плитку и оставьте его для воздействия на несколько минут.
- Обработайте плитку монодисковым полистером, используя соответствующие диски (зеленые для структурированных и красные для неструктурированных поверхностей), или губкой (зеленой в случае структурированных и красной/коричневой в случае неструктурированных поверхностей), энергично протирая ее поверхность.
- Промойте плитку большим количеством воды, а затем соберите ее остатки с помощью устройства для сбора жидкости

**В) ПОВСЕДНЕВНАЯ ОЧИСТКА**
Для повседневной очистки рекомендуется использовать обычные нейтральные моющие средства, подходящие для очистки керамических поверхностей, которые для усиления эффективности можно разбавлять горячей водой, в соответствии с инструкциями производителя на этикетке.

# Condizioni generali di vendita

#### APPROVAZIONE

Gli ordini pervenuti sono per noi impegnativi solo dopo la nostra conferma scritta.

#### CONSEGNA

La vendita è sempre franco stabilimento de LA FABBRICA S.p.A.. La merce viaggia a rischio e pericolo dell'acquirente ed ogni nostra responsabilità cessa con la consegna al vettore, nei confronti del quale l'acquirente, effettuate le opportune verifiche, dovrà sporgere eventuali reclami. Le spedizioni, via mare o via terra, concernenti forniture sull'estero, vengono effettuate in base alle condizioni scelte di volta in volta, riportate negli "Incoterms" approvati dalla Camera di Commercio Internazionale.

#### TERMINI DI CONSEGNA

I termini di consegna hanno carattere indicativo, eventuali ritardi nelle consegne, interruzioni, sospensioni totali o parziali delle forniture non daranno diritto ad indennizzi o risarcimento danni.

#### GARANZIE E RECLAMI

I nostri materiali sono garantiti conformi alle norme UNI-DIN-EN attualmente in vigore. La nostra garanzia è limitata ai materiali di sola 1° scelta con tolleranza del 5% (sono esclusi pertanto i materiali di 2°, secondaria, commerciale, 3° e partite occasionali). L'acquirente ha obbligo di verificare la merce in termini di qualità e quantità entro breve tempo dal ricevimento e, in caso di reclamo, dame comunicazione per iscritto entro e non oltre 8 gg dal ricevimento della stessa pena la decadenza di ogni diritto.

Il materiale considerato difettoso dovrà essere tenuto a disposizione di La Fabbrica S.p.A. per le verifiche che riterrà opportuno effettuare; ogni ulteriore azione (restituzione, riparazione o altro) dovrà essere da noi preventivamente autorizzata per iscritto. IlnSTALLAZIONE, anche parziale, del materiale costituisce accettazione incondizionata della conformità dei beni acquistati. I nostri materiali sono da classificarsi fra i prodotti cotti ad alta temperatura e come tali possono presentare differenze fra le dimensioni dichiarate e quelle effettivamente consegnate. Così si dica per le differenze di tono all'interno della medesima partita.

Quanto sopra perciò non potrà essere oggetto di reclamo da parte del committente. L'eventuale comunicazioni di reclami dovrà contenere, oltre i dati di fatturazione, una precisa descrizione del vizio e un adeguato reportage fotografico che lo evidenzi. Nel caso in cui il reclamo risultasse essere infondato, l'acquirente dovrà risarcire La Fabbrica S.p.A. di tutte le spese sostenute per l'accertamento (viaggi, perizie, etc.). La responsabilità de La Fabbrica S.p.A. è strettamente limitata alla sostituzione dei soli pezzi risultati difettosi o alla riparazione, con espressa esclusione di ulteriori specifici indennizzi quali, a titolo indicativo ma non limitativo, per costi di rimozione, attrezzature, macchinari, mancati guadagni per interruzione o sospensione di attività, disagi danni indiretti etc. .

**SOLVE ET REPETE**
Per nessun motivo, ivi compresi vizi o difetti del materiale, il compratore potrà sospendere o ritardare il pagamento del materiale ritirato, salva naturalmente la facoltà di ripetere quando possa dimostrare di avere indebitamente pagato.

#### SOLVE ET REPETE

Per nessun motivo, ivi compresi vizi o difetti del materiale, il compratore potrà sospendere o ritardare il pagamento del materiale ritirato, salva naturalmente la facoltà di ripetere quando possa dimostrare di avere indebitamente pagato.

#### IMBALLO E QUANTITÀ

Il buono stato degli imballi e della loro confezione nonché della quantità consegnata resta accertato con l'accettazione della merce da parte del vettore. Questi, firmando i Documento di Trasporto, si rende responsabile del buono stato del materiale e del quantitativo. Il compratore nel caso si verifichino rotture ed ammanchi dovrà chiedere eventuali danni o risarcimenti al vettore.

**RESI**
Per nessuna ragione l'acquirente potrà restituire il materiale senza nostra espressa preventiva autorizzazione scritta e tutte le spese, compresi i costi di movimentazione nei nostri magazzini della merce resa, sono a carico del Committente.

#### PREZZI

I prezzi riportati sui nostri listini non sono per noi impegnativi. Ci riserviamo il diritto di modificarli prima dell'accettazione dell'ordine. I prezzi pattuiti per ogni singola vendita, si intendono al netto per contanti per consegna franco stabilimento, salvo diversa pattuizione scritta. Se fra la data di ordinazione (anche dopo la conferma d'ordine) e quella di consegna, si verificassero aumenti nei costi delle materie prime, della manodopera, dei combustibili, nelle spese di produzione, di trasporto, etc.. La Fabbrica S.p.A. potrà aumentare il prezzo convenuto dandone comunicazione scritta all'acquirente. Tuttavia qualora tale prezzo superi del 20% quello convenuto al momento dell'ordinazione, l'acquirente potrà recedere dal contratto, notificandoci per iscritto tale sua volontà entro il termine di 10 gg dal ricevimento dell'avviso di aumento del prezzo. In difetto, il nuovo prezzo si intenderà accettato.

#### PAGAMENTI

I pagamenti devono essere effettuati solo presso la nostra sede, eventuali pagamenti fatti ad agenti, rappresentanti, ausiliari di commercio de La Fabbrica S.p.A., non si intendono effettuati finché le relative somme non perverranno a La Fabbrica S.p.A.. Qualsiasi ritardo o irregolarità nel pagamento costituisce grado di insolvenza e offre a La Fabbrica S.p.A. facoltà di sospendere le forniture ed annullare i contratti in corso; esigere l'integrale pagamento di ogni nostro credito ed agire giudizialmente al riguardo, in via esecutiva o cautelativa nonché per il risarcimento danni. La Fabbrica S.p.A. ha comunque diritto "a decorrenza dalla scadenza del pagamento, senza necessità di messa in mora, "agli interessi moratori nella misura prevista del D. LGS. 09-10/2002 nr. 231.

#### SERVIZIO CONSEGNE FINO A SASSUOLO

La Fabbrica S.p.A. fornisce il servizio di consegne presso spedizionieri di Sassuolo e comprensorio per il quale La Fabbrica S.p.A. provvederà ad addebitare un importo di spese in base al peso della spedizione.

#### RISERVATO DOMINIO

Il materiale anche se spedito e regolarmente fatturato resta di nostra proprietà fino al pagamento totale della fornitura medesima come disposto dal Codice Civile sul Riservato Dominio ai sensi degli artt. 1523 e seguenti.

#### CESSIONE DEL CONTRATTO

L'acquirente non può cedere la sua posizione nel contratto od in singoli rapporti obbligatori da questo derivanti senza l'accettazione scritta de La Fabbrica S.p.A.: anche in tale caso l'acquirente rimane comunque solidamente responsabile col cessionario per le obbligazioni cedute.

#### DIVIETO DI ESPORTAZIONE

La Fabbrica S.p.A. è titolare e legittimo detentore di esclusive relative ai marchi al fine di garantire al meglio tali diritti, La Fabbrica S.p.A. effettua le forniture dei propri prodotti mediante un sistema di distribuzione selettiva. Tali forniture sono destinate all'installazione presso l'utente finale. Non viene pertanto autorizzata nessun tipo di rivendita ad altro soggetto commerciale, salvo previa autorizzazione scritta da parte de La Fabbrica S.p.A.. La violazione a quanto sopra riportato può considerarsi equiparata ad un illecito delle proprietà intellettuali e industriali de La Fabbrica S.p.A., con diritto pertanto di quest'ultima di chiederne il sequestro presso qualunque detentore. La Fabbrica si riserva il diritto di procedere giudizialmente nei confronti di chiunque sia coinvolto in rivendite non autorizzate. Salvo accordi in contrario, è fatto divieto all'acquirente di esportare i nostri prodotti oggetto della fornitura.

#### CAMPIONI

I dati figuranti nei documenti illustrativi de La Fabbrica S.p.A., così come le caratteristiche dei campioni e modelli da quest'ultima inviati all'acquirente, hanno carattere di indicazioni approssimative. Queste informazioni non hanno valore impegnativo se non nella misura in cui siano stati espressamente menzionati come tali nell'offerta o nell'accettazione scritta de La Fabbrica S.p.A.

#### FORO COMPETENTE

Il contratto è disciplinato dalla legge italiana, per qualsiasi controversia sarà esclusivamente competente il Foro di Ravenna.

#### APPROVAL

Orders received shall not be binding on us unless confirmed in writing.

#### DELIVERY

Sales are always ex works La FABBRICA S.p.A. Goods shall travel at the purchaser's risk, with our liability ceasing upon delivery to the carrier, against whom the purchaser shall file any claims as may arise following the necessary checks. Shipments sent abroad, either by sea or by ground, shall be governed by the conditions chosen as and when from the Incoterms approved by the International Chamber of Commerce.

#### DELIVERY TERMS

Delivery terms are approximate, and any delays in delivery, or interruptions or total/partial suspension of supplies shall not give rise to any entitlement to compensation or damages.

#### GUARANTEES AND COMPLAINTS

Our materials are guaranteed in compliance with UNI-DIN-EN standards currently in force. Our guarantee only covers 1st-class products, with a fault tolerance of approximately 5% (2nd-class, products with minor tonal imperfections, 3rd-class, and occasional batches are, therefore, not included). The purchaser is required to check the goods in terms of quality and quantity shortly after receipt and any claims relating thereto shall be made in writing, within no more than 8 days of receipt of the goods, under risk of forfeiture of all rights.

The material deemed faulty shall be kept available to La Fabbrica S.p.A. for any checks the latter may consider appropriate to carry out; any further action (refunds, repairs or otherwise) shall be authorised in advance by us in writing. Any material laid, even partly, shall be understood as unconditional acceptance of the conformity of the goods purchased. Our materials are classified as products fired at high temperatures, and as such there may be differences between the rated dimensions and the dimensions of the material actually delivered. The same applies for tonal differences within the same batch. The aforesaid differences shall not, therefore, be used as the basis of a claim by the client. Besides the invoicing details, any claims made shall contain a precise written description of the fault and the appropriate photographic proof showing the fault. In the event that the claim proves to be unfounded, the purchaser shall make good to La Fabbrica S.p.A all the expenses incurred in the assessments (travel, expert reports, etc...).

In the event of liability thereof, La Fabbrica S.p.A. shall simply replace or repair the parts found to be faulty, with the express exclusion of compensation of other specific costs, such as, but not limited to, removal, equipment, machinery, loss of earnings due to disruption or suspension of activities, inconvenience, indirect damages, etc ...

#### SOLVE ET REPETE

On no account may the purchaser suspend or delay payment of collected material, including in the event of faults in the material; this does not affect the right to claim back any payments made unduly.

#### PACKING AND QUANTITY

The good condition of the outer and inner packaging of the material, in addition to the quantities delivered are deemed compliant upon acceptance of the goods by the carrier. Upon signing the delivery document, the latter becomes responsible for the good condition and the quantity of the material. The buyer in the event that or breakages or missing items, the purchaser shall address any claims for damages or compensation to the carrier.

#### RETURNS

On no account may the purchaser return the material without our express prior written consent, in which case all expenses (including handling costs thereof in our warehouses) shall be borne by the Client.

#### PRICES

The prices on our price lists are not binding on us. We reserve the right to alter them before accepting any order. The prices agreed upon for each individual sale are net prices for cash delivery ex works, unless otherwise agreed in writing. If – between the order date and the delivery date (including therein after order confirmation) - increases are experienced in the costs of raw materials, labour, fuel, production, carriage, etc., La Fabbrica S.p.A shall increase the price agreed upon, giving written notice thereof to the purchaser. However, if that price increase exceeds 20% of that agreed upon ordering, the purchaser may withdraw from the agreement, notifying us in writing of this intention within 10 days of receipt of notification of the price increase. Failing that, the new price shall be deemed accepted.

#### PAYMENTS

Payments shall be made solely to us, and any payments made to agents, representatives, or sales assistants for La Fabbrica S.p.A, shall not be construed as made until the amounts are received by La Fabbrica S.p.A.. Any delays in payment or non-compliant payments shall be deemed failure to pay and shall result in La Fabbrica S.p.A being entitled to suspend deliveries and terminate agreements in place, demand full payment of all accounts receivable and take legal action to obtain such payment, including therein enforcement or interim measures, and likewise seek compensation for damage. La Fabbrica S.p.A. is nevertheless entitled to charge the interest due on arrears at the rate envisaged in Italian Legislative Decree n. 231 dated 9/10/2002 . “as of the payment due date, without any formal notice,”

#### DELIVERY SERVICE TO SASSUOLO

La fabbrica S.p.A. offers a delivery service to the carriers based in the town of Sassuolo and the surrounding district, for which La Fabbrica S.p.A. charges rates based on the shipment weight.

#### RETENTION OF OWNERSHIP

Even if dispatched and duly invoiced, the material shall remain our property until full payment thereof, as provided for in the Italian Civil Code on the retention of ownership, pursuant to Articles 1523 et seq.

#### ASSIGNMENT

The purchaser may not assign its role within the agreement or in individual binding relationships arising therefrom without written agreement from La Fabbrica S.p.A, in the event of an agreed assignment, the purchaser nevertheless remains jointly liable with the assignee for the assigned obligations.

#### NO EXPORTING

La Fabbrica S.p.A is the owner and legitimate holder of exclusive rights over the trademarks. In order to best guarantee such rights, La Fabbrica s.p.a. shall supply its products through a selective distribution system. These supplies are intended for installation on the end user's premises. No resale to other business entities is, therefore, allowed, unless prior written permission is given by La Fabbrica S.p.A. Any breach of the above may be deemed tantamount to misuse of the intellectual and industrial property of La Fabbrica S.p.a., with the latter therefore entitled to request seizure of such infringing material wherever it is held. La Fabbrica S.p.A. reserves the right to take legal action against anyone involved in unauthorised resales. Unless agreed otherwise, the purchaser is forbidden to export the products we have supplied.

#### SAMPLES

The data shown in the literature supplied by La Fabbrica S.p.A., as well as the features of samples and models sent thereby to the purchaser, are provided as an approximate guide. This information is not binding unless expressly mentioned in the offer or in the written acceptance provided by La Fabbrica S.p.A.

#### COMPETENT AUTHORITY

The present agreement is governed by Italian law and any dispute arising in relation hereto shall be settled solely by the court of Ravenna.

#### CONDITIONS GÉNÉRALES DE VENTE

#### APPROBATION

Les commandes qui nous sont parvenues ne deviennent contraignantes qu’après notre confirmation écrite.

#### LIVRAISON

La vente est toujours réalisée départ usine LA FABBRICA S.p.A.. La marchandise est transportée aux risques et périls de l’acheteur et notre responsabilité, quelle qu'elle soit, cesse au moment de la remise au transporteur, à l'encontre de qui l’acheteur devra adresser d’éventuelles réclamations, après avoir effectué les vérifications opportunes. Les expéditions maritimes ou terrestres concernant les fournitures à l'étranger sont effectuées en fonction des conditions choisies cas par cas, indiquées dans les "Incoterms" approuvés par la Chambre de Commerce Internationale.

#### DÉLAIS DE LIVRAISON

Les délais de livraison ont un caractère indicatif ; d’éventuels retards des livraisons, interruptions, suspensions totales ou partielles des fournitures ne donneront droit à aucun dédommagement ni indemnisation.

#### GARANTIES ET RÉCLAMATIONS

Notre matériel est garanti conforme aux normes UNI-DIN-EN actuellement en vigueur. Notre garantie est limitéee aux matériaux de 1er choix avec une tolérance de 5 % (sont donc exclus le matériel de 2e choix, secondaire, commercial, de 3e choix et les lots occasionnels). L’acheteur a l’obligation de vérifier la marchandise en termes de qualité et de quantité, dans un délai court à compter de la réception et il devra communiquer toute réclamation éventuelle par écrit dans un délai maximum de 8 jours à compter de la réception de cette dernière sous peine de la déchéance de tout droit. Le matériel considéré défectueux devra rester à la disposition de La Fabbrica S.p.A. pour les vérifications quelle jugera opportunes ; toute action ultérieure (restitution, réparation ou autre) devra être préalablement autorisée par écrit par nos soins. L'installation, même partielle, du matériel constitue l’acceptation inconditionnée de la conformité des biens achetés. Notre matériel doit être classé parmi les produits cuits à haute température et en tant que tel il peut présenter des différences entre les dimensions déclarées et celles effectivement livrées. Il en est de même pour les différences de ton à l’intérieur d’un même lot. Ce qui précède ne pourra donc pas faire l’objet d’une réclamation de la part du client. L'éventuelle communication de réclamations devra contenir, outre les données de facturation, une description précise du vice et un reportage photographique susceptible de l’illustrer de façon adéquate. Si la réclamation est sans fondement, l’acheteur devra dédommager La Fabbrica S.p.A. e remboursant toutes les dépenses encourues pour les contrôles (déplacements, expertises, etc...). La responsabilité de La Fabbrica S.p.A. est strictement limitée au remplacement des pièces défectueuses ou à la réparation, en excluant expressément toute indemnisation spécifique ultérieure comme, à titre indicatif non contraignant, pour les coûts d'enlèvement, les équipements, les machines, les manque à gagner suite à une interruption ou à la suspension d’ une activité, les situations de gêne, les dommages indirects, etc.

**SERVICE DE LIVRAISONS JUSQU’À SASSUOLO**
La fabbrica S.p.A. fournit le service de livraison auprès de transporteurs de Sassuolo et sa région pour leuel La Fabbrica S.p.A. facturera une note de frais en fonction du poids de l'expédition.

**RÉSERVE DE PROPRIÉTÉ**
Le matériel, bien qu’il ait été expédié et régulièrement facturé, reste notre propriété jusqu’au paiement total de la fourniture conformément au Code Civil sur la Réserve de Propriété aux termes des art. 1523 et suivants.

#### CESSION DU CONTRAT

L’acheteur ne peut céder sa position dans le contrat ou dans des rapports obligatoires individuels dérivant de ce dernier sans l’acceptation écrite de la part de La Fabbrica S.p.A. : dans ce cas aussi, l’acheteur reste toujours solidairement responsable avec le cessionnaire en ce qui concerne les obligations cédées.

#### INTERDICTION D’EXPORTATION

La Fabbrica s.p.a. est propriétaire et détenteur légitime d'exclusivités relatives aux marques. Afin de garantir au mieux ces droits, La Fabbrica S.p.a. fournit ses produits moyennant un système de distribution sélective. Ces fournitures sont destinées à l’installation chez l’ utilisateur final. Ainsi, aucun type de revente à un autre sujet commercial n’est autorisé, sans l’autorisation écrite préalable de La Fabbrica S.p.A.. La violation de ce qu’on vient dénoncer peut être considérée comme un usage illicite des propriétés intellectuelles et industrielles de La Fabbrica S.p.A., avec le droit pour cette dernière d’en demander la saisie auprès de tout détenteur. La Fabbrica se réserve le droit de saisir la justice contre toute personne impliquée dans des reventes non autorisées. Sauf accord contraire, il est interdit à l’acheteur d’exporter nos produits constituant la fourniture.

#### SOLVE ET REPETE

Pour aucune raison, y compris les vis ou les défauts du matériel, l’acheteur ne pourra suspendre ou retarder le paiement du matériel retiré, sans préjudice naturellement de la faculté d’exiger lorsqu’il est en mesure de démontrer le paiement indu.

#### EMBALLAGE ET QUANTITÉ

Le bon état des emballages et de la quantité livrée est établi avec l’acceptation de la marchandise de la part du transporteur. Celui-ci, en signant le Document de Transport, devient responsable du bon état du matériel et de la quantité. En cas de rupture ou de parties manquantes, l’acheteur devra demander l’éventuel remboursement ou dédommagement au transporteur.

#### RETOURS

L’acheteur ne pourra restituer le matériel sans notre autorisation préalable expresse, pour aucune raison, et toutes les dépenses, y compris les coûts de manutention, à l’intérieur de nos entrepôts, de la marchandise rendue sont à la charge du Client.

#### PRIX

Les prix indiqués sur nos tarifs ne sont pas contraignants pour nous. Nous nous réservons le droit de les modifier avant l’acceptation de la commande. Les prix convenus pour chaque vente, sont réputés nets pour les paiements au comptant pour livraison départ usine, sauf accord contraire écrit. Si entre la date de la commande (également après la confirmation de commande) et la date de livraison, le prix des matières premières, de la main-d’œuvre, des combustibles, des frais de production, de transport, etc. devait subir des hausses, La Fabbrica S.p.A. pourra augmenter le prix convenu en le communiquant par écrit à l’acheteur. Toutefois, si ce prix est supérieur de 20 % au prix convenu à la commande, l’acheteur pourra résilier le contrat, en nous notifiant par écrit sa volonté dans un délai de 10 jours à compter de la réception de l’avis d’augmentation du prix. A défaut, le nouveau prix sera réputé accepté.

#### PAIEMENTS

Les paiements doivent être effectués exclusivement en notre siège, d’éventuels paiements effectués aux agents, aux représentants et aux auxiliaires de commerce de La Fabbrica S.p.A., ne seront réputés effectués que lorsque la somme correspondante parviendra à La Fabbrica s.p.A.. Tout retard ou irrégularité de paiement constitue une insolvabilité et laisse à La Fabbrica S.p.a. la faculté de suspendre les fournitures et d’annuler les contrats en cours, d’exiger le paiement intégral de l’ensemble de notre créance et de saisir les tribunaux à ce propos, à titre exécutif ou conservatoire, ainsi que pour le remboursement des dommages. La Fabbrica S.p.A. a quoi qu’il en soit le droit « à compter de l’échéance du paiement, sans nécessité de mise en demeure » de percevoir des intérêts moratoires dans la mesure prévue par le Décret Législatif italien n°09-10/2002 n° 231.

**SERVICE DE LIVRAISONS JUSQU’À SASSUOLO**
La fabbrica S.p.A. fournit le service de livraison auprès de transporteurs de Sassuolo et sa région pour leuel La Fabbrica S.p.A. facturera une note de frais en fonction du poids de l'expédition.

**RÉSERVE DE PROPRIÉTÉ**
Le matériel, bien qu’il ait été expédié et régulièrement facturé, reste notre propriété jusqu’au paiement total de la fourniture conformément au Code Civil sur la Réserve de Propriété aux termes des art. 1523 et suivants.

#### CESSION DU CONTRAT

L’acheteur ne peut céder sa position dans le contrat ou dans des rapports obligatoires individuels dérivant de ce dernier sans l’acceptation écrite de la part de La Fabbrica S.p.A. : dans ce cas aussi, l’acheteur reste toujours solidairement responsable avec le cessionnaire en ce qui concerne les obligations cédées.

**INTERDICTION D’EXPORTATION**
La Fabbrica s.p.a. est propriétaire et détenteur légitime d'exclusivités relatives aux marques. Afin de garantir au mieux ces droits, La Fabbrica S.p.a. fournit ses produits moyennant un système de distribution sélective. Ces fournitures sont destinées à l’installation chez l’ utilisateur final. Ainsi, aucun type de revente à un autre sujet commercial n’est autorisé, sans l’autorisation écrite préalable de La Fabbrica S.p.A.. La violation de ce qu’on vient dénoncer peut être considérée comme un usage illicite des propriétés intellectuelles et industrielles de La Fabbrica S.p.A., avec le droit pour cette dernière d’en demander la saisie auprès de tout détenteur. La Fabbrica se réserve le droit de saisir la justice contre toute personne impliquée dans des reventes non autorisées. Sauf accord contraire, il est interdit à l’acheteur d’exporter nos produits constituant la fourniture.

#### SOLVE ET REPETE

Pour aucune raison, y compris les vis ou les défauts du matériel, l’acheteur ne pourra suspendre ou retarder le paiement du matériel retiré, sans préjudice naturellement de la faculté d’exiger lorsqu’il est en mesure de démontrer le paiement indu.

#### EMBALLAGE ET QUANTITÉ

Le bon état des emballages et de la quantité livrée est établi avec l’acceptation de la marchandise de la part du transporteur. Celui-ci, en signant le Document de Transport, devient responsable du bon état du matériel et de la quantité. En cas de rupture ou de parties manquantes, l’acheteur devra demander l’éventuel remboursement ou dédommagement au transporteur.

#### RETOURS

L’acheteur ne pourra restituer le matériel sans notre autorisation préalable expresse, pour aucune raison, et toutes les dépenses, y compris les coûts de manutention, à l’intérieur de nos entrepôts, de la marchandise rendue sont à la charge du Client.

#### TRIBUNAL COMPÉTENT

Le contrat est réglementé par la loi italienne ; les parties reconnaissent la compétence exclusive du Tribunal de Ravenne en cas de controverse.

#### ALLGEMEINE VERKAUFSBEDINGUNGEN

#### GENEHMIGUNG

Die bei uns eingegangenen Bestellungen sind nur nach unserer schriftlichen Bestätigung für uns verbindlich.

#### LIEFERUNG

Der Verkauf erfolgt immer frei Werk von LA FABBRICA S.p.A.. Die Ware wird auf Kosten und Gefahr des Käufers transportiert und jegliche Haftung unsererseits endet mit der Übergabe an den Spediteur, dem gegenüber der Käufer nach Vornahme der entsprechenden Kontrollen eventuelle Reklamationen vorbringen muss. Die Versendung auf dem Meeres- oder Landweg, hinsichtlich Lieferungen ins Ausland, erfolgen auf Grundlage der jeweils gewählten Bedingungen, die in den von der Internationalen Handelskammer genehmigten "Incoterms" aufgeführt sind.

#### LIEFERFRISTEN

Die Lieferfristen sind Richtwerte und eventuelle Verzögerungen bei den Lieferungen, Unterbrechungen, vollständige oder teilweise Einstellungen der Lieferungen begründen kein Recht auf Entschädigungen oder Schadensersatz.

#### GARANTIE UND REKLAMATIONEN

Unsere Materialien werden gemäß den derzeit geltenden Bestimmungen UNI-DIN-EN garantiert. Unsere Garantie beschränkt sich nur auf die Materialien 1. Wahl mit einer Toleranz von 5% (deshalb sind die Materialien 2. Wahl, sekundärer und 3. Wahl sowie Restposten ausgeschlossen). Der Käufer hat die Pflicht, die Ware hinsichtlich der Qualität und Menge innerhalb kurzer Zeit nach dem Erhalt zu prüfen und bei Reklamationen diese schriftlich innerhalb von 8 Tagen nach Erhalt melden. Anderenfalls verfallen jegliche Ansprüche. Das als mangelhaft angesehene Material muss der Firma La Fabbrica S.p.A. für die Kontrollen zur Verfügung gehalten werden, deren Durchführung diese für angebracht hält. Jegliche weiteren Handlungen (Rückgabe, Reparatur oder anderes) müssen von uns vorab schriftlich genehmigt werden. Der auch nur teilweise Einbau des Materials bildet eine bedingungslose Annahme der Konformität der erworbenen Waren. Unsere Materialien sind unter die bei hoher Temperatur gebrannten Produkte einzuordnen und als solche können sie Unterschiede bei den aufgeführten Abmessungen und denen effektiv gelieferten aufweisen. Gleiches gilt auch für die Unterschiede im Farbton innerhalb der gleichen Partie. Obiges kann deshalb kein Gegenstand einer Reklamation seitens des Auftraggebers sein. Die eventuelle Meldung von Reklamationen muss außer den Rechnungsdaten eine genaue Beschreibung des Mangels und eine geeignete fotografische Dokumentation enthalten, die diesen zeigt. Sollte sich die Reklamation als unbegründet herausstellen, muss der Käufer der Firma La Fabbrica S.p.A. alle Kosten ersetzen, die für die Kontrolle aufgewandt wurden (Reisen, Gutachten, usw.). Die Haftung der Firma La Fabbrica S.p.A. ist eng auf den Ersatz oder die Reparatur allein der Stücke begrenzt, die sich als defekt herausgestellt haben. Ausdrücklich ausgeschlossen sind dabei weitere spezifische Entschädigungen, wie rein Beispielsweise aber nicht ausschließlich für Kosten der Entfernung, Ausrüstungen, Maschinen, entgangenen Gewinn durch Unterbrechung oder Einstellung der Tätigkeit, Nachteile und indirekte Schäden, usw.

**LIEFERSERVICE BIS NACH SASSUOLO**
Die Firma La Fabbrica S.p.A. bietet einen Lieferservice über Spediteure in Sassuolo und im Umkreis, für den die Firma La Fabbrica S.p.A. einen Kostenbetrag auf Grundlage des Gewichts der Spedition in Rechnung stellt.

#### EIGENTUMSVORBEHALT

Das Material bleibt, auch wenn es ausgeliefert und ordnungsgemäß in Rechnung gestellt wird, bis zur vollständigen Bezahlung dieser Lieferung gemäß den Bestimmungen des ital. ZGB zum Eigentumsvorbehalt laut der Art. 1523 ff. unser Eigentum.

#### ABTRETUNG DES VERTRAGS

Der Käufer darf seine Position im Vertrag oder in einzelnen, sich aus diesem ergebenden obligatorischen Geschäftsbeziehungen ohne schriftliche Zustimmung der Firma La Fabbrica S.p.A. nicht abtreten: auch in diesem Fall bleibt der Käufer dennoch mit dem Abtretungsübnehmer gesamtschuldnerisch für die abgetretenen Verpflichtungen haftbar.

#### AUSFUHRVERBOT

Die Firma La Fabbrica S.p.A. ist Inhaber und rechtmäßiger Besitzer von Exklusivrechten in Bezug auf die Marken. Um diese Rechts bestmöglich zu garantieren, führt die Firma La Fabbrica S.p.A. die Lieferungen ihrer Produkte über ein selektives Vertriebssystem aus. Diese Lieferungen sind für den Einbau beim Endanwender bestimmt. Deshalb wird keinerlei Art Weiterverkauf an eine andere Geschäftsperson gestattet, es sei denn mit einer vorherigen schriftlichen Genehmigung seitens der Firma La Fabbrica S.p.A.. Die Verletzung obiger Festlegungen kann als einem widerrechtlichen Gebrauch des geistigen und gewerblichen Eigentumsrechte der Firma La Fabbrica S.p.A. angesehen werden, womit letztere das Recht hat, die Beschlagnahme bei einem beliebigen Besitzer zu fordern. Die Firma La Fabbrica S.p.A. behält sich vor, gerichtlich gegen jeden vorzugehen, der in unbefugte Weiterverkäufe verwickelt ist. Vorbehaltlich gegenteiliger Vereinbarungen ist es dem Käufer verboten, unsere Produkte, die Gegenstand der Lieferung sind, zu exportieren.

#### SOLVE ET REPETE

Aus keinem Grund, d.h. einschließlich Mängeln oder Defekten des Materials, darf der Käufer die Bezahlung des abgeholten Materials einstellen oder verspäten, es sei denn natürlich der Möglichkeit einer Rückforderung, wenn er nachweisen kann, dass er einen nicht geschuldeten Betrag gezahlt hat.

#### VERPACKUNG UND MENGE

Der gute Zustand der Verpackungen und ihrer Packung sowie der gelieferten Menge gilt mit Annahme der Ware durch den Spediteur als festgestellt. Dieser wird durch Unterzeichnung des Lieferscheins für den guten Zustand des Materials und die Menge verantwortlich. Sollte es zu Brüchen und Fehlmengen kommen, muss der Käufer eventuelle Schäden oder Schadensersatz beim Spediteur einfordern.

#### RÜCKGABEN

Aus keinem Grund darf der Käufer das Material ohne unsere ausdrückliche vorherige schriftliche Genehmigung zurückgeben und alle Kosten, einschließlich der für den Transport der zurückgegebenen Ware in unsere Lager gehen zu Lasten des Auftraggebers.

#### GERICHTSSTAND

Der Vertrag wird vom italienischen Gesetz geregelt, für jegliche Streitsachen ist ausschließlich der Gerichtsstand Ravenna zuständig.

#### PREISE

Die in unseren Listen aufgeführten Preise sind für uns nicht verbindlich. Wir behalten uns vor, sie vor Annahme der Bestellung zu verändern. Die für jeden einzelnen Verkauf vereinbarten Preise verstehen sich vorbehaltlich einer anderen schriftlichen Vereinbarung netto, bar für die Lieferung frei Werk. Sollte es zwischen dem Datum der Bestellung (auch nach der Auftragsbestätigung) und dem der Lieferung zu einem Anstieg der Kosten für Rohstoffe, Arbeitskräfte, Brennstoffe, Produktions- oder Transportkosten, usw. kommen, kann die Firma La Fabbrica S.p.A. den vereinbarten Preis erhöhen und macht dem Käufer davon schriftlich Mitteilung. Sollte dieser Preis jedoch den zum Zeitpunkt der Bestellung vereinbarten um 20% übersteigen, kann der Käufer den Vertrag durch schriftlich Mitteilung seines Willens innerhalb einer Frist von 10 Tagen ab dem Erhalt der Mitteilung über die Preiserhöhung auflösen. Anderenfalls versteht sich der neue Preis als akzeptiert.

#### ZAHLUNGEN

Die Zahlungen dürfen nur am unserem Sitz erfolgen. Eventuelle an Agenten, Vertreter oder Handelshelfer der Firma La Fabbrica S.p.A. vorgenommene Zahlungen verstehen sich als nicht erfolgt, bis die entsprechenden Beträge der Firma La Fabbrica S.p.A. zugehen. Jegliche Verspätungen oder Unregelmäßigkeiten bei der Bezahlung bilden Zahlungsunfähigkeit und geben der Firma La Fabbrica die Möglichkeit, die Lieferungen einzustellen und die laufenden Verträge zu kündigen, die vollständige Zahlung aller unserer Forderungen zu fordern und diesbezüglich gerichtlich zur Beitreibung oder vorsichtshalber sowie zum Ersatz des Schadens vorzugehen. Die Firma La Fabbrica hat in jedem Fall das Recht, bei Ablauf der Zahlungsfrist, ohne Notwendigkeit einer Mahnung", auf Verzugszinsen in dem von der Rechtsverordnung 09-10/2002 Nr. 23

# Condizioni generali di vendita

## Condiciones generales de venta

Logo de FABBRICA S.p.A.

#### APROBACIÓN

Los pedidos recibidos constituyen fuente de obligaciones para nosotros solo después de nuestra confirmación escrita.

#### ENTREGA

La venta se efectúa siempre en fábrica, en establecimiento de LA FABBRICA S.p.A.. La mercancía viaja bajo la responsabilidad del comprador y toda nuestra responsabilidad cesa con la entrega al transportista, respecto del cual el comprador —una vez efectuadas las respectivas verificaciones- podrá presentar eventuales reclamos. Los transportes relativos a suministros para el extranjero, por vía marítima o por vía aérea, se efectúan en base a las condiciones establecidas vez por vez, señaladas en los “Incoterms” aprobados por la Cámara de Comercio Internacional.

#### PLAZOS DE ENTREGA

Los plazos de entrega tienen un valor de carácter general; eventuales retrasos, interrupciones o suspensiones totales o parciales de los suministros no otorgan derecho a indemnizaciones ni resarcimientos de daños.

#### GARANTÍAS Y RECLAMOS

Nuestros materiales son garantizados de conformidad con lo establecido por las normas UNI-DIN-EN actualmente vigentes. Nuestra garantía queda limitada solo a los materiales de 1ª selección con tolerancia del 5 % (quedan excluidos, por lo tanto, los materiales de 2ª, secundaria, comercial, 3ª y partidas ocasionales). El comprador tiene la obligación de verificar la mercancía en términos de calidad y cantidad dentro de breve tiempo desde la recepción y, en caso de reclamo, enviar comunicación por escrito dentro del plazo máximo de 8 días a contar de la recepción de la misma, so pena de extinción de todo posible derecho. El material considerado como defectuoso deberá ser retenido por La Fabbrica S.p.A. para efectuar las verificaciones que estimará conveniente; toda ulterior acción (restitución, reparación u otra) deberá ser por nosotros previamente autorizada por escrito. La instalación del material, incluso parcial, constituye aceptación incondicional de la conformidad de los bienes adquiridos. Nuestros materiales deben ser clasificados entre los productos cocidos a alta temperatura y, como tales, pueden presentar diferencias entre las dimensiones declaradas y aquellas efectivamente entregadas. Lo mismo vale para las diferencias de tonalidad en el ámbito de una misma partida. Por lo tanto, lo anterior no podrá ser objeto de reclamo por parte del cliente. La eventual comunicación de reclamos deberá incluir, además de los datos de facturación, una precisa descripción del vicio o defecto y una adecuada información fotográfica que lo deje en evidencia. En caso de que el reclamo carezca de fundamento, el comprador deberá indemnizar a La Fabbrica S.p.A. por todos los gastos efectuados relativos a la verificación (viajes, peritaciones, etc.). La responsabilidad de La Fabbrica S.p.A. queda estrictamente limitada a la sustitución solo de las piezas que resulten ser defectuosas o a su reparación, con expresa exclusión de ulteriores específicas indemnizaciones tales como, a título indicativo pero no limitativo, por costos de remoción, herramientas, maquinaria, lucro cesante por interrupción o suspensión de actividades, inconvenientes, daños indirectos, etc.

#### PAGAR Y RECLAMAR

Por ningún motivo, incluidos vicios o defectos del material, el comprador podrá suspender o retardar el pago del material retirado, sin perjuicio naturalmente de la facultad de reclamar restitución en caso de demostrar el hecho de haber pagado indebidamente.

#### EMBALAJE Y CANTIDAD

El buen estado de los embalajes y de su presentación, así como la cantidad entregada, quedan verificados con la aceptación de la mercancía por parte del transportista. Este último, firmando el documento de transporte, se hace responsable del buen estado del material y de su cantidad. En caso de verificarse roturas o faltas de material, el comprador, deberá pedir eventuales resarcimientos al transportista.

#### DEVOLUCIONES

Por ningún motivo el comprador podrá restituir el material sin nuestra expresa y previa autorización escrita y todos los gastos, incluidos los costos de movimiento en nuestros almacenes de la mercancía restituida, quedan a cargo del cliente.

#### PRECIOS

Los precios señalados en nuestras listas no son obligatorios para nosotros. Nos reservamos el derecho de modificarlos antes de aceptar el pedido. Los precios pactados para cada venta se entienden al neto, en efectivo y para entrega en fábrica, salvo diferente pacto escrito. Si entre la fecha de ejecución del pedido (también después de la confirmación de pedido) y aquella de entrega, si verificaran aumentos en los costos de las materias primas, de la mano de obra, de los combustibles, en los gastos de producción, de transporte, etc., La Fabbrica S.p.A. podrá aumentar el precio pactado mediante comunicación escrita dirigida al comprador. No obstante, en caso de que tal precio supere en un 20 % aquel pactado en el momento de efectuar el pedido, el comprador podrá desistirse del contrato, notificándonos por escrito tal voluntad dentro del plazo de 10 días a contar de la recepción del aviso de aumento del precio. En caso contrario el nuevo precio se considerará como aceptado.

#### PAGOS

Los pagos deben ser efectuados solo en nuestra sede. Eventuales pagos hechos a agentes, representantes o auxiliares de comercio de La Fabbrica S.p.A. se entienden efectuados solo cuando las respectivas sumas llegan a poder de La Fabbrica S.p.A.. Cualquier retardo o irregularidad en el pago constituye insolvencia y ofrece a La Fabbrica S.p.A. facultad de suspender los suministros y anular los contratos en curso; exigir el pago integral de cada uno de nuestros créditos y actuar judicialmente al respecto, en vía ejecutiva o cautelar, así como para el resarcimiento cautelar de los daños. En todo caso, La Fabbrica S.p.A. tiene igualmente derecho “a contar del vencimiento del pago, sin necesidad de puesta en mora”, a los intereses moratorios en la medida prevista por el D. LGS. n.º 231 de 09/10/2002.

#### SERVICIO DE ENTREGAS HASTA SASSUOLO

La Fabbrica S.p.A. proporciona el servicio de entregas a través de transportistas de Sassuolo y su distrito, para lo cual la empresa procederá a cargar un importe por gastos en función del peso del material enviado.

#### RESERVA DE DOMINIO

No obstante su envío y su válida facturación, el material continua siendo de nuestra propiedad hasta el pago total del suministro mismo, tal como establece el Código Civil respecto de La Reserva de Dominio, de conformidad con lo dispuesto por los art. 1523 y siguientes.

#### CESIÓN DEL CONTRATO

El comprador no puede ceder su posición en el contrato ni en específicas relaciones obligacionales que de él deriven sin previa aceptación escrita de parte de La Fabbrica S.p.A.: incluso en tal caso, igualmente el comprador continúa siendo solidariamente responsable con el cesionario respecto de las obligaciones cedidas.

#### PROHIBICIÓN DE EXPORTACIÓN

La Fabbrica S.p.A. es titular y legítimo poseedor de exclusividad respecto de las marcas. A fin de garantizar al máximo tales derechos, La Fabbrica S.p.A. efectúa el suministro de sus propios productos mediante un sistema de distribución selectiva. Tales suministros están destinados a su instalación por parte del usuario final. Por lo tanto, no se autoriza ningún tipo de reventa a otros operadores comerciales, salvo previa autorización escrita por parte de La Fabbrica S.p.A.. La violación de lo antes señalado puede considerarse como equivalente a un uso ilícito de las propiedades intelectuales e industriales de La Fabbrica S.p.A., por lo tanto, con derecho de parte de esta última a solicitar su embargo a cualquier utilizador de las mismas. La Fabbrica S.p.A. se reserva el derecho de proceder judicialmente en contra de quienquiera que participe en reventas no autorizadas. Salvo acuerdos en contrario, queda prohibido al comprador la exportación de nuestros productos objeto del suministro.

#### MUESTRAS

Nos datos que aparecen en los documentos ilustrativos de La Fabbrica S.p.A., así como las características de las muestras y modelos de esta última enviados al comprador, tienen el carácter de indicaciones generales y aproximativas. Estas informaciones no constituyen fuente de obligaciones sino en la medida en que hayan sido expresamente mencionadas como tales en la oferta o en la aceptación escrita por parte de La Fabbrica S.p.A..

#### FORO COMPETENTE

El contrato queda sometido a las disposiciones de la ley italiana y respecto de cualquier controversia será exclusivamente competente el Foro de Ravenna.

## Общие условия продажи

Logo de FABBRICA S.p.A.

#### ПОДТВЕРЖДЕНИЕ ЗАКАЗА

Поступившие нам заказы считаются принятыми только после нашего письменного подтверждения.

#### ПОСТАВКА

Продажа осуществляется всегда на условиях франко завод компании LA FABBRICA S.p.A.. Товар перевозится на страх и риск покупателя. Любая ответственность с нашей стороны прекращается в момент передачи товара грузоперевозчику, которому покупатель должен предъявлять возможные претензии после выполнения надлежащей проверки. Зарубежные перевозки морским или сухопутным путем будут осуществляться на условиях, выбранных в каждом конкретном случае, предусмотренных правилами Инкотермс, утвержденными Международной торговой палатой.

#### СРОКИ ПОСТАВКИ

Сроки поставки являются ориентировочными. Возможная задержка поставки, ее приостановка, частичное или полное прекращение не дают права на возмещение убытков или компенсацию за ущерб.

#### ГАРАНТИЯ И ПРЕТЕНЗИИ

Наши материалы гарантированы на соответствие действующим в настоящее время нормам UNI-DIN-EN. Наша гарантия распространяется только на материал первого сорта с допуском 5% (поэтому, гарантия не покрывает материал второго, второго, коммерческого, третьего сорта и случайные партии). Покупатель обязан проверить качество и количество товара сразу после его получения и при возникновении претензий заявить о них в письменной форме не позднее 8 дней с момента получения товара, в противном случае любое право отменяется. Материал, который считается дефектным, необходимо оставить в распоряжении компании La Fabbrica S.p.A. для выполнения контроля, который она сочтет необходимым. Любое другое действие (возврат, ремонт или иное) должно быть предварительно разрешено нашей компанией в письменном виде. Даже частичная укладка материала является безоговорочным одобрением соответствия приобретенного товара. Изделия нашего производства относятся к обожженной при высокой температуре продукции, поэтому, заявленные и реальные размеры поставленных изделий могут отличаться. Это касается и различий в оттенках изделий из одной и той же партии. В связи с этим размеры и оттенки не могут стать предметом рекламации со стороны заказчика. При выставлении претензии необходимо не только указать приведенные в инвойсе данные, но и приложить точное описание изъянов и соответствующий фотоматериал, наглядно иллюстрирующий их. Если претензия окажется необоснованной, то покупатель обязан возместить компании La Fabbrica S.p.A. все расходы, понесенные ею для проведения контроля (поездки, экспертизы и т.д..). В любом случае ответственность компании La Fabbrica S.p.A. ограничиваются заменой или ремонтом лишь только дефектных изделий, категорически исключается другое дополнительное возмещение, например, в качестве неисчерпывающего перечня примеров - расходы на удаление материала, оборудование, упущенная прибыль в связи с приостановкой или прекращением деятельности, за неудобство, косвенные убытки и тд.

#### SOLVE ET REPETE (сначала оплата, затем требования)

Ни по какой причине, в том числе из-за изъянов или дефектов материала, покупатель не имеет права приостанавливать или задерживать оплату вывезенного материала, при этом подразумевается, что покупатель имеет право требовать возмещения, если он сможет доказать факт неправомерного взимания оплаты.

#### УПАКОВКА И КОЛИЧЕСТВО

Перевозчик обязан проконтролировать груз по количеству и целостности упаковки при приемке товара. Подписав транспортную накладную, перевозчик несет ответственность за сохранность материала и за его количество. В случае обнаружения повреждений и недостачи покупатель должен предъявлять перевозчику возможные претензии о возмещении ущерба за понесенные убытки.

#### ВОЗВРАТ ТОВАРА

Покупатель не может ни на каком основании осуществлять возврат товара без нашего предварительного письменного согласия. При этом будут отнесены на счет заказчика все расходы, в том числе и расходы на перемещение возвращенного товара на нашем складе.

#### ЦЕНЫ

Цены, указанные в наших прайс-листах, не являются для нас обязательными. Мы оставляем за собой право изменить цены перед принятием заказа. При отсутствии иных письменных договоренностей согласованные для каждой отдельной сделки цены подразумеваются как цена-нетто, за наличный расчет и на условиях поставки франко-завод. Если с момента заказа (даже после его подтверждения) до момента поставки повысятся цены на сырье, рабочую силу, топливо, производственные и транспортные затраты и т.д., то La Fabbrica S.p.A. имеет право увеличить согласованную цену, отправив письменное уведомление покупателю. Тем не менее, если новая цена превышает согласованную в заказе более, чем на 20%, то покупатель имеет право на расторжение договора, сообщив нам в письменной форме о своем намерении в 10-дневный срок с момента получения уведомления о повышении цены. При отсутствии сообщения о расторжении новая цена считается принятой.

#### ОПЛАТА

Оплата должна выполняться лишь только в наших офисах. Оплата агентам, представителям или торговым помощникам компании La Fabbrica S.p.A. не считается выполненной до тех пор, пока соответствующие суммы не будут получены компанией La Fabbrica S.p.A.. Любая задержка или отклонение от согласованных условий является признаком неплатежеспособности и предоставляет компании La Fabbrica S.p.A. право приостановить поставку, отменить все текущие контракты, а также немедленно потребовать полной выплаты каждой задолженности через суд в исполнительном или предупредительном порядке, а также потребовать возмещения ущерба. В любом случае, с момента истечения срока оплаты и без необходимости направления официального предупреждения La Fabbrica S.p.A. имеет право на проценты по задолженности, начисленные в такой мере, которая предусмотрена декретом-законом N° 231 от 09/10/2002 г.

#### СЛУЖБА ДОСТАВКИ ДО САССУОЛО

Компания La Fabbrica S.p.A. предоставляет услуги доставки в экспедиторские компании Сассуоло и окрестностей, за которые La Fabbrica S.p.A. взимает плату, зависящую от веса отправляемого груза.

#### СОХРАНЕНИЕ ПРАВА СОБСТВЕННОСТИ

Даже если материал отправлен и за него выставлен счет, он остается в нашей собственности вплоть до полной оплаты поставки, как предусматривается положениями ст. 1523 и последующих Гражданского кодекса о сохранении права собственности.

#### УСТУПКА КОНТРАКТНЫХ ПРАВ

Покупатель не может уступить свои права в контракте или же в отдельных вытекающих из него обязательных отношениях без письменного согласия La Fabbrica S.p.A.. Также и в этом случае покупатель все равно несет полную ответственность вместе с правопреемником за уступленные обязательства.

#### ЗАПРЕТ НА ЭКСПОРТ

La Fabbrica S.p.A. является обладателем и законным держателем эксклюзивных прав на бренды. Чтобы эти права соблюдались наилучшим образом, La Fabbrica S.p.A. выполняет поставки своей продукции посредством системы избирательной дистрибуции. Эти поставки предназначаются для укладки продукции на объектах конечного потребителя. Поэтому, запрещается какой-либо тип перепродажи другому субъекту торговли без письменного разрешения компании La Fabbrica S.p.A.. Нарушение вышесказанного может считаться приравненным к незаконному использованию интеллектуальной и промышленной собственности компании La Fabbrica S.p.A. с вытекающим из этого ее правом потребовать конфискации у любого держателя. Компания La Fabbrica оставляет за собой право подавать иск на всех, кто вовлечен в неразрешенную перепродажу ее продукции. При отсутствии иных договоренностей покупателю запрещается экспортировать нашу продукцию, являющуюся предметом поставки.

#### ОБРАЗЦЫ ПРОДУКЦИИ

Данные, приведенные в рекламных документах компании La Fabbrica S.p.A., а также характеристики образцов, представленные компанией Покупателю, имеют ориентировочный характер. Данная информация не носит обязывающий характер, если только она не была специально указана как обязывающая в коммерческом предложении или в письменном подтверждении компании La Fabbrica S.p.A..

#### КОМПЕТЕНТНЫЙ СУД

Контракт регулируется итальянским законодательством, для решения любых споров единственным компетентным судом будет являться суд Равенны.

# Note generiche sui prodotti

General information on the products . Notes generales sur les produits .

Allgemeineangaben zu den produkten . Notas generales sobre los productos . Общие сведения о продукции .

General information on the products . Notes generales sur les produits .

Allgemeineangaben zu den produkten . Notas generales sobre los productos . Общие сведения о продукции .

- 1. Le cromie, le strutture e le grafiche delle piastrelle riprodotte nelle immagini del catalogo potrebbero non corrispondere fedelmente al prodotto industriale.**  
The colours, structures, and patterns of the tiles illustrated in the catalogue might not correspond exactly to the actual product.  
Les tonalités, les structures et les graphismes des carreaux reproduits sur les images du catalogue pourraient ne pas correspondre fidèlement au produit industriel.  
Es ist möglich, dass die im Katalog abgebildeten Fliesen in Bezug auf Farbton, Struktur und Grafik vom Industrieerzeugnis abweichen.  
Las estructuras, los colores y las gráficas de las baldosas reproducidas en las imágenes del catálogo podrían no coincidir fielmente con el producto industrial.  
Описание оттенков цвета, структура и графическое изображение на плитках, которые напечатаны в каталоге могут не соответствовать действительному промышленному продукту.

- 2. La tonalità del colore della piastrella nelle finiture liscia e strutturata potrebbe essere leggermente dissimile.**  
The colour shading of smooth and structured finishing may vary slightly.  
La tonalité de la couler du carreau dans les finitions lisses et structurées peut être légèrement différente.  
Bei der Farbtonung von Fliesen mit glatter oder mit strukturierter Oberfläche kann es zu leichten Abweichungen kommen.  
Las tonalidades del color de la baldosa en los acabados lisa y estructurada podrían ser ligeramente diferentes.  
Цветовъхе оттенки плитки с гладкой и структурированной поверхностью могут слегка отличаться.

- 3. In caso di posa modulare il grado di stonalizzazione del pavimento potrebbe aumentare rispetto ad una posa monoformato.**  
On pattern sizes floors the shading may result being more intense than on a single format floor.  
En cas de pose modulaire, le degré de tonalisation du carrelage pourrait augmenter par rapport à une pose monoformat.  
Bei der Modulverlegung könnte sich der Grad der Tonalisierung im Vergleich zur Verlegung nur eines Fliesenformates erhöhen.  
En caso de colocación modular el grado de variación cromática del pavimento podría aumentar respecto de una colocación monoformato.  
При укладке плитки разныхЪх форматов степень тонирования пола может увеличиться по сравнению с полом, въ 1ложенъЪм плиткой одного формата.

- 4. Tutti i decori si abbinano al fondo ma possono essere di tonalità diverse.**  
All decorations match the base but may be of a different tone.  
Tous les décors sont assortis au fond, mais les tonalités peuvent être différentes.  
Alle Dekore passen zum Untergrund, können jedoch unterschiedliche Farbtöne aufweisen.  
Todas las decoraciones se combinan con el fondo pero pueden ser de tonalidades diferentes.  
Все декоры сочетаются с фоновой плиткой, но могут быть разных тонов.

- 5. Decori con vetro e graniglie. Le decorazioni mediante l’applicazione dei vetri e delle graniglie vetrose sulle piastrelle ceramiche possono presentare delle irregolarità nella distribuzione di dette graniglie, questo non pregiudica l’effetto estetico del prodotto, ma anzi ne esalta le caratteristiche.**  
Decors with glass and glass-grit. The decors produced by the application of glass and glass grit on ceramic tiles may have an irregular distribution when utilising the glass grit.  
This technique does not compromise the aesthetic effect of the decor and moreover it does enhance its technical features.

Décors avec pâtes de verre. Les décors fabriqués en appliquant des pâtes de verre sur les carreaux céramiques peuvent réserter une distribution irrégulière de ces pâtes; ceci n’empêche pas l’effet esthétique du décor, mais au contraire améliore ses caractéristiques.

Dekore mit Buntglas und Spliteinstellungen. Diese serie ist dekoriert mit buntglas und spliteinstellungen. Bei der Anwendung dieser körnigen Glas Split Anteile, können optische, so wie strukturelle Unregelmäßigkeiten bei der Verteilung in der Oberfläche auftreten. Dies gilt als gewünschter Effekt, zur zusätzlichen ästhetische Aufwertung des Produkts.

Decorado con vidrio y granillas. Unas de las características de los decorados de La Fabbrica S.p.A., son muchas de las irregularidades creadas con efectos de granillas y vidrios, que podrían ser un defectos estéticos, pero al final, son el valor añadido del desarrollo cerámico.

Декоры со стеклом и стеклянной крошкой. Декорирование посредством нанесения стекла и стеклянной крошки на керамическую плитку может иметь неравномерность в распределении стеклянной крошки, это не только не ухудшает эстетический эффект продукта, а наоборот превозносит его характеристики.

- 6. I pesi riportati in tabella sono indicativi in quanto possono subire leggere variazioni per motivi produttivi.**  
The weights stated in the chart are approximate as some changes may be necessary for production reasons.  
Les poids figurant dans le tableau sont fournis à titre indicatif car ils peuvent subir de légères variations pour des raisons de production.  
Die in der Tabelle aufgeführten Gewichte sind nicht bindend, da sie aus Produktionsgründen leichte Änderungen aufweisen können.  
Los pesos señalados en la tabla son aproximados ya que pueden experimentar ligeras variaciones por motivos productivos.  
Указанный в таблице вес является приблизительным, так как ввиду производственных необходимостей, он может слегка измениться.

- 7. Per il gradino non si garantisce la stessa tonalità del fondo.**  
We cannot guarantee that the shade of the stair tile will be the same as the background tile.  
Pour la marche, nous ne garantissons pas la même tonalité du fond.  
Für die Stufe wird nicht der gleiche Farbton der Grundfliese garantiert.  
Para el peldaño no se garantiza el mismo tono del fondo.  
Для ступени не гарантирована одинаковость тона с фоном.

- 8. Tra i fondi di spessore 10 e 20 mm non si garantisce l’abbinabilità.**  
We cannot guarantee tonal matches between the same background tiles with different thickness (10 or 20 mm).  
Les assortiments des tons ne sont pas garantis pour les fonds d’une épaisseur de 10 et 20 mm.  
Bei Bodenfliesen mit einer Stärke von 10 und 20 mm wird keine Einheitlichkeit der Farbtöne garantiert.  
Para los fondos de espesor 10 y 20 mm no se garantiza la combinabilidad de tonalidades.  
Для фоновой плитки толщиной 10 и 20 мм не гарантирована цветовая сочетаемость.

# Certificazioni di prodotto

Product certification . Certification de produit .

Produkt Zertifizierungen . Certificaciones de producto . Цертификация .

Product certification . Certification de produit .

Produkt Zertifizierungen . Certificaciones de producto . Цертификация .

- AGGLOMERATE  
AMAZON  
ARDESIA  
ARTILE  
BORCHI ITALIANI  
BLUE EVOLUTION  
BRUSH  
CA' FOSCARI  
CASTLE

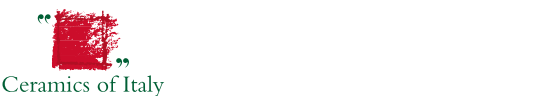

- CHROMATIC  
COTTO DEL CASALE  
DOLOMITI  
FUSION  
HIGH LINE  
IL CERRETO  
IMPERIAL  
I QUARZI  
JUNGLE STONE



- KAURI  
LASCAUX  
LE PIETRE D'EUROPA  
MARM  
PIERRES DES CHATEAUX

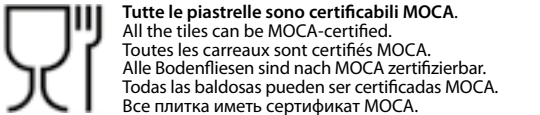

- PIETRA LAVICA  
PIETRE MILIARI  
RA-KU  
RESINE  
ROYAL STONE  
SPACE

- STEELISTIC  
STORM  
YOSEMITE

- DOLOMITI  
HIGH LINE  
I QUARZI  
KAURI  
LASCAUX  
PIETRA LAVICA  
SPACE  
STORM



- I QUARZI



- SPACE

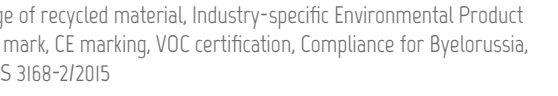

- Attestazione della percentuale di riciclato, Dichiarazione Ambientale di prodotto settoriale, UPEC, Marchio CCC, Marcatura CE, Certificazione VOC-COV, Conformità Bielorussia, Conformità Egitto ES 3168-2/2015

- Certificate of percentage of recycled material, Industry-specific Environmental Product Declaration, UPEC, CCC mark, CE marking, VOC certification, Compliance for Byelorussia, Compliance for Egypt ES 3168-2/2015

- Attestation du pourcentage de matériel recyclé, Déclaration environnementale de produit sectoriel, UPEC, Label CCC, Marquage CE, certification VOC-COV, conformité Biélorussie, conformité Égypte ES 3168-2/2015

- Bescheinigung des Anteils von Recycling-Produkten, Umweltschutz-Erklärung der Produkte nach Bereichen, UPEC, CCC-Kennzeichnung, CE-Kennzeichnung, VOC-COV-Zertifizierung, Konformität für Weißrussland, Ägypten ES 3168-2/2015

- Certificación del porcentaje de reciclado, Declaración Ambiental de producto sectorial, UPEC, Marcación CCC, Marcación CE, Certificación VOC-COV, Conformidad Bielorrusia, Conformidad Egipto ES 3168-2/2015

- Сертификат процентного содержания переработанного материала, отраслевая экологическая декларация продукции, сертификат UPEC, знак CCC, маркировка CE, сертификат ЛОС, сертификат соответствия РБ, египетский сертификат соответствия ES 3168-2/2015

Product certification . Certification de produit .

Produkt Zertifizierungen . Certificaciones de sistema . Системная сертификация

Product certification . Certification de produit .

Produkt Zertifizierungen . Certificaciones de sistema . Системная сертификация

Product certification . Certification de produit .

Produkt Zertifizierungen . Certificaciones de sistema . Системная сертификация



Product certification . Certification de produit .

Produkt Zertifizierungen . Certificaciones de sistema . Системная сертификация

Consulta il sito [www.lafabbrica.it](http://www.lafabbrica.it) per vedere gli ultimi aggiornamenti.  
Check out our website at [www.lafabbrica.it](http://www.lafabbrica.it) for the latest updates.  
Consultez le site [www.lafabbrica.it](http://www.lafabbrica.it) pour connaître les dernières mises à jour.  
Auf der Website [www.lafabbrica.it](http://www.lafabbrica.it) finden Sie die neuesten Informationen.  
Consulta el sitio [www.lafabbrica.it](http://www.lafabbrica.it) para ver las últimas actualizaciones.  
Зайдите на сайт [www.lafabbrica.it](http://www.lafabbrica.it), чтобы увидеть последние новинки.

AD: **Omniadvert S.p.A.**  
**Marketing La Fabbrica**  
Print: **Faenza Group SpA**  
Edizione I - Gennaio 2021

La Fabbrica S.p.A. si riserva di apportare, senza alcun preavviso, le modifiche che riterrà più opportune al fine di migliorare il prodotto.  
Quanto riportato è da considerarsi indicativo e non esaustivo in riferimento ai colori e alle caratteristiche estetiche dei prodotti.

La Fabbrica S.p.A. reserves the right to make any changes it deems fit in order to improve the product, without prior notice.  
All images are provided for illustrative purposes only and other colours and aesthetic features are available.

La Fabbrica S.p.A. se réserve le droit d'apporter, sans préavis, les modifications qu'elle jugera opportunes afin d'améliorer le produit.  
Les informations ci-dessus sont fournies à titre indicatif et elles ne sont pas contraignantes en ce qui concerne les couleurs et les caractéristiques esthétiques des produits.

Die Firma La Fabbrica S.p.A. behält sich vor, ohne jegliche vorherige Ankündigung jene Änderungen vorzunehmen, die sie zur Verbesserung des Produktes für angebracht hält.  
Die Angaben sind bezüglich der Farben und ästhetischen Eigenschaften der Produkte als Richtwerte und nicht als vollständig anzusehen.

La Fabbrica S.p.A. se reserva la posibilidad de introducir, sin obligación de aviso previo, las modificaciones que considere más indicadas para mejorar el producto.  
Las cualidades del material presentado deben considerarse de modo genérico, no siendo exhaustivas en cuanto a los colores y a las características estéticas de los productos.

La Fabbrica S.p.A. оставляет за собой право на внесение без предварительного уведомления изменений, которые она считает целесообразными для улучшения продукции.  
Приведенные указания должны считаться ориентировочными и не исчерпывающими в том, что касается цветов и эстетических характеристик продукции.



Civilization of Beauty

FOLLOW US

